

Introduction to Quantum Mechanics

David J. Griffiths

Reed College

Prentice Hall
Upper Saddle River, New Jersey 07458

Fundamental Equations

Schrödinger equation:

$$i\hbar \frac{\partial \Psi}{\partial t} = H\Psi$$

Time independent Schrödinger equation:

$$H\psi = E\psi, \quad \Psi = \psi e^{-iEt/\hbar}$$

Standard Hamiltonian:

$$H = -\frac{\hbar^2}{2m} \nabla^2 + V$$

Time dependence of an expectation value:

$$\frac{d\langle Q \rangle}{dt} = \frac{i}{\hbar} \langle [H, Q] \rangle + \left\langle \frac{\partial Q}{\partial t} \right\rangle$$

Generalized uncertainty principle:

$$\sigma_A \sigma_B \geq \left| \frac{1}{2i} \langle [A, B] \rangle \right|^2$$

Heisenberg uncertainty principle:

$$\sigma_x \sigma_p \geq \hbar/2$$

Canonical commutator:

$$[x, p] = i\hbar$$

Angular momentum:

$$[L_x, L_y] = i\hbar L_z, \quad [L_y, L_z] = i\hbar L_x, \quad [L_z, L_x] = i\hbar L_y$$

Pauli matrices:

$$\sigma_x = \begin{pmatrix} 0 & 1 \\ 1 & 0 \end{pmatrix}, \quad \sigma_y = \begin{pmatrix} 0 & -i \\ i & 0 \end{pmatrix}, \quad \sigma_z = \begin{pmatrix} 1 & 0 \\ 0 & -1 \end{pmatrix}$$

Fundamental Constants

| | | | | |
|-------------------------|--------------|---|----------------------------|---------------------|
| Planck's constant : | \hbar | = | 1.05457×10^{-34} | J s |
| Speed of light : | c | = | 2.99792×10^8 | m/s |
| Mass of electron : | m_e | = | 9.10939×10^{-31} | kg |
| Mass of proton : | m_p | = | 1.67262×10^{-27} | kg |
| Charge of electron : | $-e$ | = | -1.60218×10^{-19} | C |
| Permittivity of space : | ϵ_0 | = | 8.85419×10^{-12} | C ² /J m |
| Boltzmann constant : | k_B | = | 1.38066×10^{-23} | J/K |

Hydrogen Atom

| | | | | | |
|---------------------------|---------------------|---|--|---|-----------------------------|
| Fine structure constant : | α | = | $e^2/4\pi\epsilon_0\hbar c$ | = | 1/137.036 |
| Bohr radius : | a | = | $4\pi\epsilon_0\hbar^2/m_e e^2 = \hbar/\alpha m_e c$ | = | 5.29177×10^{-11} m |
| Bohr energies : | E_n | = | E_1/n^2 ($n = 1, 2, 3, \dots$) | | |
| Ground state energy : | $-E_1$ | = | $m_e e^4/2(4\pi\epsilon_0)^2 \hbar^2 = \alpha^2 m_e c^2/2$ | = | 13.6057 eV |
| Wave function : | ψ_0 | = | $\frac{1}{\sqrt{\pi a^3}} e^{-r/a}$ | | |
| Rydberg formula : | $\frac{1}{\lambda}$ | = | $R \left(\frac{1}{n_f^2} - \frac{1}{n_i^2} \right)$ | | |
| Rydberg constant : | R | = | $-E_1/2\pi\hbar c$ | = | 1.09737×10^7 /m |

Library of Congress Cataloging-in-Publication Data

Griffiths, David J. (David Jeffrey)

Introduction to quantum mechanics / David J. Griffiths.

p. cm.

Includes bibliographical references and index.

ISBN 0-13-124405-1

1. Quantum theory. I. Title.

QC174.12.G75 1994

530.1'2—dc20

94-14133

CIP

Acquisitions Editor: Ray Henderson
Assistant Acquisition Editor: Wendy Rivers
Editorial Assistant: Pam Holland-Moritz
Production Editors: Rose Kernan and Fred Dahl
Copy Editor: Rose Kernan
Production Coordinator: Trudy Piscioti

© 1995 by Prentice Hall, Inc.
Upper Saddle River, NJ 07458

All rights reserved. No part of this book may be reproduced, in any form or by any means, without permission in writing from the publisher.

Printed in the United States of America

10

ISBN 0-13-124405-1

Prentice-Hall International (UK) Limited, *London*
Prentice-Hall of Australia Pty. Limited, *Sydney*
Prentice-Hall of Canada, Inc., *Toronto*
Prentice-Hall Hispanoamericana, S. A., *Mexico*
Prentice-Hall of India Private Limited, *New Delhi*
Prentice-Hall of Japan, Inc., *Tokyo*
Pearson Education Asia Pte. Ltd., *Singapore*
Editora Prentice-Hall do Brasil, Ltda., *Rio de Janeiro*

ISBN 0-13-124405-1

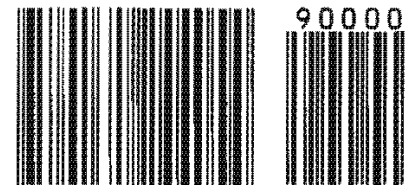

9 780131 244054

CONTENTS

PREFACE, vii

PART I THEORY

CHAPTER 1 THE WAVE FUNCTION, 1

- 1.1 The Schrodinger Equation, 1*
- 1.2 The Statistical Interpretation, 2*
- 1.3 Probability, 5*
- 1.4 Normalization, 11*
- 1.5 Momentum, 14*
- 1.6 The Uncertainty Principle, 17*

CHAPTER 2 THE TIME-INDEPENDENT SCHRODINGER EQUATION, 20

- 2.1 Stationary States, 20*
- 2.2 The Infinite Square Well, 24*
- 2.3 The Harmonic Oscillator, 31*
- 2.4 The Free Particle, 44*
- 2.5 The Delta-Function Potential, 50*
- 2.6 The Finite Square Well, 60*

- 2.7 *The Scattering Matrix*, 66
- Further Problems for Chapter 2*, 68

CHAPTER 3
FORMALISM, 75

- 3.1 *Linear Algebra*, 75
- 3.2 *Function Spaces*, 95
- 3.3 *The Generalized Statistical Interpretation*, 104
- 3.4 *The Uncertainty Principle*, 108
- Further Problems for Chapter 3*, 116

CHAPTER 4
QUANTUM MECHANICS IN THREE DIMENSIONS, 121

- 4.1 *Schrodinger Equations in Spherical Coordinates*, 121
- 4.2 *The Hydrogen Atom*, 133
- 4.3 *Angular Momentum*, 145
- 4.4 *Spin*, 154
- Further Problems for Chapter 4*, 170

CHAPTER 5
IDENTICAL PARTICLES, 177

- 5.1 *Two-Particle Systems*, 177
- 5.2 *Atoms*, 186
- 5.3 *Solids*, 193
- 5.4 *Quantum Statistical Mechanics*, 204
- Further Problems for Chapter 5*, 218

PART II
APPLICATIONS

CHAPTER 6
TIME-INDEPENDENT PERTURBATION THEORY, 221

- 6.1 *Nondegenerate Perturbation Theory*, 221
- 6.2 *Degenerate Perturbation Theory*, 227
- 6.3 *The Fine Structure of Hydrogen*, 235
- 6.4 *The Zeeman Effect*, 244
- 6.5 *Hyperfined Splitting*, 250
- Further Problems for Chapter 6*, 252

CHAPTER 7
THE VARIATIONAL PRINCIPLE, 256

- 7.1 Theory, 256*
- 7.2 The Ground State of Helium, 261*
- 7.3 The Hydrogen Molecule Ion, 266*
- Further Problems for Chapter 7, 271*

CHAPTER 8
THE WKB APPROXIMATION, 274

- 8.1 The “Classical” Region, 275*
- 8.2 Tunneling, 280*
- 8.3 The Connection Formulas, 284*
- Further Problems for Chapter 8, 293*

CHAPTER 9
TIME-DEPENDENT PERTURBATION THEORY, 298

- 9.1 Two-Level Systems, 299*
- 9.2 Emission and Absorption of Radiation, 306*
- 9.3 Spontaneous Emission, 311*
- Further Problems for Chapter 9, 319*

CHAPTER 10
THE ADIABATIC APPROXIMATION, 323

- 10.1 The Adiabatic Theorem, 323*
- 10.2 Berry's Phase, 333*
- Further Problems for Chapter 10, 349*

CHAPTER 11
SCATTERING, 352

- 11.1 Introduction, 352*
- 11.2 Partial Wave Analysis, 357*
- 11.3 The Born Approximation, 363*
- Further Problems for Chapter 11, 373*

AFTERWORD, 374

INDEX, 386

PREFACE

Unlike Newton's mechanics, or Maxwell's electrodynamics, or Einstein's relativity, quantum theory was not created—or even definitively packaged—by one individual, and it retains to this day some of the scars of its exhilarating but traumatic youth. There is no general consensus as to what its fundamental principles are, how it should be taught, or what it really “means.” Every competent physicist can “do” quantum mechanics, but the stories we tell ourselves about what we are doing are as various as the tales of Scheherazade, and almost as implausible. Richard Feynman (one of its greatest practitioners) remarked, “I think I can safely say that nobody understands quantum mechanics.”

The purpose of this book is to teach you how to *do* quantum mechanics. Apart from some essential background in Chapter 1, the deeper quasi-philosophical questions are saved for the end. I do not believe one can intelligently discuss what quantum mechanics *means* until one has a firm sense of what quantum mechanics *does*. But if you absolutely cannot wait, by all means read the Afterword immediately following Chapter 1.

Not only is quantum theory conceptually rich, it is also technically difficult, and exact solutions to all but the most artificial textbook examples are few and far between. It is therefore essential to develop special techniques for attacking more realistic problems. Accordingly, this book is divided into two parts¹; Part I covers the basic theory, and Part II assembles an arsenal of approximation schemes, with illustrative applications. Although it is important to keep the two parts logically separate, it is not necessary to study the material in the order presented here. Some instructors, for example, may wish to treat time-independent perturbation theory immediately after Chapter 2.

¹This structure was inspired by David Park's classic text *Introduction to the Quantum Theory*, 3rd ed., (New York: McGraw-Hill, 1992).

This book is intended for a one-semester or one-year course at the junior or senior level. A one-semester course will have to concentrate mainly on Part I; a full-year course should have room for supplementary material beyond Part II. The reader must be familiar with the rudiments of linear algebra, complex numbers, and calculus up through partial derivatives; some acquaintance with Fourier analysis and the Dirac delta function would help. Elementary classical mechanics is essential, of course, and a little electrodynamics would be useful in places. As always, the more physics and math you know the easier it will be, and the more you will get out of your study. But I would like to emphasize that quantum mechanics is not, in my view, something that flows smoothly and naturally from earlier theories. On the contrary, it represents an abrupt and revolutionary departure from classical ideas, calling forth a wholly new and radically counterintuitive way of thinking about the world. That, indeed, is what makes it such a fascinating subject.

At first glance, this book may strike you as forbiddingly mathematical. We encounter Legendre, Hermite, and Laguerre polynomials, spherical harmonics, Bessel, Neumann, and Hankel functions, Airy functions, and even the Riemann Zeta function—not to mention Fourier transforms, Hilbert spaces, Hermitian operators, Clebsch-Gordan coefficients, and Lagrange multipliers. Is all this baggage really necessary? Perhaps not, but physics is like carpentry: Using the right tool makes the job *easier*, not more difficult, and teaching quantum mechanics without the appropriate mathematical equipment is like asking the student to dig a foundation with a screwdriver. (On the other hand, it can be tedious and diverting if the instructor feels obliged to give elaborate lessons on the proper use of each tool. My own instinct is to hand the students shovels and tell them to start digging. They may develop blisters at first, but I still think this is the most efficient and exciting way to learn.) At any rate, I can assure you that there is no *deep* mathematics in this book, and if you run into something unfamiliar, and you don't find my explanation adequate, by all means *ask* someone about it, or look it up. There are many good books on mathematical methods—I particularly recommend Mary Boas, *Mathematical Methods in the Physical Sciences*, 2nd ed., Wiley, New York (1983), and George Arfken, *Mathematical Methods for Physicists*, 3rd ed., Academic Press, Orlando (1985). But whatever you do, don't let the mathematics—which, for us, is only a tool—interfere with the physics.

Several readers have noted that there are fewer worked examples in this book than is customary, and that some important material is relegated to the problems. This is no accident. I don't believe you can learn quantum mechanics without doing many exercises for yourself. Instructors should, of course, go over as many problems in class as time allows, but students should be warned that this is not a subject about which *anyone* has natural intuitions—you're developing a whole new set of muscles here, and there is simply no substitute for calisthenics. Mark Semon suggested that I offer a "Michelin Guide" to the problems, with varying numbers of stars to indicate the level of difficulty and importance. This seemed like a good idea (though, like the quality of a restaurant, the significance of a problem is partly a matter of taste); I have adopted the following rating scheme:

- * an essential problem that every reader should study;
- ** a somewhat more difficult or more peripheral problem;
- *** an unusually challenging problem that may take over an hour.

(No stars at all means fast food: OK if you're hungry, but not very nourishing.) Most of the one-star problems appear at the end of the relevant section; most of the three-star problems are at the end of the chapter. A solution manual is available (to instructors only) from the publisher.

I have benefited from the comments and advice of many colleagues, who suggested problems, read early drafts, or used a preliminary version in their courses. I would like to thank in particular Burt Brody (Bard College), Ash Carter (Drew University), Peter Collings (Swarthmore College), Jeff Dunham (Middlebury College), Greg Elliott (University of Puget Sound), Larry Hunter (Amherst College), Mark Semon (Bates College), Stavros Theodorakis (University of Cyprus), Dan Velleman (Amherst College), and all my colleagues at Reed College.

Finally, I wish to thank David Park and John Rasmussen (and their publishers) for permission to reproduce Figure 8.6, which is taken from Park's *Introduction to the Quantum Theory* (footnote 1), adapted from I. Perlman and J. O. Rasmussen, "Alpha Radioactivity," in *Encyclopedia of Physics*, vol. 42, Springer-Verlag, 1957.

PART I

THEORY

CHAPTER 1

THE WAVE FUNCTION

1.1 THE SCHRÖDINGER EQUATION

Imagine a particle of mass m , constrained to move along the x -axis, subject to some specified force $F(x, t)$ (Figure 1.1). The program of *classical* mechanics is to determine the position of the particle at any given time: $x(t)$. Once we know that, we can figure out the velocity ($v = dx/dt$), the momentum ($p = mv$), the kinetic energy ($T = (1/2)mv^2$), or any other dynamical variable of interest. And how do we go about determining $x(t)$? We apply Newton's second law: $F = ma$. (For conservative systems—the only kind we shall consider, and, fortunately, the only kind that *occur* at the microscopic level—the force can be expressed as the derivative of a potential energy function,¹ $F = -\partial V/\partial x$, and Newton's law reads $m d^2x/dt^2 = -\partial V/\partial x$.) This, together with appropriate initial conditions (typically the position and velocity at $t = 0$), determines $x(t)$.

Quantum mechanics approaches this same problem quite differently. In this case what we're looking for is the **wave function**, $\Psi(x, t)$, of the particle, and we get it by solving the **Schrödinger equation**:

$$i\hbar \frac{\partial \Psi}{\partial t} = -\frac{\hbar^2}{2m} \frac{\partial^2 \Psi}{\partial x^2} + V\Psi. \quad [1.1]$$

¹Magnetic forces are an exception, but let's not worry about them just yet. By the way, we shall assume throughout this book that the motion is nonrelativistic ($v \ll c$).

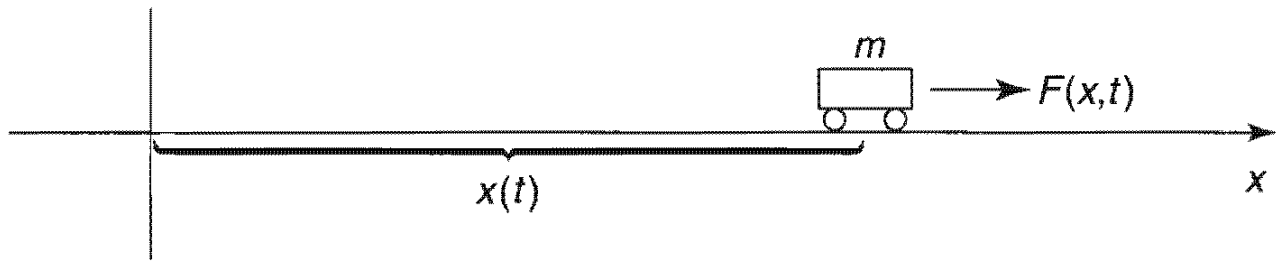

Figure 1.1: A “particle” constrained to move in one dimension under the influence of a specified force.

Here i is the square root of -1 , and \hbar is Planck’s constant—or rather, his original constant (h) divided by 2π :

$$\hbar = \frac{h}{2\pi} = 1.054573 \times 10^{-34} \text{ J s.} \quad [1.2]$$

The Schrödinger equation plays a role logically analogous to Newton’s second law: Given suitable initial conditions [typically, $\Psi(x, 0)$], the Schrödinger equation determines $\Psi(x, t)$ for all future time, just as, in classical mechanics, Newton’s law determines $x(t)$ for all future time.

1.2 THE STATISTICAL INTERPRETATION

But what exactly *is* this “wave function”, and what does it do for you once you’ve got it? After all, a particle, by its nature, is localized at a point, whereas the wave function (as its name suggests) is spread out in space (it’s a function of x , for any given time t). How can such an object be said to describe the state of a *particle*? The answer is provided by Born’s **statistical interpretation** of the wave function, which says that $|\Psi(x, t)|^2$ gives the *probability* of finding the particle at point x , at time t —or, more precisely,²

$$|\Psi(x, t)|^2 dx = \left\{ \begin{array}{l} \text{probability of finding the particle} \\ \text{between } x \text{ and } (x + dx), \text{ at time } t. \end{array} \right\} \quad [1.3]$$

For the wave function in Figure 1.2, you would be quite likely to find the particle in the vicinity of point A , and relatively unlikely to find it near point B .

The statistical interpretation introduces a kind of **indeterminacy** into quantum mechanics, for even if you know everything the theory has to tell you about the

²The wave function itself is complex, but $|\Psi|^2 = \Psi^* \Psi$ (where Ψ^* is the complex conjugate of Ψ) is real and nonnegative—as a probability, of course, must be.

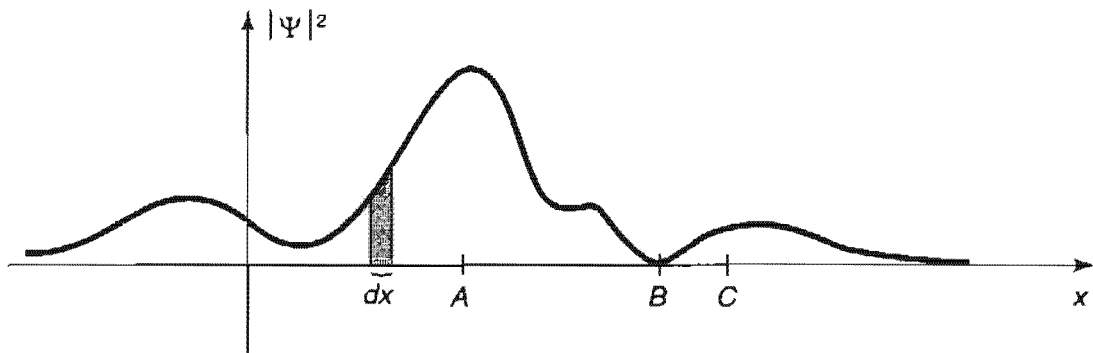

Figure 1.2: A typical wave function. The particle would be relatively likely to be found near A , and unlikely to be found near B . The shaded area represents the probability of finding the particle in the range dx .

particle (to wit: its wave function), you cannot predict with certainty the outcome of a simple experiment to measure its position—all quantum mechanics has to offer is *statistical* information about the *possible* results. This indeterminacy has been profoundly disturbing to physicists and philosophers alike. Is it a peculiarity of nature, a deficiency in the theory, a fault in the measuring apparatus, or *what*?

Suppose I *do* measure the position of the particle, and I find it to be at the point C . Question: Where was the particle just *before* I made the measurement? There are three plausible answers to this question, and they serve to characterize the main schools of thought regarding quantum indeterminacy:

1. The **realist** position: *The particle was at C .* This certainly seems like a sensible response, and it is the one Einstein advocated. Note, however, that if this is true then quantum mechanics is an **incomplete** theory, since the particle *really* was at C , and yet quantum mechanics was unable to tell us so. To the realist, indeterminacy is not a fact of nature, but a reflection of our ignorance. As d'Espagnat put it, "the position of the particle was never indeterminate, but was merely unknown to the experimenter."³ Evidently Ψ is not the whole story—some additional information (known as a **hidden variable**) is needed to provide a complete description of the particle.

2. The **orthodox** position: *The particle wasn't really anywhere.* It was the act of measurement that forced the particle to "take a stand" (though how and why it decided on the point C we dare not ask). Jordan said it most starkly: "Observations not only *disturb* what is to be measured, they *produce* it. . . . We *compel* [the particle] to assume a definite position."⁴ This view (the so-called **Copenhagen interpretation**) is associated with Bohr and his followers. Among physicists it has always been the

³Bernard d'Espagnat, *The Quantum Theory and Reality*, Scientific American, Nov. 1979 (Vol. 241), p. 165.

⁴Quoted in a lovely article by N. David Mermin, *Is the moon there when nobody looks?*, Physics Today, April 1985, p. 38.

most widely accepted position. Note, however, that if it is correct there is something very peculiar about the act of measurement—something that over half a century of debate has done precious little to illuminate.

3. The **agnostic** position: *Refuse to answer*. This is not quite as silly as it sounds—after all, what sense can there be in making assertions about the status of a particle *before* a measurement, when the only way of knowing whether you were right is precisely to conduct a measurement, in which case what you get is no longer “before the measurement”? It is metaphysics (in the perjorative sense of the word) to worry about something that cannot, by its nature, be tested. Pauli said, “One should no more rack one’s brain about the problem of whether something one cannot know anything about exists all the same, than about the ancient question of how many angels are able to sit on the point of a needle.”⁵ For decades this was the “fall-back” position of most physicists: They’d try to sell you answer 2, but if you were persistent they’d switch to 3 and terminate the conversation.

Until fairly recently, all three positions (realist, orthodox, and agnostic) had their partisans. But in 1964 John Bell astonished the physics community by showing that it makes an *observable* difference if the particle had a precise (though unknown) position prior to the measurement. Bell’s discovery effectively eliminated agnosticism as a viable option, and made it an *experimental* question whether 1 or 2 is the correct choice. I’ll return to this story at the end of the book, when you will be in a better position to appreciate Bell’s theorem; for now, suffice it to say that the experiments have confirmed decisively the orthodox interpretation⁶: A particle simply does not have a precise position prior to measurement, any more than the ripples on a pond do; it is the measurement process that insists on one particular number, and thereby in a sense *creates* the specific result, limited only by the statistical weighting imposed by the wave function.

But what if I made a *second* measurement, immediately after the first? Would I get C again, or does the act of measurement cough up some completely new number each time? On this question everyone is in agreement: A repeated measurement (on the same particle) must return the same value. Indeed, it would be tough to prove that the particle was really found at C in the first instance if this could not be confirmed by immediate repetition of the measurement. How does the orthodox interpretation account for the fact that the second measurement is bound to give the value C ? Evidently the first measurement radically alters the wave function, so that it is now sharply peaked about C (Figure 1.3). We say that the wave function **collapses** upon measurement, to a spike at the point C (Ψ soon spreads out again, in accordance with the Schrödinger equation, so the second measurement must be made quickly). There

⁵Quoted by Mermin (previous footnote), p. 40.

⁶This statement is a little too strong: There remain a few theoretical and experimental loopholes, some of which I shall discuss in the Afterword. And there exist other formulations (such as the **many worlds** interpretation) that do not fit cleanly into any of my three categories. But I think it is wise, at least from a pedagogical point of view, to adopt a clear and coherent platform at this stage, and worry about the alternatives later.

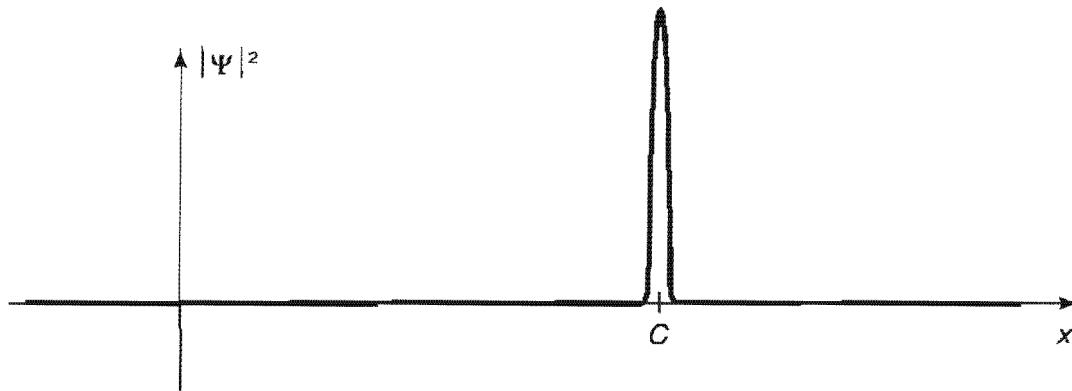

Figure 1.3: Collapse of the wave function: graph of $|\Psi|^2$ immediately after a measurement has found the particle at point C .

are, then, two entirely distinct kinds of physical processes: “ordinary” ones, in which the wave function evolves in a leisurely fashion under the Schrödinger equation, and “measurements”, in which Ψ suddenly and discontinuously collapses.⁷

1.3 PROBABILITY

Because of the statistical interpretation, **probability** plays a central role in quantum mechanics, so I digress now for a brief discussion of the theory of probability. It is mainly a question of introducing some notation and terminology, and I shall do it in the context of a simple example.

Imagine a room containing 14 people, whose ages are as follows:

- one person aged 14
- one person aged 15
- three people aged 16
- two people aged 22
- two people aged 24
- five people aged 25.

If we let $N(j)$ represent the number of people of age j , then

⁷The role of measurement in quantum mechanics is so critical and so bizarre that you may well be wondering what precisely *constitutes* a measurement. Does it have to do with the interaction between a microscopic (quantum) system and a macroscopic (classical) measuring apparatus (as Bohr insisted), or is it characterized by the leaving of a permanent “record” (as Heisenberg claimed), or does it involve the intervention of a conscious “observer” (as Wigner proposed)? I’ll return to this thorny issue in the Afterword; for the moment let’s take the naive view: A measurement is the kind of thing that a scientist does in the laboratory, with rulers, stopwatches, Geiger counters, and so on.

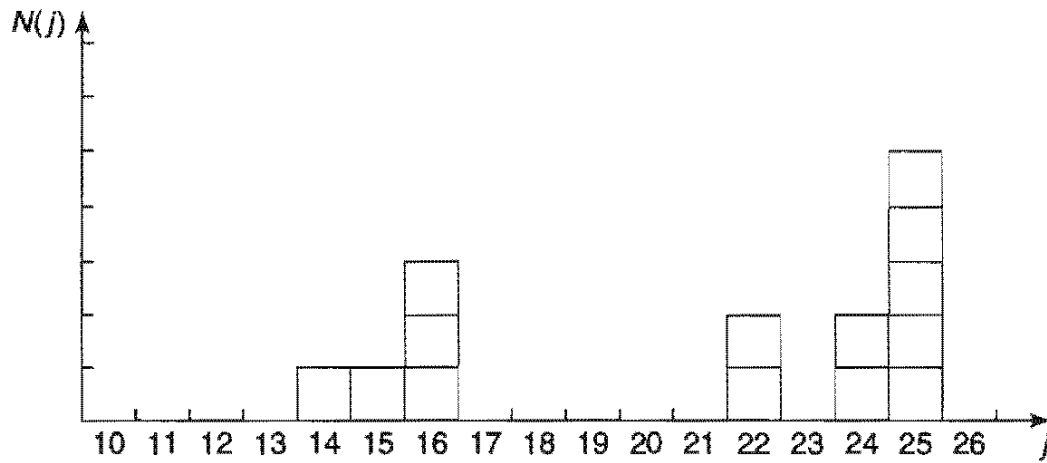

Figure 1.4: Histogram showing the number of people, $N(j)$, with age j , for the example in Section 1.3.

$$N(14) = 1$$

$$N(15) = 1$$

$$N(16) = 3$$

$$N(22) = 2$$

$$N(24) = 2$$

$$N(25) = 5$$

while $N(17)$, for instance, is zero. The *total* number of people in the room is

$$N = \sum_{j=0}^{\infty} N(j). \quad [1.4]$$

(In this instance, of course, $N = 14$.) Figure 1.4 is a histogram of the data. The following are some questions one might ask about this distribution.

Question 1. If you selected one individual at random from this group, what is the **probability** that this person's age would be 15? *Answer:* One chance in 14, since there are 14 possible choices, all equally likely, of whom only one has this particular age. If $P(j)$ is the probability of getting age j , then $P(14) = 1/14$, $P(15) = 1/14$, $P(16) = 3/14$, and so on. In general,

$$P(j) = \frac{N(j)}{N}. \quad [1.5]$$

Notice that the probability of getting *either* 14 *or* 15 is the *sum* of the individual probabilities (in this case, $1/7$). In particular, the sum of *all* the probabilities is 1—you're *certain* to get *some* age:

$$\sum_{j=1}^{\infty} P(j) = 1. \quad [1.6]$$

Question 2. What is the **most probable** age? *Answer:* 25, obviously; five people share this age, whereas at most three have any other age. In general, the most probable j is the j for which $P(j)$ is a maximum.

Question 3. What is the **median** age? *Answer:* 23, for 7 people are younger than 23, and 7 are older. (In general, the median is that value of j such that the probability of getting a larger result is the same as the probability of getting a smaller result.)

Question 4. What is the **average** (or **mean**) age? *Answer:*

$$\frac{(14) + (15) + 3(16) + 2(22) + 2(24) + 5(25)}{14} = \frac{294}{14} = 21.$$

In general, the average value of j (which we shall write thus: $\langle j \rangle$) is given by

$$\langle j \rangle = \frac{\sum jN(j)}{N} = \sum_{j=0}^{\infty} jP(j). \quad [1.7]$$

Notice that there need not be anyone with the average age or the median age—in this example nobody happens to be 21 or 23. In quantum mechanics the average is usually the quantity of interest; in that context it has come to be called the **expectation value**. It's a misleading term, since it suggests that this is the outcome you would be most likely to get if you made a single measurement (*that would be the most probable value*, not the average value)—but I'm afraid we're stuck with it.

Question 5. What is the average of the *squares* of the ages? *Answer:* You could get $14^2 = 196$, with probability $1/14$, or $15^2 = 225$, with probability $1/14$, or $16^2 = 256$, with probability $3/14$, and so on. The average, then, is

$$\langle j^2 \rangle = \sum_{j=0}^{\infty} j^2 P(j). \quad [1.8]$$

In general, the average value of some *function* of j is given by

$$\langle f(j) \rangle = \sum_{j=0}^{\infty} f(j) P(j). \quad [1.9]$$

(Equations 1.6, 1.7, and 1.8 are, if you like, special cases of this formula.) *Beware:* The average of the squares ($\langle j^2 \rangle$) is *not* ordinarily equal to the square of the average ($\langle j \rangle^2$). For instance, if the room contains just two babies, aged 1 and 3, then $\langle x^2 \rangle = 5$, but $\langle x \rangle^2 = 4$.

Now, there is a conspicuous difference between the two histograms in Figure 1.5, even though they have the same median, the same average, the same most probable value, and the same number of elements: The first is sharply peaked about the average value, whereas the second is broad and flat. (The first might represent the age profile for students in a big-city classroom, and the second the pupils in a one-room schoolhouse.) We need a numerical measure of the amount of “spread” in a

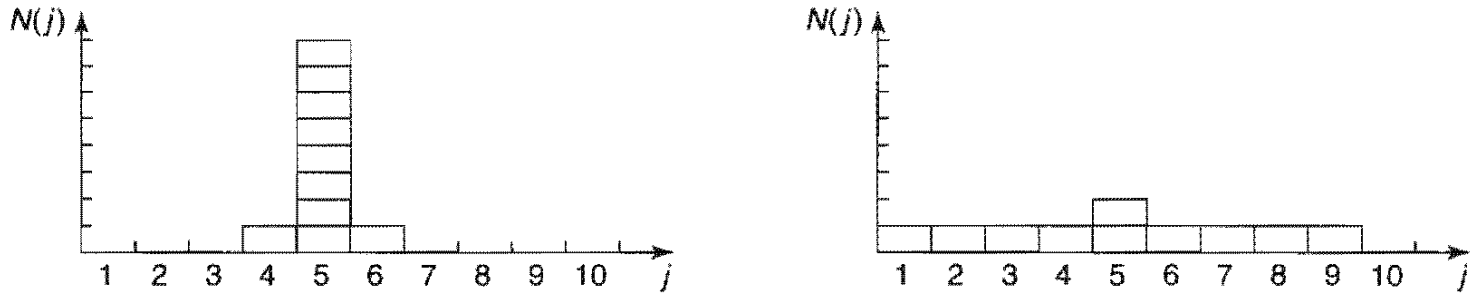

Figure 1.5: Two histograms with the same median, same average, and same most probable value, but different standard deviations.

distribution, with respect to the average. The most obvious way to do this would be to find out how far each individual deviates from the average,

$$\Delta j = j - \langle j \rangle, \quad [1.10]$$

and compute the average of Δj . Trouble is, of course, that you get *zero*, since, by the nature of the average, Δj is as often negative as positive:

$$\begin{aligned} \langle \Delta j \rangle &= \sum (j - \langle j \rangle) P(j) = \sum j P(j) - \langle j \rangle \sum P(j) \\ &= \langle j \rangle - \langle j \rangle = 0. \end{aligned}$$

(Note that $\langle j \rangle$ is constant—it does not change as you go from one member of the sample to another—so it can be taken outside the summation.) To avoid this irritating problem, you might decide to average the *absolute value* of Δj . But absolute values are nasty to work with; instead, we get around the sign problem by *squaring* before averaging:

$$\sigma^2 \equiv \langle (\Delta j)^2 \rangle. \quad [1.11]$$

This quantity is known as the **variance** of the distribution; σ itself (the square root of the average of the square of the deviation from the average—gulp!) is called the **standard deviation**. The latter is the customary measure of the spread about $\langle j \rangle$.

There is a useful little theorem involving standard deviations:

$$\begin{aligned} \sigma^2 &= \langle (\Delta j)^2 \rangle = \sum (\Delta j)^2 P(j) = \sum (j - \langle j \rangle)^2 P(j) \\ &= \sum (j^2 - 2j\langle j \rangle + \langle j \rangle^2) P(j) \\ &= \sum j^2 P(j) - 2\langle j \rangle \sum j P(j) + \langle j \rangle^2 \sum P(j) \\ &= \langle j^2 \rangle - 2\langle j \rangle \langle j \rangle + \langle j \rangle^2, \end{aligned}$$

or

$$\sigma^2 = \langle j^2 \rangle - \langle j \rangle^2. \quad [1.12]$$

Equation 1.12 provides a faster method for computing σ : Simply calculate $\langle j^2 \rangle$ and $\langle j \rangle^2$, and subtract. Incidentally, I warned you a moment ago that $\langle j^2 \rangle$ is not, in general,

equal to $\langle j \rangle^2$. Since σ^2 is plainly nonnegative (from its definition in Equation 1.11), Equation 1.12 implies that

$$\langle j^2 \rangle \geq \langle j \rangle^2, \quad [1.13]$$

and the two are equal only when $\sigma = 0$, which is to say, for distributions with no spread at all (every member having the same value).

So far, I have assumed that we are dealing with a *discrete* variable—that is, one that can take on only certain isolated values (in the example, j had to be an integer, since I gave ages only in years). But it is simple enough to generalize to *continuous* distributions. If I select a random person off the street, the probability that her age is *precisely* 16 years, 4 hours, 27 minutes, and 3.3333 seconds is *zero*. The only sensible thing to speak about is the probability that her age lies in some *interval*—say, between 16 years, and 16 years plus one day. If the interval is sufficiently short, this probability is proportional to the length of the interval. For example, the chance that her age is between 16 and 16 plus *two* days is presumably twice the probability that it is between 16 and 16 plus *one* day. (Unless, I suppose, there was some extraordinary baby boom 16 years ago, on exactly those days—in which case we have chosen an interval too long for the rule to apply. If the baby boom lasted six hours, we’ll take intervals of a second or less, to be on the safe side. Technically, we’re talking about infinitesimal intervals.) Thus

$$\left\{ \begin{array}{l} \text{probability that individual (chosen at random)} \\ \text{lies between } x \text{ and } (x + dx) \end{array} \right\} = \rho(x) dx. \quad [1.14]$$

The proportionality factor, $\rho(x)$, is often loosely called “the probability of getting x ,” but this is sloppy language; a better term is **probability density**. The probability that x lies between a and b (a *finite* interval) is given by the integral of $\rho(x)$:

$$P_{ab} = \int_a^b \rho(x) dx, \quad [1.15]$$

and the rules we deduced for discrete distributions translate in the obvious way:

$$\int_{-\infty}^{+\infty} \rho(x) dx = 1, \quad [1.16]$$

$$\langle x \rangle = \int_{-\infty}^{+\infty} x \rho(x) dx, \quad [1.17]$$

$$\langle f(x) \rangle = \int_{-\infty}^{+\infty} f(x) \rho(x) dx, \quad [1.18]$$

$$\sigma^2 \equiv \langle (\Delta x)^2 \rangle = \langle x^2 \rangle - \langle x \rangle^2. \quad [1.19]$$

***Problem 1.1** For the distribution of ages in the example in Section 1.3,

- (a) Compute $\langle j^2 \rangle$ and $\langle j \rangle^2$.
- (b) Determine Δj for each j , and use Equation 1.11 to compute the standard deviation.
- (c) Use your results in (a) and (b) to check Equation 1.12.

Problem 1.2 Consider the first 25 digits in the decimal expansion of π (3, 1, 4, 1, 5, 9, ...).

- (a) If you selected one number at random from this set, what are the probabilities of getting each of the 10 digits?
- (b) What is the most probable digit? What is the median digit? What is the average value?
- (c) Find the standard deviation for this distribution.

Problem 1.3 The needle on a broken car speedometer is free to swing, and bounces perfectly off the pins at either end, so that if you give it a flick it is equally likely to come to rest at any angle between 0 and π .

- (a) What is the probability density, $\rho(\theta)$? [$\rho(\theta) d\theta$ is the probability that the needle will come to rest between θ and $(\theta + d\theta)$.] Graph $\rho(\theta)$ as a function of θ , from $-\pi/2$ to $3\pi/2$. (Of course, part of this interval is excluded, so ρ is zero there.) Make sure that the total probability is 1.
- (b) Compute $\langle \theta \rangle$, $\langle \theta^2 \rangle$, and σ for this distribution.
- (c) Compute $\langle \sin \theta \rangle$, $\langle \cos \theta \rangle$, and $\langle \cos^2 \theta \rangle$.

Problem 1.4 We consider the same device as the previous problem, but this time we are interested in the x -coordinate of the needle point—that is, the “shadow”, or “projection”, of the needle on the horizontal line.

- (a) What is the probability density $\rho(x)$? [$\rho(x) dx$ is the probability that the projection lies between x and $(x + dx)$.] Graph $\rho(x)$ as a function of x , from $-2r$ to $+2r$, where r is the length of the needle. Make sure the total probability is 1. [Hint: You know (from Problem 1.3) the probability that θ is in a given range; the question is, what interval dx corresponds to the interval $d\theta$?]
 - (b) Compute $\langle x \rangle$, $\langle x^2 \rangle$, and σ for this distribution. Explain how you could have obtained these results from part (c) of Problem 1.3.
-

****Problem 1.5** A needle of length l is dropped at random onto a sheet of paper ruled with parallel lines a distance l apart. What is the probability that the needle will cross a line? [*Hint*: Refer to Problem 1.4.]

***Problem 1.6** Consider the **Gaussian** distribution

$$\rho(x) = Ae^{-\lambda(x-a)^2},$$

where A , a , and λ are constants. (Look up any integrals you need.)

- (a) Use Equation 1.16 to determine A .
 - (b) Find $\langle x \rangle$, $\langle x^2 \rangle$, and σ .
 - (c) Sketch the graph of $\rho(x)$.
-

1.4 NORMALIZATION

We return now to the statistical interpretation of the wave function (Equation 1.3), which says that $|\Psi(x, t)|^2$ is the probability density for finding the particle at point x , at time t . It follows (Equation 1.16) that the integral of $|\Psi|^2$ must be 1 (the particle's got to be *somewhere*):

$$\int_{-\infty}^{+\infty} |\Psi(x, t)|^2 dx = 1. \quad [1.20]$$

Without this, the statistical interpretation would be nonsense.

However, this requirement should disturb you: After all, the wave function is supposed to be determined by the Schrödinger equation—we can't impose an extraneous condition on Ψ without checking that the two are consistent. A glance at Equation 1.1 reveals that if $\Psi(x, t)$ is a solution, so too is $A\Psi(x, t)$, where A is any (complex) constant. What we must do, then, is pick this undetermined multiplicative factor so as to ensure that Equation 1.20 is satisfied. This process is called **normalizing** the wave function. For some solutions to the Schrödinger equation, the integral is *infinite*; in that case *no* multiplicative factor is going to make it 1. The same goes for the trivial solution $\Psi = 0$. Such **non-normalizable** solutions cannot represent particles, and must be rejected. Physically realizable states correspond to the “square-integrable” solutions to Schrödinger's equation.⁸

⁸Evidently $\Psi(x, t)$ must go to zero faster than $1/\sqrt{|x|}$, as $|x| \rightarrow \infty$. Incidentally, normalization only fixes the *modulus* of A ; the *phase* remains undetermined. However, as we shall see, the latter carries no physical significance anyway.

But wait a minute! Suppose I have normalized the wave function at time $t = 0$. How do I know that it will *stay* normalized, as time goes on and Ψ evolves? (You can't keep *renormalizing* the wave function, for then A becomes a function of t , and you no longer have a solution to the Schrödinger equation.) Fortunately, the Schrödinger equation has the property that it automatically preserves the normalization of the wave function—without this crucial feature the Schrödinger equation would be incompatible with the statistical interpretation, and the whole theory would crumble. So we'd better pause for a careful proof of this point:

$$\frac{d}{dt} \int_{-\infty}^{+\infty} |\Psi(x, t)|^2 dx = \int_{-\infty}^{+\infty} \frac{\partial}{\partial t} |\Psi(x, t)|^2 dx. \quad [1.21]$$

[Note that the integral is a function only of t , so I use a total derivative (d/dt) in the first term, but the integrand is a function of x as well as t , so it's a partial derivative ($\partial/\partial t$) in the second one.] By the product rule,

$$\frac{\partial}{\partial t} |\Psi|^2 = \frac{\partial}{\partial t} (\Psi^* \Psi) = \Psi^* \frac{\partial \Psi}{\partial t} + \frac{\partial \Psi^*}{\partial t} \Psi \quad [1.22]$$

Now the Schrödinger equation says that

$$\frac{\partial \Psi}{\partial t} = \frac{i\hbar}{2m} \frac{\partial^2 \Psi}{\partial x^2} - \frac{i}{\hbar} V \Psi, \quad [1.23]$$

and hence also (taking the complex conjugate of Equation 1.23)

$$\frac{\partial \Psi^*}{\partial t} = -\frac{i\hbar}{2m} \frac{\partial^2 \Psi^*}{\partial x^2} + \frac{i}{\hbar} V \Psi^*, \quad [1.24]$$

so

$$\frac{\partial}{\partial t} |\Psi|^2 = \frac{i\hbar}{2m} \left(\Psi^* \frac{\partial^2 \Psi}{\partial x^2} - \frac{\partial^2 \Psi^*}{\partial x^2} \Psi \right) = \frac{\partial}{\partial x} \left[\frac{i\hbar}{2m} \left(\Psi^* \frac{\partial \Psi}{\partial x} - \frac{\partial \Psi^*}{\partial x} \Psi \right) \right]. \quad [1.25]$$

The integral (Equation 1.21) can now be evaluated explicitly:

$$\frac{d}{dt} \int_{-\infty}^{+\infty} |\Psi(x, t)|^2 dx = \frac{i\hbar}{2m} \left(\Psi^* \frac{\partial \Psi}{\partial x} - \frac{\partial \Psi^*}{\partial x} \Psi \right) \Big|_{-\infty}^{+\infty}. \quad [1.26]$$

But $\Psi(x, t)$ must go to zero as x goes to (\pm) infinity—otherwise the wave function would not be normalizable. It follows that

$$\frac{d}{dt} \int_{-\infty}^{+\infty} |\Psi(x, t)|^2 dx = 0, \quad [1.27]$$

and hence that the integral on the left is *constant* (independent of time); if Ψ is normalized at $t = 0$, it *stays* normalized for all future time. QED

Problem 1.7 At time $t = 0$ a particle is represented by the wave function

$$\Psi(x, 0) = \begin{cases} Ax/a, & \text{if } 0 \leq x \leq a, \\ A(b-x)/(b-a), & \text{if } a \leq x \leq b, \\ 0, & \text{otherwise,} \end{cases}$$

where A , a , and b are constants.

- (a) Normalize Ψ (that is, find A in terms of a and b).
- (b) Sketch $\Psi(x, 0)$ as a function of x .
- (c) Where is the particle most likely to be found, at $t = 0$?
- (d) What is the probability of finding the particle to the left of a ? Check your result in the limiting cases $b = a$ and $b = 2a$.
- (e) What is the expectation value of x ?

***Problem 1.8** Consider the wave function

$$\Psi(x, t) = Ae^{-\lambda|x|}e^{-i\omega t},$$

where A , λ , and ω are positive real constants. [We'll see in Chapter 2 what potential (V) actually produces such a wave function.]

- (a) Normalize Ψ .
- (b) Determine the expectation values of x and x^2 .
- (c) Find the standard deviation of x . Sketch the graph of $|\Psi|^2$, as a function of x , and mark the points $(\langle x \rangle + \sigma)$ and $(\langle x \rangle - \sigma)$ to illustrate the sense in which σ represents the "spread" in x . What is the probability that the particle would be found outside this range?

Problem 1.9 Let $P_{ab}(t)$ be the probability of finding the particle in the range ($a < x < b$), at time t .

- (a) Show that

$$\frac{dP_{ab}}{dt} = J(a, t) - J(b, t)$$

where

$$J(x, t) \equiv \frac{i\hbar}{2m} \left(\Psi \frac{\partial \Psi^*}{\partial x} - \Psi^* \frac{\partial \Psi}{\partial x} \right).$$

What are the units of $J(x, t)$? [J is called the **probability current**, because it tells you the rate at which probability is "flowing" past the point x . If $P_{ab}(t)$ is increasing, then more probability is flowing into the region at one end than flows out at the other.]

- (b) Find the probability current for the wave function in the previous problem. (This is not a very pithy example, I'm afraid; we'll encounter some more substantial ones in due course.)

****Problem 1.10** Suppose you wanted to describe an **unstable particle** that spontaneously disintegrates with a "lifetime" τ . In that case the total probability of finding the particle somewhere should *not* be constant, but should decrease at (say) an exponential rate:

$$P(t) \equiv \int_{-\infty}^{+\infty} |\Psi(x, t)|^2 dx = e^{-t/\tau}.$$

A crude way of achieving this result is as follows. In Equation 1.24 we tacitly assumed that V (the potential energy) is *real*. That is certainly reasonable, but it leads to the **conservation of probability** enshrined in Equation 1.27. What if we assign to V an imaginary part:

$$V = V_0 - i\Gamma,$$

where V_0 is the true potential energy and Γ is a positive real constant?

- (a) Show that (in place of Equation 1.27) we now get

$$\frac{dP}{dt} = -\frac{2\Gamma}{\hbar}P.$$

- (b) Solve for $P(t)$, and find the lifetime of the particle in terms of Γ .
-

1.5 MOMENTUM

For a particle in state Ψ , the expectation value of x is

$$\langle x \rangle = \int_{-\infty}^{+\infty} x |\Psi(x, t)|^2 dx. \quad [1.28]$$

What exactly does this mean? It emphatically does *not* mean that if you measure the position of one particle over and over again, $\int x |\Psi|^2 dx$ is the average of the results you'll get. On the contrary, **the first measurement (whose outcome is indeterminate) will collapse the wave function to a spike at the value actually obtained**, and the subsequent measurements (if they're performed quickly) will simply repeat that same result. Rather, $\langle x \rangle$ is the average of measurements performed on particles *all in the state* Ψ , which means that either you must find some way of returning the particle to its original state after each measurement, or else you prepare a whole ensemble of particles, each in the same state Ψ , and measure the positions of all of them: $\langle x \rangle$ is the

average of *these* results. [I like to picture a row of bottles on a shelf, each containing a particle in the state Ψ (relative to the center of the bottle). A graduate student with a ruler is assigned to each bottle, and at a signal they all measure the positions of their respective particles. We then construct a histogram of the results, which should match $|\Psi|^2$, and compute the average, which should agree with $\langle x \rangle$. (Of course, since we're only using a finite sample, we can't expect perfect agreement, but the more bottles we use, the closer we ought to come.)] In short, **the expectation value is the average of repeated measurements on an ensemble of identically prepared systems, not the average of repeated measurements on one and the same system.**

Now, as time goes on, $\langle x \rangle$ will change (because of the time dependence of Ψ), and we might be interested in knowing how fast it moves. Referring to Equations 1.25 and 1.28, we see that⁹

$$\frac{d\langle x \rangle}{dt} = \int x \frac{\partial}{\partial t} |\Psi|^2 dx = \frac{i\hbar}{2m} \int x \frac{\partial}{\partial x} \left(\Psi^* \frac{\partial \Psi}{\partial x} - \frac{\partial \Psi^*}{\partial x} \Psi \right) dx. \quad [1.29]$$

This expression can be simplified using integration by parts¹⁰:

$$\frac{d\langle x \rangle}{dt} = -\frac{i\hbar}{2m} \int \left(\Psi^* \frac{\partial \Psi}{\partial x} - \frac{\partial \Psi^*}{\partial x} \Psi \right) dx. \quad [1.30]$$

[I used the fact that $\partial x / \partial x = 1$, and threw away the boundary term, on the ground that Ψ goes to zero at (\pm) infinity.] Performing another integration by parts on the second term, we conclude that

$$\frac{d\langle x \rangle}{dt} = -\frac{i\hbar}{m} \int \Psi^* \frac{\partial \Psi}{\partial x} dx. \quad [1.31]$$

What are we to make of this result? Note that we're talking about the "velocity" of the *expectation* value of x , which is not the same thing as the velocity of the *particle*. Nothing we have seen so far would enable us to calculate the velocity of a particle—it's not even clear what velocity *means* in quantum mechanics. If the particle doesn't have a determinate position (prior to measurement), neither does it have a well-defined velocity. All we could reasonably ask for is the *probability* of getting a particular value. We'll see in Chapter 3 how to construct the probability density for velocity,

⁹To keep things from getting too cluttered, I suppress the limits of integration when they are $\pm\infty$.

¹⁰The product rule says that

$$\frac{d}{dx}(fg) = f \frac{dg}{dx} + \frac{df}{dx} g,$$

from which it follows that

$$\int_a^b f \frac{dg}{dx} dx = - \int_a^b \frac{df}{dx} g dx + fg \Big|_a^b.$$

Under the integral sign, then, you can peel a derivative off one factor in a product and slap it onto the other one—it'll cost you a minus sign, and you'll pick up a boundary term.

given Ψ ; for our present purposes it will suffice to postulate that the *expectation value of the velocity is equal to the time derivative of the expectation value of position*:

$$\langle v \rangle = \frac{d\langle x \rangle}{dt}. \quad [1.32]$$

Equation 1.31 tells us, then, how to calculate $\langle v \rangle$ directly from Ψ .

Actually, it is customary to work with momentum ($p = mv$), rather than velocity:

$$\langle p \rangle = m \frac{d\langle x \rangle}{dt} = -i\hbar \int \left(\Psi^* \frac{\partial \Psi}{\partial x} \right) dx. \quad [1.33]$$

Let me write the expressions for $\langle x \rangle$ and $\langle p \rangle$ in a more suggestive way:

$$\langle x \rangle = \int \Psi^*(x) \Psi dx, \quad [1.34]$$

$$\langle p \rangle = \int \Psi^* \left(\frac{\hbar}{i} \frac{\partial}{\partial x} \right) \Psi dx. \quad [1.35]$$

We say that the **operator**¹¹ x “represents” position, and the operator $(\hbar/i)(\partial/\partial x)$ “represents” momentum, in quantum mechanics; to calculate expectation values, we “sandwich” the appropriate operator between Ψ^* and Ψ , and integrate.

That’s cute, but what about other dynamical variables? The fact is, *all* such quantities can be written in terms of position and momentum. Kinetic energy, for example, is

$$T = \frac{1}{2}mv^2 = \frac{p^2}{2m},$$

and angular momentum is

$$\mathbf{L} = \mathbf{r} \times m\mathbf{v} = \mathbf{r} \times \mathbf{p}$$

(the latter, of course, does not occur for motion in one dimension). To calculate the expectation value of such a quantity, we simply replace every p by $(\hbar/i)(\partial/\partial x)$, insert the resulting operator between Ψ^* and Ψ , and integrate:

$$\langle Q(x, p) \rangle = \int \Psi^* Q(x, \frac{\hbar}{i} \frac{\partial}{\partial x}) \Psi dx. \quad [1.36]$$

¹¹An operator is an instruction to *do something* to the function that follows. The position operator tells you to *multiply* by x ; the momentum operator tells you to *differentiate* with respect to x (and multiply the result by $-i\hbar$). In this book *all* operators will be derivatives (d/dt , d^2/dt^2 , $\partial^2/\partial x \partial y$, etc.) or multipliers (2 , i , x^2 , etc.) or combinations of these.

For example,

$$\langle T \rangle = \frac{-\hbar^2}{2m} \int \Psi^* \frac{\partial^2 \Psi}{\partial x^2} dx. \quad [1.37]$$

Equation 1.36 is a recipe for computing the expectation value of any dynamical quantity for a particle in state Ψ ; it subsumes Equations 1.34 and 1.35 as special cases. I have tried in this section to make Equation 1.36 seem plausible, given Born's statistical interpretation, but the truth is that this equation represents such a radically new way of doing business (as compared with classical mechanics) that it's a good idea to get some practice using it before we come back (in Chapter 3) and put it on a firmer theoretical foundation. In the meantime, if you prefer to think of it as an *axiom*, that's fine with me.

Problem 1.11 Why can't you do integration by parts directly on the middle expression in Equation 1.29—pull the time derivative over onto x , note that $\partial x / \partial t = 0$, and conclude that $d\langle x \rangle / dt = 0$?

***Problem 1.12** Calculate $d\langle p \rangle / dt$. Answer:

$$\frac{d\langle p \rangle}{dt} = \left\langle -\frac{\partial V}{\partial x} \right\rangle. \quad [1.38]$$

(This is known as **Ehrenfest's theorem**; it tells us that *expectation values* obey Newton's second law.)

Problem 1.13 Suppose you add a constant V_0 to the potential energy (by "constant" I mean independent of x as well as t). In *classical* mechanics this doesn't change anything, but what about *quantum* mechanics? Show that the wave function picks up a time-dependent phase factor: $\exp(-iV_0t/\hbar)$. What effect does this have on the expectation value of a dynamical variable?

1.6 THE UNCERTAINTY PRINCIPLE

Imagine that you're holding one end of a very long rope, and you generate a wave by shaking it up and down rhythmically (Figure 1.6). If someone asked you, "Precisely where is that wave?" you'd probably think he was a little bit nutty: The wave isn't precisely *anywhere*—it's spread out over 50 feet or so. On the other hand, if he asked you what its *wavelength* is, you could give him a reasonable answer: It looks like about 6 feet. By contrast, if you gave the rope a sudden jerk (Figure 1.7), you'd get a relatively narrow bump traveling down the line. This time the first question (Where precisely is the wave?) is a sensible one, and the second (What is its wavelength?) seems nutty—it isn't even vaguely periodic, so how can you assign a wavelength to it?

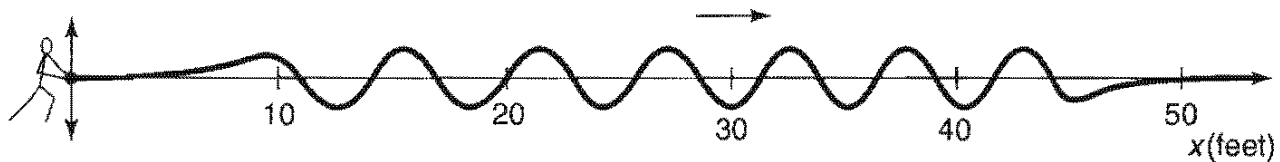

Figure 1.6: A wave with a (fairly) well-defined wavelength but an ill-defined position.

Of course, you can draw intermediate cases, in which the wave is *fairly* well localized and the wavelength is *fairly* well defined, but there is an inescapable trade-off here: The more precise a wave's position is, the less precise is its wavelength, and vice versa.¹² A theorem in Fourier analysis makes all this rigorous, but for the moment I am only concerned with the qualitative argument.

This applies, of course, to *any* wave phenomenon, and hence in particular to the quantum mechanical wave function. Now the wavelength of Ψ is related to the *momentum* of the particle by the **de Broglie formula**¹³:

$$p = \frac{h}{\lambda} = \frac{2\pi\hbar}{\lambda}. \quad [1.39]$$

Thus a spread in *wavelength* corresponds to a spread in *momentum*, and our general observation now says that the more precisely determined a particle's position is, the less precisely its momentum is determined. Quantitatively,

$$\sigma_x \sigma_p \geq \frac{\hbar}{2}, \quad [1.40]$$

where σ_x is the standard deviation in x , and σ_p is the standard deviation in p . This is Heisenberg's famous **uncertainty principle**. (We'll prove it in Chapter 3, but I wanted to mention it here so you can test it out on the examples in Chapter 2.)

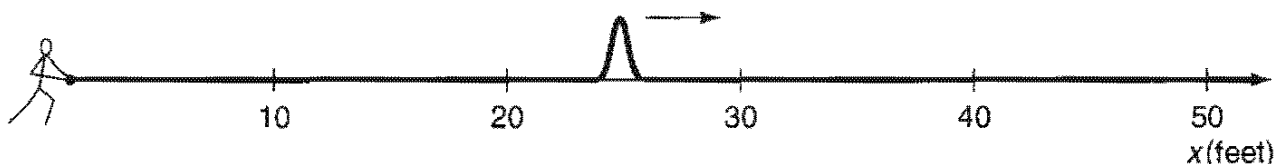

Figure 1.7: A wave with a (fairly) well-defined position but an ill-defined wavelength.

¹²That's why a piccolo player must be right on pitch, whereas a double-bass player can afford to wear garden gloves. For the piccolo, a sixty-fourth note contains many full cycles, and the frequency (we're working in the time domain now, instead of space) is well defined, whereas for the bass, at a much lower register, the sixty-fourth note contains only a few cycles, and all you hear is a general sort of "oomph," with no very clear pitch.

¹³I'll prove this in due course. Many authors take the de Broglie formula as an *axiom*, from which they then deduce the association of momentum with the operator $(\hbar/i)(\partial/\partial x)$. Although this is a conceptually cleaner approach, it involves diverting mathematical complications that I would rather save for later.

Please understand what the uncertainty principle *means*: Like position measurements, momentum measurements yield precise answers—the “spread” here refers to the fact that measurements on identical systems do not yield consistent results. You can, if you want, prepare a system such that repeated position measurements will be very close together (by making Ψ a localized “spike”), but you will pay a price: Momentum measurements on this state will be widely scattered. Or you can prepare a system with a reproducible momentum (by making Ψ a long sinusoidal wave), but in that case position measurements will be widely scattered. And, of course, if you’re in a really bad mood you can prepare a system in which neither position nor momentum is well defined: Equation 1.40 is an inequality, and there’s no limit on how *big* σ_x and σ_p can be—just make Ψ some long wiggly line with lots of bumps and potholes and no periodic structure.

***Problem 1.14** A particle of mass m is in the state

$$\Psi(x, t) = Ae^{-a[(mx^2/\hbar)+it]},$$

where A and a are positive real constants.

- (a) Find A .
 - (b) For what potential energy function $V(x)$ does Ψ satisfy the Schrödinger equation?
 - (c) Calculate the expectation values of x , x^2 , p , and p^2 .
 - (d) Find σ_x and σ_p . Is their product consistent with the uncertainty principle?
-

CHAPTER 2

THE TIME-INDEPENDENT SCHRÖDINGER EQUATION

2.1 STATIONARY STATES

In Chapter 1 we talked a lot about the wave function and how you use it to calculate various quantities of interest. The time has come to stop procrastinating and confront what is, logically, the prior question: How do you *get* $\Psi(x, t)$ in the first place—how do you go about solving the Schrödinger equation? I shall assume for all of this chapter (and most of this book) that the potential,¹ V , is *independent of t* . In that case the Schrödinger equation can be solved by the method of **separation of variables** (the physicist’s first line of attack on any partial differential equation): We look for solutions that are simple *products*,

$$\Psi(x, t) = \psi(x) f(t), \quad [2.1]$$

where ψ (*lowercase*) is a function of x alone, and f is a function of t alone. On its face, this is an absurd restriction, and we cannot hope to get more than a tiny subset of all solutions in this way. But hang on, because the solutions we *do* obtain turn out to be of great interest. Moreover, as is typically the case with separation of variables, we will be able at the end to patch together the separable solutions in such a way as to construct the most general solution.

¹It is tiresome to keep saying “potential energy function,” so most people just call V the “potential”, even though this invites occasional confusion with *electric* potential, which is actually potential energy *per unit charge*.

For separable solutions we have

$$\frac{\partial \Psi}{\partial t} = \psi \frac{df}{dt}, \quad \frac{\partial^2 \Psi}{\partial x^2} = \frac{d^2 \psi}{dx^2} f$$

(ordinary derivatives, now), and the Schrödinger equation (Equation 1.1) reads

$$i\hbar \psi \frac{df}{dt} = -\frac{\hbar^2}{2m} \frac{d^2 \psi}{dx^2} f + V \psi f.$$

Or, dividing through by ψf :

$$i\hbar \frac{1}{f} \frac{df}{dt} = -\frac{\hbar^2}{2m} \frac{1}{\psi} \frac{d^2 \psi}{dx^2} + V. \quad [2.2]$$

Now the left side is a function of t alone, and the right side is a function of x alone.² The only way this can possibly be true is if both sides are in fact *constant*—otherwise, by varying t , I could change the left side without touching the right side, and the two would no longer be equal. (That's a subtle but crucial argument, so if it's new to you, be sure to pause and think it through.) For reasons that will appear in a moment, we shall call the separation constant E . Then

$$i\hbar \frac{1}{f} \frac{df}{dt} = E,$$

or

$$\frac{df}{dt} = -\frac{iE}{\hbar} f, \quad [2.3]$$

and

$$-\frac{\hbar^2}{2m} \frac{1}{\psi} \frac{d^2 \psi}{dx^2} + V = E,$$

or

$$\boxed{-\frac{\hbar^2}{2m} \frac{d^2 \psi}{dx^2} + V \psi = E \psi.} \quad [2.4]$$

Separation of variables has turned a *partial* differential equation into two *ordinary* differential equations (Equations 2.3 and 2.4). The first of these is easy to solve (just multiply through by dt and integrate); the general solution is $C \exp(-iEt/\hbar)$, but we might as well absorb the constant C into ψ (since the quantity of interest is the product ψf). Then

$$f(t) = e^{-iEt/\hbar}. \quad [2.5]$$

The second (Equation 2.4) is called the **time-independent Schrödinger equation**; we can go no further with it until the potential $V(x)$ is specified.

²Note that this would *not* be true if V were a function of t as well as x .

The rest of this chapter will be devoted to solving the time-independent Schrödinger equation, for a variety of simple potentials. But before we get to that I would like to consider further the question: *What's so great about separable solutions?* After all, *most* solutions to the (time-dependent) Schrödinger equation do *not* take the form $\psi(x)f(t)$. I offer three answers—two of them physical and one mathematical:

1. They are **stationary states**. Although the wave function itself,

$$\Psi(x, t) = \psi(x)e^{-iEt/\hbar}, \quad [2.6]$$

does (obviously) depend on t , the probability density

$$|\Psi(x, t)|^2 = \Psi^*\Psi = \psi^*e^{+iEt/\hbar}\psi e^{-iEt/\hbar} = |\psi(x)|^2 \quad [2.7]$$

does *not*—the time dependence cancels out.³ The same thing happens in calculating the expectation value of any dynamical variable; Equation 1.36 reduces to

$$\langle Q(x, p) \rangle = \int \psi^* Q(x, \frac{\hbar}{i} \frac{d}{dx}) \psi dx. \quad [2.8]$$

Every expectation value is constant in time; we might as well drop the factor $f(t)$ altogether, and simply use ψ in place of Ψ . (Indeed, it is common to refer to ψ as “the wave function”, but this is sloppy language that can be dangerous, and it is important to remember that the *true* wave function always carries that exponential time-dependent factor.) In particular, $\langle x \rangle$ is constant, and hence (Equation 1.33) $\langle p \rangle = 0$. Nothing ever *happens* in a stationary state.

2. They are states of *definite total energy*. In classical mechanics, the total energy (kinetic plus potential) is called the **Hamiltonian**:

$$H(x, p) = \frac{p^2}{2m} + V(x). \quad [2.9]$$

The corresponding Hamiltonian *operator*, obtained by the canonical substitution $p \rightarrow (\hbar/i)(\partial/\partial x)$, is therefore⁴

$$\hat{H} = -\frac{\hbar^2}{2m} \frac{\partial^2}{\partial x^2} + V(x). \quad [2.10]$$

Thus the time-independent Schrödinger equation (Equation 2.4) can be written

$$\hat{H}\psi = E\psi, \quad [2.11]$$

³For normalizable solutions, E must be real (see Problem 2.1a).

⁴Whenever confusion might arise, I'll put a “hat” ($\hat{\ })$ on the operator to distinguish it from the dynamical variable it represents.

and the expectation value of the total energy is

$$\langle H \rangle = \int \psi^* \hat{H} \psi dx = E \int |\psi|^2 dx = E. \quad [2.12]$$

(Note that the normalization of Ψ entails the normalization of ψ .) Moreover,

$$\hat{H}^2 \psi = \hat{H}(\hat{H} \psi) = \hat{H}(E \psi) = E(\hat{H} \psi) = E^2 \psi,$$

and hence

$$\langle H^2 \rangle = \int \psi^* \hat{H}^2 \psi dx = E^2 \int |\psi|^2 dx = E^2.$$

So the standard deviation in H is given by

$$\sigma_H^2 = \langle H^2 \rangle - \langle H \rangle^2 = E^2 - E^2 = 0. \quad [2.13]$$

But remember, if $\sigma = 0$, then every member of the sample must share the same value (the distribution has zero spread). Conclusion: A separable solution has the property that *every measurement of the total energy is certain to return the value E* . (That's why I chose that letter for the separation constant.)

3. The general solution is a **linear combination** of separable solutions. As we're about to discover, the time-independent Schrödinger equation (Equation 2.4) yields an infinite collection of solutions ($\psi_1(x)$, $\psi_2(x)$, $\psi_3(x)$, ...), each with its associated value of the separation constant (E_1 , E_2 , E_3 , ...); thus there is a different wave function for each **allowed energy**:

$$\Psi_1(x, t) = \psi_1(x)e^{-iE_1t/\hbar}, \quad \Psi_2(x, t) = \psi_2(x)e^{-iE_2t/\hbar}, \dots$$

Now (as you can easily check for yourself) the (time-dependent) Schrödinger equation (Equation 1.1) has the property that any linear combination⁵ of solutions is itself a solution. Once we have found the separable solutions, then, we can immediately construct a much more general solution, of the form

$$\Psi(x, t) = \sum_{n=1}^{\infty} c_n \psi_n(x) e^{-iE_n t/\hbar}. \quad [2.14]$$

It so happens that *every* solution to the (time-dependent) Schrödinger equation can be written in this form—it is simply a matter of finding the right constants (c_1 , c_2 , ...) so as to fit the initial conditions for the problem at hand. You'll see in the following sections how all this works out in practice, and in Chapter 3 we'll put it into more elegant language, but the main point is this: Once you've solved the time-independent

⁵A linear combination of the functions $f_1(z)$, $f_2(z)$, ... is an expression of the form

$$f(z) = c_1 f_1(z) + c_2 f_2(z) + \dots,$$

where c_1 , c_2 , ... are any (complex) constants.

Schrödinger equation, you're essentially done; getting from there to the general solution of the time-*dependent* Schrödinger equation is simple and straightforward.

***Problem 2.1** Prove the following theorems:

- (a) For normalizable solutions, the separation constant E must be *real*. *Hint*: Write E (in Equation 2.6) as $E_0 + i\Gamma$ (with E_0 and Γ real), and show that if Equation 1.20 is to hold for all t , Γ must be zero.
- (b) ψ can always be taken to be *real* (unlike Ψ , which is necessarily complex). *Note*: This doesn't mean that every solution to the time-independent Schrödinger equation *is* real; what it says is that if you've got one that is *not*, it can always be expressed as a linear combination of solutions (with the same energy) that *are*. So in Equation 2.14 you *might as well* stick to ψ 's that are real. *Hint*: If $\psi(x)$ satisfies the time-independent Schrödinger equation for a given E , so too does its complex conjugate, and hence also the real linear combinations $(\psi + \psi^*)$ and $i(\psi - \psi^*)$.
- (c) If $V(x)$ is an *even* function [i.e., $V(-x) = V(x)$], then $\psi(x)$ can always be taken to be either even or odd. *Hint*: If $\psi(x)$ satisfies the time-independent Schrödinger equation for a given E , so too does $\psi(-x)$, and hence also the even and odd linear combinations $\psi(x) \pm \psi(-x)$.

***Problem 2.2** Show that E must exceed the minimum value of $V(x)$ for every normalizable solution to the time-independent Schrödinger equation. What is the classical analog to this statement? *Hint*: Rewrite Equation 2.4 in the form

$$\frac{d^2\psi}{dx^2} = \frac{2m}{\hbar^2}[V(x) - E]\psi;$$

if $E < V_{\min}$, then ψ and its second derivative always have the *same sign*—argue that such a function cannot be normalized.

2.2 THE INFINITE SQUARE WELL

Suppose

$$V(x) = \begin{cases} 0, & \text{if } 0 \leq x \leq a, \\ \infty, & \text{otherwise} \end{cases} \quad [2.15]$$

(Figure 2.1). A particle in this potential is completely free, except at the two ends ($x = 0$ and $x = a$), where an infinite force prevents it from escaping. A classical model would be a cart on a frictionless horizontal air track, with perfectly elastic bumpers—it just keeps bouncing back and forth forever. (This potential is awfully artificial, but I urge you to treat it with respect. Despite its simplicity—or rather,

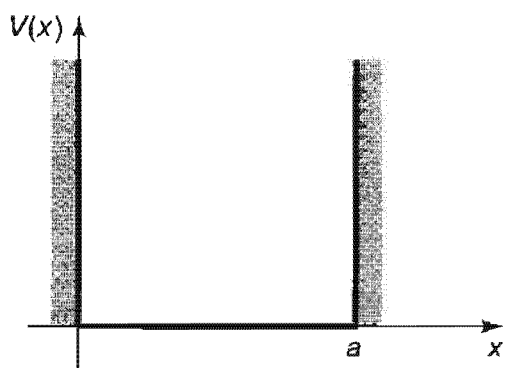

Figure 2.1: The infinite square well potential (Equation 2.15).

precisely *because* of its simplicity—it serves as a wonderfully accessible test case for all the fancy stuff that comes later. We’ll refer back to it frequently.)

Outside the well, $\psi(x) = 0$ (the probability of finding the particle there is zero). Inside the well, where $V = 0$, the time-independent Schrödinger equation (Equation 2.4) reads

$$-\frac{\hbar^2}{2m} \frac{d^2\psi}{dx^2} = E\psi, \quad [2.16]$$

or

$$\frac{d^2\psi}{dx^2} = -k^2\psi, \quad \text{where } k \equiv \frac{\sqrt{2mE}}{\hbar}. \quad [2.17]$$

(By writing it in this way, I have tacitly assumed that $E \geq 0$; we know from Problem 2.2 that $E < 0$ doesn’t work.) Equation 2.17 is the (classical) **simple harmonic oscillator** equation; the general solution is

$$\psi(x) = A \sin kx + B \cos kx, \quad [2.18]$$

where A and B are arbitrary constants. Typically, these constants are fixed by the **boundary conditions** of the problem. What are the appropriate boundary conditions for $\psi(x)$? Ordinarily, both ψ and $d\psi/dx$ are continuous, but where the potential goes to infinity only the first of these applies. (I’ll *prove* these boundary conditions, and account for the exception when $V = \infty$, later on; for now I hope you will trust me.)

Continuity of $\psi(x)$ requires that

$$\psi(0) = \psi(a) = 0, \quad [2.19]$$

so as to join onto the solution outside the well. What does this tell us about A and B ? Well,

$$\psi(0) = A \sin 0 + B \cos 0 = B,$$

so $B = 0$, and hence

$$\psi(x) = A \sin kx. \quad [2.20]$$

Then $\psi(a) = A \sin ka$, so either $A = 0$ [in which case we’re left with the trivial—nonnormalizable—solution $\psi(x) = 0$], or else $\sin ka = 0$, which means that

$$ka = 0, \pm\pi, \pm2\pi, \pm3\pi, \dots \quad [2.21]$$

But $k = 0$ is no good [again, that would imply $\psi(x) = 0$], and the negative solutions give nothing new, since $\sin(-\theta) = -\sin(\theta)$ and we can absorb the minus sign into A . So the *distinct* solutions are

$$k_n = \frac{n\pi}{a}, \quad \text{with } n = 1, 2, 3, \dots \quad [2.22]$$

Curiously, the boundary condition at $x = a$ does not determine the constant A , but rather the constant k , and hence the possible values of E :

$$E_n = \frac{\hbar^2 k_n^2}{2m} = \frac{n^2 \pi^2 \hbar^2}{2ma^2}. \quad [2.23]$$

In sharp contrast to the classical case, a quantum particle in the infinite square well cannot have just *any* old energy—only these special **allowed** values. Well, how *do* we fix the constant A ? Answer: We *normalize* ψ :

$$\int_0^a |A|^2 \sin^2(kx) dx = |A|^2 \frac{a}{2} = 1, \quad \text{so } |A|^2 = \frac{2}{a}.$$

This only determines the *magnitude* of A , but it is simplest to pick the positive real root: $A = \sqrt{2/a}$ (the phase of A carries no physical significance anyway). Inside the well, then, the solutions are

$$\psi_n(x) = \sqrt{\frac{2}{a}} \sin\left(\frac{n\pi}{a}x\right). \quad [2.24]$$

As promised, the time-independent Schrödinger equation has delivered an infinite set of solutions, one for each integer n . The first few of these are plotted in Figure 2.2; they look just like the standing waves on a string of length a . ψ_1 , which carries the lowest energy, is called the **ground state**; the others, whose energies increase in proportion to n^2 , are called **excited states**. As a group, the functions $\psi_n(x)$ have some interesting and important properties:

1. They are alternately **even** and **odd**, with respect to the center of the well. (ψ_1 is even, ψ_2 is odd, ψ_3 is even, and so on.⁶)

2. As you go up in energy, each successive state has one more **node** (zero crossing). ψ_1 has none (the end points don't count), ψ_2 has one, ψ_3 has two, and so on.

⁶To make this symmetry more apparent, some authors center the well at the origin (so that it runs from $-a/2$ to $+a/2$). The even functions are then cosines, and the odd ones are sines. See Problem 2.4.

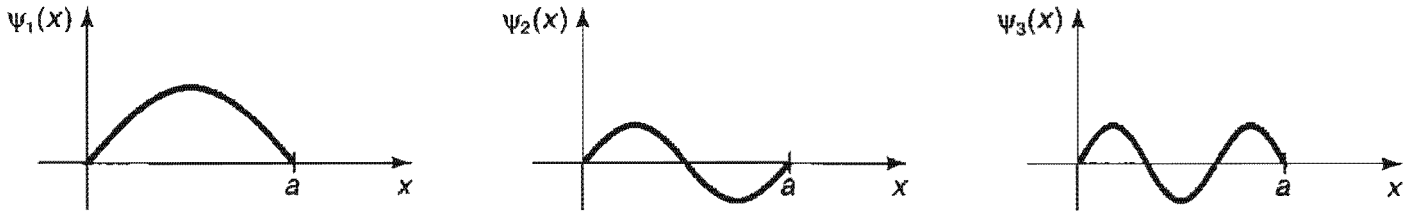

Figure 2.2: The first three stationary states of the infinite square well (Equation 2.24).

3. They are mutually **orthogonal**, in the sense that

$$\int \psi_m(x)^* \psi_n(x) dx = 0, \quad [2.25]$$

whenever $m \neq n$. Proof

$$\begin{aligned} \int \psi_m(x)^* \psi_n(x) dx &= \frac{2}{a} \int_0^a \sin\left(\frac{m\pi}{a}x\right) \sin\left(\frac{n\pi}{a}x\right) dx \\ &= \frac{1}{a} \int_0^a \left[\cos\left(\frac{m-n}{a}\pi x\right) - \cos\left(\frac{m+n}{a}\pi x\right) \right] dx \\ &= \left\{ \frac{1}{(m-n)\pi} \sin\left(\frac{m-n}{a}\pi x\right) - \frac{1}{(m+n)\pi} \sin\left(\frac{m+n}{a}\pi x\right) \right\} \Big|_0^a \\ &= \frac{1}{\pi} \left\{ \frac{\sin[(m-n)\pi]}{(m-n)} - \frac{\sin[(m+n)\pi]}{(m+n)} \right\} = 0. \end{aligned}$$

Note that this argument does *not* work if $m = n$ (can you spot the point at which it fails?); in that case normalization tells us that the integral is 1. In fact, we can combine orthogonality and normalization into a single statement⁷:

$$\int \psi_m(x)^* \psi_n(x) dx = \delta_{mn}, \quad [2.26]$$

where δ_{mn} (the so-called **Kronecker delta**) is defined in the usual way,

$$\delta_{mn} = \begin{cases} 0, & \text{if } m \neq n; \\ 1, & \text{if } m = n. \end{cases} \quad [2.27]$$

We say that the ψ 's are **orthonormal**.

4. They are **complete**, in the sense that any *other* function, $f(x)$, can be expressed as a linear combination of them:

$$f(x) = \sum_{n=1}^{\infty} c_n \psi_n(x) = \sqrt{\frac{2}{a}} \sum_{n=1}^{\infty} c_n \sin\left(\frac{n\pi}{a}x\right). \quad [2.28]$$

⁷In this case the ψ 's are real, so the $*$ on ψ_m is unnecessary, but for future purposes it's a good idea to get in the habit of putting it there.

I'm not about to *prove* the completeness of the functions $\sqrt{2/a} \sin(n\pi x/a)$, but if you've studied advanced calculus you will recognize that Equation 2.28 is nothing but the **Fourier series** for $f(x)$, and the fact that "any" function can be expanded in this way is sometimes called **Dirichlet's theorem**.⁸ The expansion coefficients (c_n) can be evaluated—for a given $f(x)$ —by a method I call **Fourier's trick**, which beautifully exploits the orthonormality of $\{\psi_n\}$: Multiply both sides of Equation 2.28 by $\psi_m(x)^*$, and integrate.

$$\int \psi_m(x)^* f(x) dx = \sum_{n=1}^{\infty} c_n \int \psi_m(x)^* \psi_n(x) dx = \sum_{n=1}^{\infty} c_n \delta_{mn} = c_m. \quad [2.29]$$

(Notice how the Kronecker delta kills every term in the sum except the one for which $n = m$.) Thus the m th coefficient in the expansion of $f(x)$ is given by

$$c_m = \int \psi_m(x)^* f(x) dx. \quad [2.30]$$

These four properties are extremely powerful, and they are not peculiar to the infinite square well. The first is true whenever the potential itself is an even function; the second is universal, regardless of the shape of the potential.⁹ Orthogonality is also quite general—I'll show you the proof in Chapter 3. Completeness holds for all the potentials you are likely to encounter, but the proofs tend to be nasty and laborious; I'm afraid most physicists simply *assume* completeness and hope for the best.

The stationary states (Equation 2.6) for the infinite square well are evidently

$$\Psi_n(x, t) = \sqrt{\frac{2}{a}} \sin\left(\frac{n\pi}{a}x\right) e^{-i(n^2\pi^2\hbar/2ma^2)t}. \quad [2.31]$$

I claimed (Equation 2.14) that the most general solution to the (time-dependent) Schrödinger equation is a linear combination of stationary states:

$$\Psi(x, t) = \sum_{n=1}^{\infty} c_n \sqrt{\frac{2}{a}} \sin\left(\frac{n\pi}{a}x\right) e^{-i(n^2\pi^2\hbar/2ma^2)t}. \quad [2.32]$$

If you doubt that this *is* a solution, by all means *check* it! It remains only for me to demonstrate that I can fit any prescribed initial wave function, $\Psi(x, 0)$, by appropriate choice of the coefficients c_n . According to Equation 2.32,

$$\Psi(x, 0) = \sum_{n=1}^{\infty} c_n \psi_n(x).$$

⁸See, for example, Mary Boas, *Mathematical Methods in the Physical Sciences*, 2nd ed. (New York: John Wiley & Sons, 1983), p. 313; $f(x)$ can even have a finite number of finite discontinuities.

⁹See, for example, John L. Powell and Bernd Crasemann, *Quantum Mechanics* (Reading, MA: Addison-Wesley, 1961), p. 126.

The completeness of the ψ 's (confirmed in this case by Dirichlet's theorem) guarantees that I can always express $\Psi(x, 0)$ in this way, and their orthonormality licenses the use of Fourier's trick to determine the actual coefficients:

$$c_n = \sqrt{\frac{2}{a}} \int_0^a \sin\left(\frac{n\pi}{a}x\right) \Psi(x, 0) dx. \quad / \quad [2.33]$$

That does it: Given the initial wave function, $\Psi(x, 0)$, we first compute the expansion coefficients c_n , using Equation 2.33, and then plug these into Equation 2.32 to obtain $\Psi(x, t)$. Armed with the wave function, we are in a position to compute any dynamical quantities of interest, using the procedures in Chapter 1. And this same ritual applies to *any* potential—the only things that change are the functional form of the ψ 's and the equation for the allowed energies.

Problem 2.3 Show that there is no acceptable solution to the (time-independent) Schrödinger equation (for the infinite square well) with $E = 0$ or $E < 0$. (This is a special case of the general theorem in Problem 2.2, but this time do it by explicitly solving the Schrödinger equation and showing that you cannot meet the boundary conditions.)

Problem 2.4 Solve the time-independent Schrödinger equation with appropriate boundary conditions for an infinite square well centered at the origin [$V(x) = 0$, for $-a/2 < x < +a/2$; $V(x) = \infty$ otherwise]. Check that your allowed energies are consistent with mine (Equation 2.23), and confirm that your ψ 's can be obtained from mine (Equation 2.24) by the substitution $x \rightarrow x - a/2$.

***Problem 2.5** Calculate $\langle x \rangle$, $\langle x^2 \rangle$, $\langle p \rangle$, $\langle p^2 \rangle$, σ_x , and σ_p , for the n th stationary state of the infinite square well. Check that the uncertainty principle is satisfied. Which state comes closest to the uncertainty limit?

****Problem 2.6** A particle in the infinite square well has as its initial wave function an even mixture of the first two stationary states:

$$\Psi(x, 0) = A[\psi_1(x) + \psi_2(x)].$$

- (a) Normalize $\Psi(x, 0)$. (That is, find A . This is very easy if you exploit the orthonormality of ψ_1 and ψ_2 . Recall that, having normalized Ψ at $t = 0$, you can rest assured that it *stays* normalized—if you doubt this, check it explicitly after doing part b.)
- (b) Find $\Psi(x, t)$ and $|\Psi(x, t)|^2$. (Express the latter in terms of sinusoidal functions of time, eliminating the exponentials with the help of **Euler's formula**: $e^{i\theta} = \cos\theta + i\sin\theta$.) Let $\omega \equiv \pi^2\hbar/2ma^2$.
- (c) Compute $\langle x \rangle$. Notice that it oscillates in time. What is the frequency of the oscillation? What is the amplitude of the oscillation? (If your amplitude is greater than $a/2$, go directly to jail.)

- (d) Compute $\langle p \rangle$. (As Peter Lorre would say, “Do it ze *kveek* vay, Johnny!”)
- (e) Find the expectation value of H . How does it compare with E_1 and E_2 ?
- (f) A *classical* particle in this well would bounce back and forth between the walls. If its energy is equal to the expectation value you found in (e), what is the frequency of the classical motion? How does it compare with the quantum frequency you found in (c)?

Problem 2.7 Although the *overall* phase constant of the wave function is of no physical significance (it cancels out whenever you calculate a measurable quantity), the *relative* phase of the expansion coefficients in Equation 2.14 *does* matter. For example, suppose we change the relative phase of ψ_1 and ψ_2 in Problem 2.6:

$$\Psi(x, 0) = A[\psi_1(x) + e^{i\phi}\psi_2(x)],$$

where ϕ is some constant. Find $\Psi(x, t)$, $|\Psi(x, t)|^2$, and $\langle x \rangle$, and compare your results with what you got before. Study the special cases $\phi = \pi/2$ and $\phi = \pi$.

***Problem 2.8** A particle in the infinite square well has the initial wave function

$$\Psi(x, 0) = Ax(a - x).$$

- (a) Normalize $\Psi(x, 0)$. Graph it. Which stationary state does it most closely resemble? On that basis, estimate the expectation value of the energy.
- (b) Compute $\langle x \rangle$, $\langle p \rangle$, and $\langle H \rangle$, at $t = 0$. (*Note:* This time you cannot get $\langle p \rangle$ by differentiating $\langle x \rangle$, because you only know $\langle x \rangle$ at one instant of time.) How does $\langle H \rangle$ compare with your estimate in (a)?

***Problem 2.9** Find $\Psi(x, t)$ for the initial wave function in Problem 2.8. Evaluate c_1 , c_2 , and c_3 numerically, to five decimal places, and comment on these numbers. (c_n tells you, roughly speaking, how much ψ_n is “contained in” Ψ .) Suppose you measured the energy at time $t_0 > 0$, and got the value E_3 . Knowing that immediate repetition of the measurement must return the same value, what can you say about the coefficients c_n *after* the measurement? (This is an example of the “collapse of the wave function”, which we discussed briefly in Chapter 1.)

***Problem 2.10** The wave function (Equation 2.14) has got to be normalized; given that the ψ_n 's are orthonormal, what does this tell you about the coefficients c_n ? *Answer:*

$$\sum_{n=1}^{\infty} |c_n|^2 = 1. \quad [2.34]$$

(In particular, $|c_n|^2$ is always ≤ 1 .) Show that

$$\langle H \rangle = \sum_{n=1}^{\infty} E_n |c_n|^2. \quad [2.35]$$

Incidentally, it follows that $\langle H \rangle$ is constant in time, which is one manifestation of **conservation of energy** in quantum mechanics.

2.3 THE HARMONIC OSCILLATOR

The paradigm for a classical harmonic oscillator is a mass m attached to a spring of force constant k . The motion is governed by **Hooke's law**,

$$F = -kx = m \frac{d^2x}{dt^2}$$

(as always, we ignore friction), and the solution is

$$x(t) = A \sin(\omega t) + B \cos(\omega t),$$

where

$$\omega \equiv \sqrt{\frac{k}{m}} \quad [2.36]$$

is the (angular) frequency of oscillation. The potential energy is

$$V(x) = \frac{1}{2}kx^2; \quad [2.37]$$

its graph is a parabola.

Of course, there's no such thing as a *perfect* simple harmonic oscillator—if you stretch it too far the spring is going to break, and typically Hooke's law fails long before that point is reached. But practically any potential is *approximately* parabolic, in the neighborhood of a local minimum (Figure 2.3). Formally, if we expand $V(x)$ in a **Taylor series** about the minimum:

$$V(x) = V(x_0) + V'(x_0)(x - x_0) + \frac{1}{2}V''(x_0)(x - x_0)^2 + \dots,$$

subtract $V(x_0)$ [you can add a constant to $V(x)$ with impunity, since that doesn't change the force], recognize that $V'(x_0) = 0$ (since x_0 is a minimum), and drop the higher-order terms [which are negligible as long as $(x - x_0)$ stays small], the potential becomes

$$V(x) \cong \frac{1}{2}V''(x_0)(x - x_0)^2,$$

which describes simple harmonic oscillation (about the point x_0), with an effective spring constant $k = V''(x_0)$.¹⁰ That's why the simple harmonic oscillator is so important: Virtually *any* oscillatory motion is approximately simple harmonic, as long as the amplitude is small.

¹⁰Note that $V''(x_0) \geq 0$, since by assumption x_0 is a minimum. Only in the rare case $V''(x_0) = 0$ is the oscillation not even approximately simple harmonic.

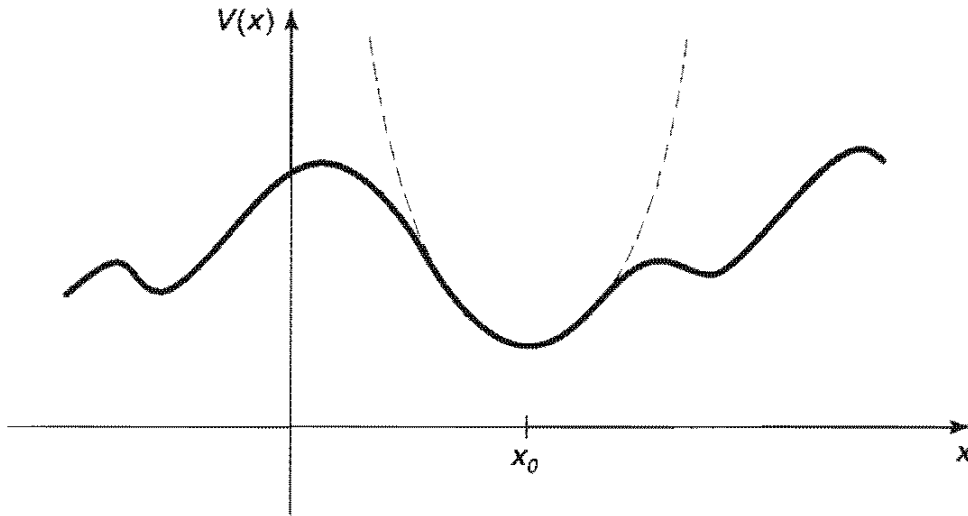

Figure 2.3: Parabolic approximation (dashed curve) to an arbitrary potential, in the neighborhood of a local minimum.

The *quantum* problem is to solve the Schrödinger equation for the potential

$$V(x) = \frac{1}{2}m\omega^2x^2 \quad [2.38]$$

(it is customary to eliminate the spring constant in favor of the classical frequency, using Equation 2.36). As we have seen, it suffices to solve the time-independent Schrödinger equation:

$$-\frac{\hbar^2}{2m} \frac{d^2\psi}{dx^2} + \frac{1}{2}m\omega^2x^2\psi = E\psi. \quad [2.39]$$

In the literature you will find two entirely different approaches to this problem. The first is a straightforward “brute force” solution to the differential equation, using the method of **power series expansion**; it has the virtue that the same strategy can be applied to many other potentials (in fact, we’ll use it in Chapter 4 to treat the Coulomb potential). The second is a diabolically clever algebraic technique, using so-called **ladder operators**. I’ll show you the algebraic method first, because it is quicker and simpler (and more fun); if you want to skip the analytic method for now, that’s fine, but you should certainly plan to study it at some stage.

2.3.1 Algebraic Method

To begin with, let’s rewrite Equation 2.39 in a more suggestive form:

$$\frac{1}{2m} \left[\left(\frac{\hbar}{i} \frac{d}{dx} \right)^2 + (m\omega x)^2 \right] \psi = E\psi. \quad [2.40]$$

The idea is to *factor* the term in square brackets. If these were *numbers*, it would be easy:

$$u^2 + v^2 = (u - iv)(u + iv).$$

Here, however, it's not quite so simple, because u and v are *operators*, and operators do not, in general, **commute** (uv is not the same as vu). Still, this does invite us to take a look at the expressions

$$a_{\pm} \equiv \frac{1}{\sqrt{2m}} \left(\frac{\hbar}{i} \frac{d}{dx} \pm im\omega x \right). \quad [2.41]$$

What is their product, a_-a_+ ? *Warning:* Operators can be slippery to work with in the abstract, and you are bound to make mistakes unless you give them a “test function”, $f(x)$, to act on. At the end you can throw away the test function, and you'll be left with an equation involving the operators alone. In the present case, we have

$$\begin{aligned} (a_-a_+)f(x) &= \frac{1}{2m} \left(\frac{\hbar}{i} \frac{d}{dx} - im\omega x \right) \left(\frac{\hbar}{i} \frac{d}{dx} + im\omega x \right) f(x) \\ &= \frac{1}{2m} \left(\frac{\hbar}{i} \frac{d}{dx} - im\omega x \right) \left(\frac{\hbar}{i} \frac{df}{dx} + im\omega x f \right) \\ &= \frac{1}{2m} \left[-\hbar^2 \frac{d^2 f}{dx^2} + \hbar m \omega \frac{d}{dx} (x f) - \hbar m \omega x \frac{df}{dx} + (m\omega x)^2 f \right] \\ &= \frac{1}{2m} \left[\left(\frac{\hbar}{i} \frac{d}{dx} \right)^2 + (m\omega x)^2 + \hbar m \omega \right] f(x). \end{aligned}$$

[I used $d(xf)/dx = x(df/dx) + f$ in the last step.] Discarding the test function, we conclude that

$$a_-a_+ = \frac{1}{2m} \left[\left(\frac{\hbar}{i} \frac{d}{dx} \right)^2 + (m\omega x)^2 \right] + \frac{1}{2} \hbar \omega. \quad [2.42]$$

Evidently Equation 2.40 does *not* factor perfectly—there's an extra term $(1/2)\hbar\omega$. However, if we pull this over to the other side, the Schrödinger equation¹¹ becomes

$$(a_-a_+ - \frac{1}{2} \hbar \omega) \psi = E \psi. \quad [2.43]$$

Notice that the ordering of the factors a_+ and a_- is important here; the same argument, with a_+ on the left, yields

$$a_+a_- = \frac{1}{2m} \left[\left(\frac{\hbar}{i} \frac{d}{dx} \right)^2 + (m\omega x)^2 \right] - \frac{1}{2} \hbar \omega. \quad [2.44]$$

Thus

$$a_-a_+ - a_+a_- = \hbar \omega, \quad [2.45]$$

¹¹I'm getting tired of writing “time-independent Schrödinger equation,” so when it's clear from the context which one I mean, I'll just call it the Schrödinger equation.

and the Schrödinger equation can also be written

$$(a_+a_- + \frac{1}{2}\hbar\omega)\psi = E\psi. \quad [2.46]$$

Now, here comes the crucial step: I claim that *if ψ satisfies the Schrödinger equation, with energy E , then $a_+\psi$ satisfies the Schrödinger equation with energy $(E + \hbar\omega)$* . Proof:

$$\begin{aligned} (a_+a_- + \frac{1}{2}\hbar\omega)(a_+\psi) &= (a_+a_-a_+ + \frac{1}{2}\hbar\omega a_+)\psi \\ &= a_+(a_-a_+ + \frac{1}{2}\hbar\omega)\psi = a_+[(a_-a_+ - \frac{1}{2}\hbar\omega)\psi + \hbar\omega\psi] \\ &= a_+(E\psi + \hbar\omega\psi) = (E + \hbar\omega)(a_+\psi). \text{ QED} \end{aligned}$$

[Notice that whereas the ordering of a_+ and a_- *does* matter, the ordering of a_{\pm} and any *constants* (such as \hbar , ω , and E) does not.] By the same token, $a_-\psi$ is a solution with energy $(E - \hbar\omega)$:

$$\begin{aligned} (a_-a_+ - \frac{1}{2}\hbar\omega)(a_-\psi) &= a_-(a_+a_- - \frac{1}{2}\hbar\omega)\psi \\ &= a_-[(a_+a_- + \frac{1}{2}\hbar\omega)\psi - \hbar\omega\psi] = a_-(E\psi - \hbar\omega\psi) \\ &= (E - \hbar\omega)(a_-\psi). \end{aligned}$$

Here, then, is a wonderful machine for grinding out new solutions, with higher and lower energies—if we can just find *one* solution, to get started! We call a_{\pm} **ladder operators**, because they allow us to climb up and down in energy; a_+ is called the **raising operator**, and a_- the **lowering operator**. The “ladder” of states is illustrated in Figure 2.4.

But wait! What if I apply the lowering operator repeatedly? Eventually I’m going to reach a state with energy less than zero, which (according to the general theorem in Problem 2.2) does not exist! At some point the machine must fail. How can that happen? We know that $a_-\psi$ is a new solution to the Schrödinger equation, but *there is no guarantee that it will be normalizable*—it might be zero, or its square integral might be infinite. Problem 2.11 rules out the latter possibility. Conclusion: There must occur a “lowest rung” (let’s call it ψ_0) such that

$$a_-\psi_0 = 0. \quad [2.47]$$

That is to say,

$$\frac{1}{\sqrt{2m}} \left(\frac{\hbar}{i} \frac{d\psi_0}{dx} - im\omega x \psi_0 \right) = 0,$$

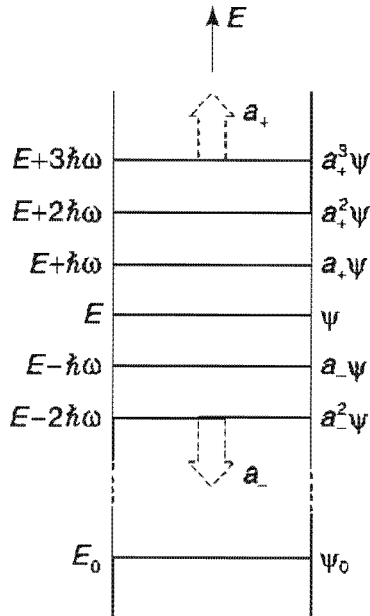

Figure 2.4: The ladder of stationary states for the simple harmonic oscillator.

or

$$\frac{d\psi_0}{dx} = -\frac{m\omega}{\hbar}x\psi_0.$$

This differential equation for ψ_0 is easy to solve:

$$\int \frac{d\psi_0}{\psi_0} = -\frac{m\omega}{\hbar} \int x dx \Rightarrow \ln \psi_0 = -\frac{m\omega}{2\hbar}x^2 + \text{constant},$$

so

$$\psi_0(x) = A_0 e^{-\frac{m\omega}{2\hbar}x^2}. \quad [2.48]$$

To determine the energy of this state, we plug it into the Schrödinger equation (in the form of Equation 2.46), $(a_+a_- + (1/2)\hbar\omega)\psi_0 = E_0\psi_0$, and exploit the fact that $a_-\psi_0 = 0$. Evidently

$$E_0 = \frac{1}{2}\hbar\omega. \quad [2.49]$$

With our foot now securely planted on the bottom rung¹² (the ground state of the quantum oscillator), we simply apply the raising operator to generate the excited states¹³:

$$\psi_n(x) = A_n (a_+)^n e^{-\frac{m\omega}{2\hbar}x^2}, \quad \text{with } E_n = \left(n + \frac{1}{2}\right)\hbar\omega. \quad [2.50]$$

¹²Note that there can only be *one* ladder, because the lowest state is uniquely determined by Equation 2.47. Thus we have in fact obtained *all* the (normalizable) solutions.

¹³In the case of the harmonic oscillator, it is convenient to depart from our usual custom and number the states starting with $n = 0$ instead of $n = 1$. Obviously, the lower limit on the sum in equations such as Equation 2.14 should be altered accordingly.

(This method does not immediately determine the normalization factor A_n ; I'll let you work that out for yourself in Problem 2.12.) For example,

$$\begin{aligned}\psi_1 &= A_1 a_+ e^{-\frac{m\omega}{2\hbar}x^2} = A_1 \frac{1}{\sqrt{2m}} \left(\frac{\hbar}{i} \frac{d}{dx} + im\omega x \right) e^{-\frac{m\omega}{2\hbar}x^2} \\ &= \frac{A_1}{\sqrt{2m}} \left[\frac{\hbar}{i} \left(-\frac{m\omega}{\hbar} x \right) e^{-\frac{m\omega}{2\hbar}x^2} + im\omega x e^{-\frac{m\omega}{2\hbar}x^2} \right],\end{aligned}$$

which simplifies to

$$\psi_1(x) = (iA_1\omega\sqrt{2m})xe^{-\frac{m\omega}{2\hbar}x^2}. \quad [2.51]$$

I wouldn't want to calculate ψ_{50} in this way, but never mind: We have found all the allowed energies, and in principle we have determined the stationary states—the rest is just computation.

Problem 2.11 Show that the lowering operator cannot generate a state of infinite norm (i.e., $\int |a_- \psi|^2 dx < \infty$, if ψ itself is a normalized solution to the Schrödinger equation). What does this tell you in the case $\psi = \psi_0$? *Hint:* Use integration by parts to show that

$$\int_{-\infty}^{\infty} (a_- \psi)^* (a_- \psi) dx = \int_{-\infty}^{\infty} \psi^* (a_+ a_- \psi) dx.$$

Then invoke the Schrödinger equation (Equation 2.46) to obtain

$$\int_{-\infty}^{\infty} |a_- \psi|^2 dx = E - \frac{1}{2}\hbar\omega,$$

where E is the energy of the state ψ .

****Problem 2.12**

- (a) The raising and lowering operators generate new solutions to the Schrödinger equation, but these new solutions are not correctly normalized. Thus $a_+ \psi_n$ is *proportional* to ψ_{n+1} , and $a_- \psi_n$ is *proportional* to ψ_{n-1} , but we'd like to know the precise proportionality constants. Use integration by parts and the Schrödinger equation (Equations 2.43 and 2.46) to show that

$$\int_{-\infty}^{\infty} |a_+ \psi_n|^2 dx = (n+1)\hbar\omega, \quad \int_{-\infty}^{\infty} |a_- \psi_n|^2 dx = n\hbar\omega,$$

and hence (with i 's to keep the wavefunctions real)

$$a_+ \psi_n = i\sqrt{(n+1)\hbar\omega} \psi_{n+1}, \quad [2.52]$$

$$a_- \psi_n = -i\sqrt{n\hbar\omega} \psi_{n-1}. \quad [2.53]$$

- (b) Use Equation 2.52 to determine the normalization constant A_n in Equation 2.50. (You'll have to normalize ψ_0 "by hand".) *Answer:*

$$A_n = \left(\frac{m\omega}{\pi\hbar} \right)^{1/4} \frac{(-i)^n}{\sqrt{n!(\hbar\omega)^n}}. \quad [2.54]$$

***Problem 2.13** Using the methods and results of this section,

- (a) Normalize ψ_1 (Equation 2.51) by direct integration. Check your answer against the general formula (Equation 2.54).
 (b) Find ψ_2 , but don't bother to normalize it.
 (c) Sketch ψ_0 , ψ_1 , and ψ_2 .
 (d) Check the orthogonality of ψ_0 , ψ_1 , and ψ_2 . *Note:* If you exploit the evenness and oddness of the functions, there is really only one integral left to evaluate explicitly.

***Problem 2.14** Using the results of Problems 2.12 and 2.13,

- (a) Compute $\langle x \rangle$, $\langle p \rangle$, $\langle x^2 \rangle$, and $\langle p^2 \rangle$, for the states ψ_0 and ψ_1 . *Note:* In this and most problems involving the harmonic oscillator, it simplifies the notation if you introduce the variable $\xi \equiv \sqrt{m\omega/\hbar} x$ and the constant $\alpha \equiv (m\omega/\pi\hbar)^{1/4}$.
 (b) Check the uncertainty principle for these states.
 (c) Compute $\langle T \rangle$ and $\langle V \rangle$ for these states (no new integration allowed!). Is their sum what you would expect?

2.3.2 Analytic Method

We return now to the Schrödinger equation for the harmonic oscillator (Equation 2.39):

$$-\frac{\hbar^2}{2m} \frac{d^2\psi}{dx^2} + \frac{1}{2}m\omega^2 x^2 \psi = E\psi.$$

Things look a little cleaner if we introduce the dimensionless variable

$$\xi \equiv \sqrt{\frac{m\omega}{\hbar}} x; \quad [2.55]$$

in terms of ξ , the Schrödinger equation reads

$$\frac{d^2\psi}{d\xi^2} = (\xi^2 - K)\psi, \quad [2.56]$$

where K is the energy, in units of $(1/2)\hbar\omega$:

$$K \equiv \frac{2E}{\hbar\omega}. \quad [2.57]$$

Our problem is to solve Equation 2.56, and in the process obtain the “allowed” values of K (and hence of E).

To begin with, note that at very large ξ (which is to say, at very large x), ξ^2 completely dominates over the constant K , so in this regime

$$\frac{d^2\psi}{d\xi^2} \approx \xi^2\psi, \quad [2.58]$$

which has the approximate solution (check it!)

$$\psi(\xi) \approx Ae^{-\xi^2/2} + Be^{+\xi^2/2}. \quad [2.59]$$

The B term is clearly not normalizable (it blows up as $|x| \rightarrow \infty$); the physically acceptable solutions, then, have the asymptotic form

$$\psi(\xi) \rightarrow ()e^{-\xi^2/2}, \quad \text{at large } \xi. \quad [2.60]$$

This suggests that we “peel off” the exponential part,

$$\psi(\xi) = h(\xi)e^{-\xi^2/2}, \quad [2.61]$$

in hopes that what remains [$h(\xi)$] has a simpler functional form than $\psi(\xi)$ itself.¹⁴ Differentiating Equation 2.61, we have

$$\frac{d\psi}{d\xi} = \left(\frac{dh}{d\xi} - \xi h \right) e^{-\xi^2/2}$$

and

$$\frac{d^2\psi}{d\xi^2} = \left(\frac{d^2h}{d\xi^2} - 2\xi \frac{dh}{d\xi} + (\xi^2 - 1)h \right) e^{-\xi^2/2},$$

so the Schrödinger equation (Equation 2.56) becomes

$$\frac{d^2h}{d\xi^2} - 2\xi \frac{dh}{d\xi} + (K - 1)h = 0. \quad [2.62]$$

I propose to look for a solution to Equation 2.62 in the form of a power series in ξ ¹⁵:

$$h(\xi) = a_0 + a_1\xi + a_2\xi^2 + \cdots = \sum_{j=0}^{\infty} a_j\xi^j. \quad [2.63]$$

¹⁴Note that although we invoked some approximations to motivate Equation 2.61, what follows is *exact*. The device of stripping off the asymptotic behavior is the standard first step in the power series method for solving differential equations—see, for example, Boas (cited in footnote 8), Chapter 12.

¹⁵According to Taylor’s theorem, any reasonably well-behaved function can be expressed as a power series, so Equation 2.63 involves no real loss of generality. For conditions on the applicability of the series method, see Boas (cited in footnote 8) or George Arfken, *Mathematical Methods for Physicists*, 3rd ed. (Orlando, FL: Academic Press, 1985), Section 8.5.

Differentiating the series term by term,

$$\frac{dh}{d\xi} = a_1 + 2a_2\xi + 3a_3\xi^2 + \cdots = \sum_{j=0}^{\infty} ja_j\xi^{j-1},$$

and

$$\frac{d^2h}{d\xi^2} = 2a_2 + 2 \cdot 3a_3\xi + 3 \cdot 4a_4\xi^2 + \cdots = \sum_{j=0}^{\infty} (j+1)(j+2)a_{j+2}\xi^j.$$

Putting these into Equation 2.62, we find

$$\sum_{j=0}^{\infty} [(j+1)(j+2)a_{j+2} - 2ja_j + (K-1)a_j] \xi^j = 0. \quad [2.64]$$

It follows (from the uniqueness of power series expansions¹⁶) that the coefficient of *each power* of ξ must vanish,

$$(j+1)(j+2)a_{j+2} - 2ja_j + (K-1)a_j = 0,$$

and hence that

$$a_{j+2} = \frac{(2j+1-K)}{(j+1)(j+2)} a_j. \quad [2.65]$$

This **recursion formula** is entirely equivalent to the Schrödinger equation itself. Given a_0 it enables us (in principle) to generate a_2, a_4, a_6, \dots , and given a_1 it generates a_3, a_5, a_7, \dots . Let us write

$$h(\xi) = h_{\text{even}}(\xi) + h_{\text{odd}}(\xi), \quad [2.66]$$

where

$$h_{\text{even}}(\xi) \equiv a_0 + a_2\xi^2 + a_4\xi^4 + \cdots$$

is an *even* function of ξ (since it involves only even powers), built on a_0 , and

$$h_{\text{odd}}(\xi) \equiv a_1\xi + a_3\xi^3 + a_5\xi^5 + \cdots$$

is an *odd* function, built on a_1 . Thus Equation 2.65 determines $h(\xi)$ in terms of two arbitrary constants (a_0 and a_1)—which is just what we would expect, for a second-order differential equation.

However, not all the solutions so obtained are normalizable. For at very large j , the recursion formula becomes (approximately)

$$a_{j+2} \approx \frac{2}{j} a_j,$$

¹⁶See, for example, Arfken (footnote 15), Section 5.7.

with the (approximate) solution

$$a_j \approx \frac{C}{(j/2)!},$$

for some constant C , and this yields (at large ξ , where the higher powers dominate)

$$h(\xi) \approx C \sum \frac{1}{(j/2)!} \xi^j \approx C \sum \frac{1}{k!} \xi^{2k} \approx C e^{\xi^2}.$$

Now, if h goes like $\exp(\xi^2)$, then ψ (remember ψ ?—that's what we're trying to calculate) goes like $\exp(\xi^2/2)$ (Equation 2.61), which is precisely the asymptotic behavior we *don't* want.¹⁷ There is only one way to wiggle out of this: For normalizable solutions *the power series must terminate*. There must occur some “highest” j (call it n) such that the recursion formula spits out $a_{n+2} = 0$ (this will truncate *either* the series h_{even} *or* the series h_{odd} ; the *other* one must be zero from the start). For physically acceptable solutions, then, we must have

$$K = 2n + 1,$$

for some positive integer n , which is to say (referring to Equation 2.57) that the *energy* must be of the form

$$E_n = \left(n + \frac{1}{2}\right) \hbar \omega, \quad \text{for } n = 0, 1, 2, \dots \quad [2.67]$$

Thus we recover, by a completely different method, the fundamental quantization condition we found algebraically in Equation 2.50.

For the allowed values of K , the recursion formula reads

$$a_{j+2} = \frac{-2(n-j)}{(j+1)(j+2)} a_j. \quad [2.68]$$

If $n = 0$, there is only one term in the series (we must pick $a_1 = 0$ to kill h_{odd} , and $j = 0$ in Equation 2.68 yields $a_2 = 0$):

$$h_0(\xi) = a_0,$$

and hence

$$\psi_0(\xi) = a_0 e^{-\xi^2/2}$$

(which reproduces Equation 2.48). For $n = 1$ we pick $a_0 = 0$,¹⁸ and Equation 2.68 with $j = 1$ yields $a_3 = 0$, so

$$h_1(\xi) = a_1 \xi,$$

¹⁷It's no surprise that the ill-behaved solutions are still contained in Equation 2.65; this recursion relation is equivalent to the Schrödinger equation, so it's got to include both the asymptotic forms we found in Equation 2.59.

¹⁸Note that there is a completely different set of coefficients a_j for each value of n .

and hence

$$\psi_1(\xi) = a_1 \xi e^{-\xi^2/2}$$

(confirming Equation 2.51). For $n = 2$, $j = 0$ yields $a_2 = -2a_0$, and $j = 2$ gives $a_4 = 0$, so

$$h_2(\xi) = a_0(1 - 2\xi^2)$$

and

$$\psi_2(\xi) = a_0(1 - 2\xi^2)e^{-\xi^2/2},$$

and so on. (Compare Problem 2.13, where the same result was obtained by algebraic means.)

In general, $h_n(\xi)$ will be a polynomial of degree n in ξ , involving even powers only, if n is an even integer, and odd powers only, if n is an odd integer. Apart from the overall factor (a_0 or a_1) they are the so-called **Hermite polynomials**, $H_n(\xi)$.¹⁹ The first few of them are listed in Table 2.1. By tradition, the arbitrary multiplicative factor is chosen so that the coefficient of the highest power of ξ is 2^n . With this convention, the normalized²⁰ stationary states for the harmonic oscillator are

$$\psi_n(x) = \left(\frac{m\omega}{\pi\hbar}\right)^{1/4} \frac{1}{\sqrt{2^n n!}} H_n(\xi) e^{-\xi^2/2}. \quad [2.69]$$

They are identical (of course) to the ones we obtained algebraically in Equation 2.50. In Figure 2.5a I have plotted $\psi_n(x)$ for the first few n 's.

The quantum oscillator is strikingly different from its classical counterpart—not only are the energies quantized, but the position distributions have some bizarre features. For instance, the probability of finding the particle outside the classically allowed range (that is, with x greater than the classical amplitude for the energy in question) is *not* zero (see Problem 2.15), and in all odd states the probability of

Table 2.1: The first few Hermite polynomials, $H_n(x)$.

| |
|--------------------------------|
| $H_0 = 1,$ |
| $H_1 = 2x,$ |
| $H_2 = 4x^2 - 2,$ |
| $H_3 = 8x^3 - 12x,$ |
| $H_4 = 16x^4 - 48x^2 + 12,$ |
| $H_5 = 32x^5 - 160x^3 + 120x.$ |

¹⁹The Hermite polynomials have been studied extensively in the mathematical literature, and there are many tools and tricks for working with them. A few of these are explored in Problem 2.18.

²⁰I shall not work out the normalization constant here; if you are interested in knowing how it is done, see, for example, Leonard Schiff, *Quantum Mechanics*, 3rd ed. (New York: McGraw-Hill, 1968), Section 13.

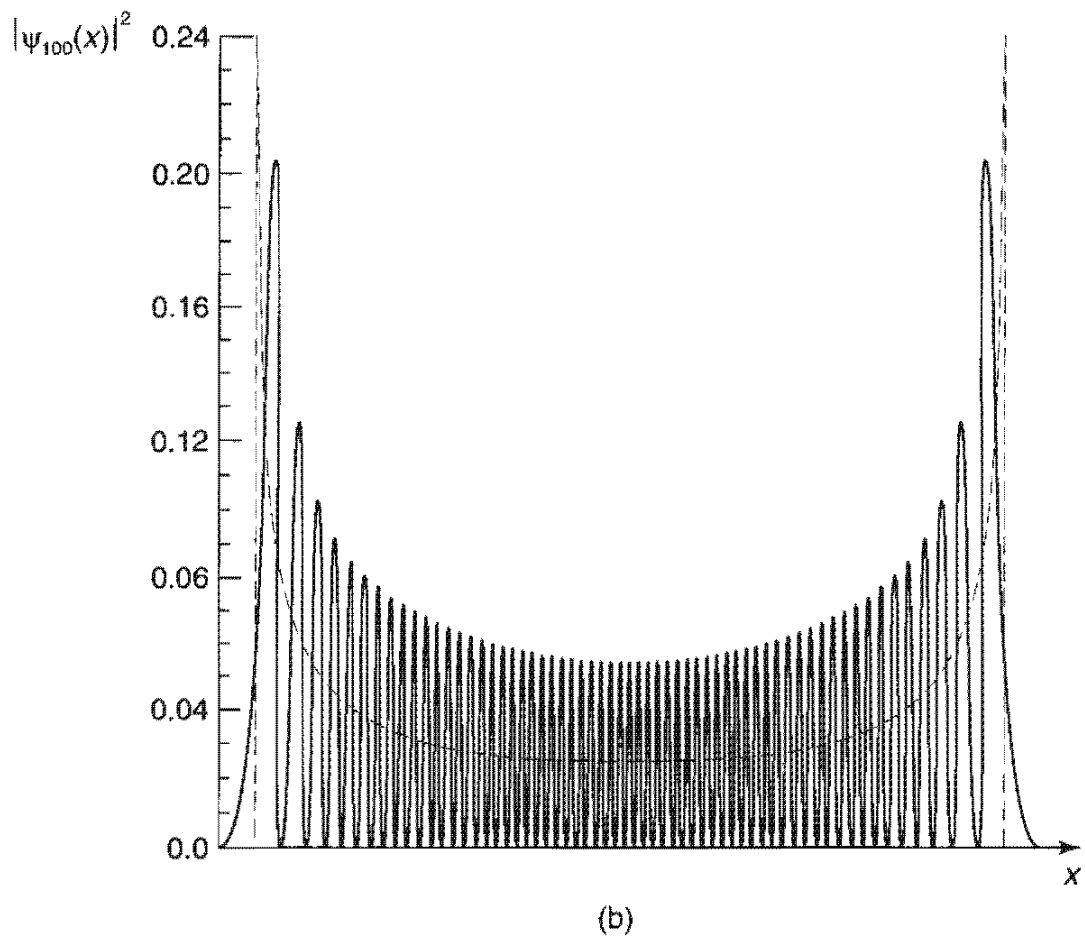
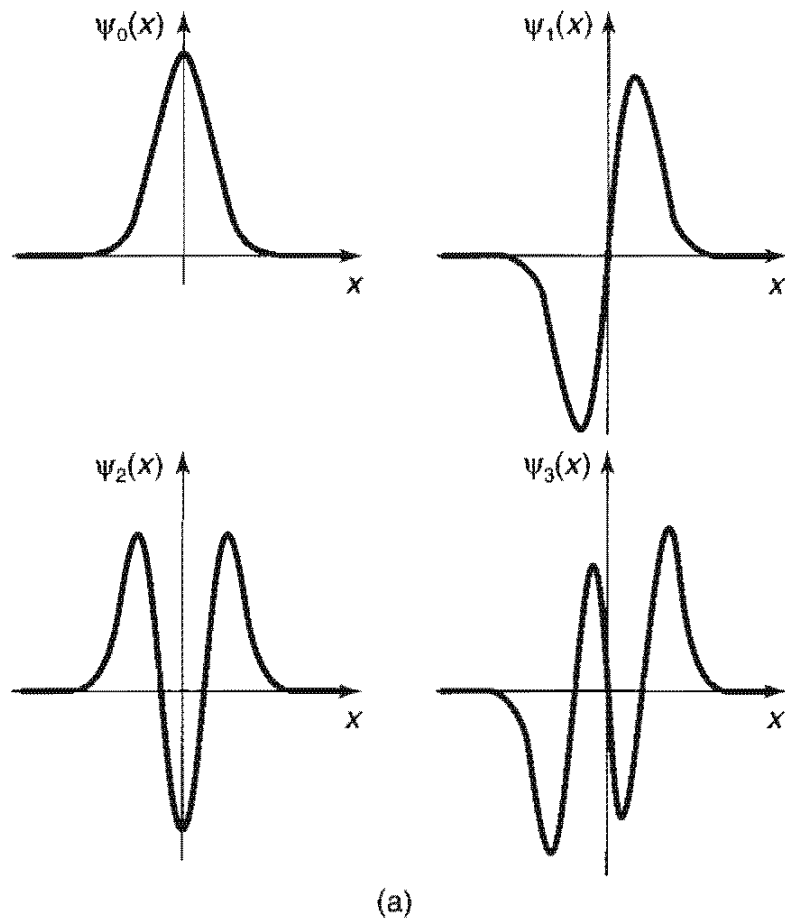

Figure 2.5: (a) The first four stationary states of the harmonic oscillator. (b) Graph of $|\psi_{100}|^2$, with the classical distribution (dashed curve) superimposed.

finding the particle at the center of the potential well is zero. Only at relatively large n do we begin to see some resemblance to the classical case. In Figure 2.5b I have superimposed the classical position distribution on the quantum one (for $n = 100$); if you smoothed out the bumps in the latter, the two would fit pretty well (however, in the classical case we are talking about the distribution of positions over *time* for *one* oscillator, whereas in the quantum case we are talking about the distribution over an *ensemble* of identically-prepared systems).²¹

Problem 2.15 In the ground state of the harmonic oscillator, what is the probability (correct to three significant digits) of finding the particle outside the classically allowed region? *Hint:* Look in a math table under “Normal Distribution” or “Error Function”.

Problem 2.16 Use the recursion formula (Equation 2.68) to work out $H_5(\xi)$ and $H_6(\xi)$.

***Problem 2.17** A particle in the harmonic oscillator potential has the initial wave function

$$\Psi(x, 0) = A[\psi_0(x) + \psi_1(x)]$$

for some constant A .

- (a) Normalize $\Psi(x, 0)$.
- (b) Find $\Psi(x, t)$ and $|\Psi(x, t)|^2$.
- (c) Find the expectation value of x as a function of time. Notice that it oscillates sinusoidally. What is the amplitude of the oscillation? What is its (angular) frequency?
- (d) Use your result in (c) to determine $\langle p \rangle$. Check that Ehrenfest’s theorem holds for this wave function.
- (e) Referring to Figure 2.5, sketch the graph of $|\Psi|$ at $t = 0, \pi/\omega, 2\pi/\omega, 3\pi/\omega$, and $4\pi/\omega$. (Your graphs don’t have to be fancy—just a rough picture to show the oscillation.)

****Problem 2.18** In this problem we explore some of the more useful theorems (stated without proof) involving Hermite polynomials.

- (a) The **Rodrigues formula** states that

$$H_n(\xi) = (-1)^n e^{\xi^2} \left(\frac{d}{d\xi} \right)^n e^{-\xi^2}. \quad [2.70]$$

Use it to derive H_3 and H_4 .

²¹The analogy is perhaps more telling if you interpret the classical distribution as an ensemble of oscillators all with the same energy, but with random starting times.

- (b) The following recursion relation gives you H_{n+1} in terms of the two preceding Hermite polynomials:

$$H_{n+1}(\xi) = 2\xi H_n(\xi) - 2nH_{n-1}(\xi). \quad [2.71]$$

Use it, together with your answer to (a), to obtain H_5 and H_6 .

- (c) If you differentiate an n th-order polynomial, you get a polynomial of order $(n - 1)$. For the Hermite polynomials, in fact,

$$\frac{dH_n}{d\xi} = 2nH_{n-1}(\xi). \quad [2.72]$$

Check this, by differentiating H_5 and H_6 .

- (d) $H_n(\xi)$ is the n th z -derivative, at $z = 0$, of the **generating function** $\exp(-z^2 + 2z\xi)$; or, to put it another way, it is the coefficient of $z^n/n!$ in the Taylor series expansion for this function:

$$e^{-z^2+2z\xi} = \sum_{n=0}^{\infty} \frac{z^n}{n!} H_n(\xi). \quad [2.73]$$

Use this to rederive H_0 , H_1 , and H_2 .

2.4 THE FREE PARTICLE

We turn next to what should have been the simplest case of all: the free particle [$V(x) = 0$ everywhere]. As you'll see in a moment, the free particle is in fact a surprisingly subtle and tricky example. The time-independent Schrödinger equation reads

$$-\frac{\hbar^2}{2m} \frac{d^2\psi}{dx^2} = E\psi, \quad [2.74]$$

or

$$\frac{d^2\psi}{dx^2} = -k^2\psi, \quad \text{where } k \equiv \frac{\sqrt{2mE}}{\hbar}. \quad [2.75]$$

So far, it's the same as inside the infinite square well (Equation 2.17), where the potential is also zero; this time, however, I prefer to write the general solution in exponential form (instead of sines and cosines) for reasons that will appear in due course:

$$\psi(x) = Ae^{ikx} + Be^{-ikx}. \quad [2.76]$$

Unlike the infinite square well, there are no boundary conditions to restrict the possible values of k (and hence of E); the free particle can carry *any* (positive) energy. Tacking on the standard time dependence, $\exp(-iEt/\hbar)$,

$$\Psi(x, t) = Ae^{ik(x - \frac{\hbar k}{2m}t)} + Be^{-ik(x + \frac{\hbar k}{2m}t)}. \quad [2.77]$$

Now, any function of x and t that depends on these variables in the special combination $(x \pm vt)$ (for some constant v) represents a wave of fixed profile, traveling in the $\mp x$ -direction, at speed v . A fixed point on the waveform (for example, a maximum or a minimum) corresponds to a fixed value of the argument, and hence to x and t such that

$$x \pm vt = \text{constant}, \quad \text{or} \quad x = \mp vt + \text{constant},$$

which is the formula for motion in the $\mp x$ -direction with constant speed v . Since every point on the waveform is moving along with the same velocity, its shape doesn't change as it propagates. Thus the first term in Equation 2.77 represents a wave traveling to the *right*, and the second term represents a wave (of the same energy) going to the *left*. By the way, since they only differ by the sign in front of k , we might as well write

$$\Psi_k(x, t) = Ae^{i(kx - \frac{\hbar k^2}{2m}t)}, \quad [2.78]$$

and let k run negative to cover the case of waves traveling to the left:

$$k \equiv \pm \frac{\sqrt{2mE}}{\hbar}, \quad \text{with} \quad \begin{cases} k > 0 \Rightarrow & \text{traveling to the right,} \\ k < 0 \Rightarrow & \text{traveling to the left.} \end{cases} \quad [2.79]$$

The speed of these waves (the coefficient of t over the coefficient of x) is

$$v_{\text{quantum}} = \frac{\hbar|k|}{2m} = \sqrt{\frac{E}{2m}}. \quad [2.80]$$

On the other hand, the *classical* speed of a free particle with energy E is given by $E = (1/2)mv^2$ (pure kinetic, since $V = 0$), so

$$v_{\text{classical}} = \sqrt{\frac{2E}{m}} = 2v_{\text{quantum}}. \quad [2.81]$$

Evidently the quantum mechanical wave function travels at *half* the speed of the particle it is supposed to represent! We'll return to this paradox in a moment—there is an even more serious problem we need to confront first: *This wave function is not normalizable!* For

$$\int_{-\infty}^{+\infty} \Psi_k^* \Psi_k dx = |A|^2 \int_{-\infty}^{+\infty} 1 dx = |A|^2(\infty). \quad [2.82]$$

In the case of the free particle, then, the separable solutions do not represent physically realizable states. A free particle cannot exist in a stationary state; or, to put it another way, *there is no such thing as a free particle with a definite energy.*

But that doesn't mean the separable solutions are of no use to us. For they play a *mathematical* role that is entirely independent of their *physical* interpretation: The general solution to the time-dependent Schrödinger equation is still a linear

combination of separable solutions (only this time it's an integral over the continuous variable k , instead of a sum over the discrete index n):

$$\Psi(x, t) = \frac{1}{\sqrt{2\pi}} \int_{-\infty}^{+\infty} \phi(k) e^{i(kx - \frac{\hbar k^2}{2m} t)} dk. \quad [2.83]$$

[The quantity $1/\sqrt{2\pi}$ is factored out for convenience; what plays the role of the coefficient c_n in Equation 2.14 is the combination $(1/\sqrt{2\pi})\phi(k) dk$.] Now *this* wave function *can* be normalized [for appropriate $\phi(k)$]. But it necessarily carries a *range* of k 's, and hence a range of energies and speeds. We call it a **wave packet**.

In the generic quantum problem, we are given $\Psi(x, 0)$, and we are to find $\Psi(x, t)$. For a free particle the solution has the form of Equation 2.83; the only remaining question is how to determine $\phi(k)$ so as to fit the initial wave function:

$$\Psi(x, 0) = \frac{1}{\sqrt{2\pi}} \int_{-\infty}^{+\infty} \phi(k) e^{ikx} dk. \quad [2.84]$$

This is a classic problem in Fourier analysis; the answer is provided by **Plancherel's theorem** (see Problem 2.20):

$$f(x) = \frac{1}{\sqrt{2\pi}} \int_{-\infty}^{+\infty} F(k) e^{ikx} dk \iff F(k) = \frac{1}{\sqrt{2\pi}} \int_{-\infty}^{+\infty} f(x) e^{-ikx} dx. \quad [2.85]$$

$F(k)$ is called the **Fourier transform** of $f(x)$; $f(x)$ is the **inverse Fourier transform** of $F(k)$ (the only difference is in the sign of the exponent). There is, of course, some restriction on the allowable functions: The integrals have to *exist*.²² For our purposes this is guaranteed by the physical requirement that $\Psi(x, 0)$ itself be normalized. So the solution to the generic quantum problem, for the free particle, is Equation 2.83, with

$$\phi(k) = \frac{1}{\sqrt{2\pi}} \int_{-\infty}^{+\infty} \Psi(x, 0) e^{-ikx} dx. \quad [2.86]$$

I'd love to work out an example for you—starting with a specific function $\Psi(x, 0)$ for which we could actually calculate $\phi(k)$, and then doing the integral in Equation 2.83 to obtain $\Psi(x, t)$ in closed form. Unfortunately, manageable cases are hard to

²²The necessary and sufficient condition on $f(x)$ is that $\int_{-\infty}^{\infty} |f(x)|^2 dx$ be finite. (In that case $\int_{-\infty}^{\infty} |F(k)|^2 dk$ is also finite, and in fact the two integrals are equal.) See Arfken (footnote 15), Section 15.5.

come by, and I want to save the best example for you to work out yourself. Be sure, therefore, to study Problem 2.22 with particular care.

I return now to the paradox noted earlier—the fact that the separable solution $\Psi_k(x, t)$ travels at the “wrong” speed for the particle it ostensibly represents. Strictly speaking, the problem evaporated when we discovered that Ψ_k is not a physically achievable state. Nevertheless, it is of interest to discover how information about the particle velocity is carried by the wave function (Equation 2.83). The essential idea is this: A wave packet is a sinusoidal function whose amplitude is modulated by ϕ (Figure 2.6); it consists of “ripples” contained within an “envelope.” What corresponds to the particle velocity is not the speed of the individual ripples (the so-called **phase velocity**), but rather the speed of the envelope (the **group velocity**)—which, depending on the nature of the waves, can be greater than, less than, or equal to the velocity of the ripples that go to make it up. For waves on a string, the group velocity is the same as the phase velocity. For water waves it is one half the phase velocity, as you may have noticed when you toss a rock into a pond: If you concentrate on a particular ripple, you will see it build up from the rear, move forward through the group, and fade away at the front, while the group as a whole propagates out at half the speed. What I need to show is that for the wave function of a free particle in quantum mechanics the group velocity is *twice* the phase velocity—just right to represent the classical particle speed.

The problem, then, is to determine the group velocity of a wave packet with the general form

$$\Psi(x, t) = \frac{1}{\sqrt{2\pi}} \int_{-\infty}^{+\infty} \phi(k) e^{i(kx - \omega t)} dk.$$

[In our case $\omega = (\hbar k^2/2m)$, but what I have to say now applies to *any* kind of wave packet, regardless of its **dispersion relation**—the formula for ω as a function of k .] Let us assume that $\phi(k)$ is narrowly peaked about some particular value k_0 . [There is nothing *illegal* about a broad spread in k , but such wave packets change shape rapidly (since different components travel at different speeds), so the whole notion of a “group,” with a well-defined velocity, loses its meaning.] Since the integrand

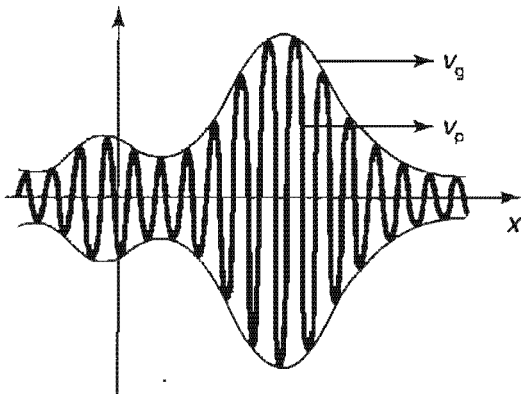

Figure 2.6: A wave packet. The “envelope” travels at the group velocity; the “ripples” travel at the phase velocity.

is negligible except in the vicinity of k_0 , we may as well Taylor-expand the function $\omega(k)$ about that point and keep only the leading terms:

$$\omega(k) \cong \omega_0 + \omega'_0(k - k_0),$$

where ω'_0 is the derivative of ω with respect to k , at the point k_0 .

Changing variables from k to $s \equiv k - k_0$, to center the integral at k_0 , we have

$$\Psi(x, t) \cong \frac{1}{\sqrt{2\pi}} \int_{-\infty}^{+\infty} \phi(k_0 + s) e^{i[(k_0+s)x - (\omega_0 + \omega'_0 s)t]} ds.$$

At $t = 0$,

$$\Psi(x, 0) = \frac{1}{\sqrt{2\pi}} \int_{-\infty}^{+\infty} \phi(k_0 + s) e^{i(k_0+s)x} ds,$$

and at later times

$$\Psi(x, t) \cong \frac{1}{\sqrt{2\pi}} e^{i(-\omega_0 t + k_0 \omega'_0 t)} \int_{-\infty}^{+\infty} \phi(k_0 + s) e^{i(k_0+s)(x - \omega'_0 t)} ds.$$

Except for the shift from x to $(x - \omega'_0 t)$, the integral is the same as the one in $\Psi(x, 0)$. Thus

$$\Psi(x, t) \cong e^{-i(\omega_0 - k_0 \omega'_0)t} \Psi(x - \omega'_0 t, 0). \quad [2.87]$$

Apart from the phase factor in front (which won't affect $|\Psi|^2$ in any event), the wave packet evidently moves along at a speed

$$v_{\text{group}} = \frac{d\omega}{dk} \quad [2.88]$$

(evaluated at $k = k_0$), which is to be contrasted with the ordinary phase velocity

$$v_{\text{phase}} = \frac{\omega}{k}. \quad [2.89]$$

In our case, $\omega = (\hbar k^2/2m)$, so $\omega/k = (\hbar k/2m)$, whereas $d\omega/dk = (\hbar k/m)$, which is twice as great. This confirms that it is the group velocity of the wave packet, not the phase velocity of the stationary states, that matches the classical particle velocity:

$$v_{\text{classical}} = v_{\text{group}} = 2v_{\text{phase}}. \quad [2.90]$$

Problem 2.19 Show that the expressions $[Ae^{ikx} + Be^{-ikx}]$, $[C \cos kx + D \sin kx]$, $[F \cos(kx + \alpha)]$, and $[G \sin(kx + \beta)]$ are equivalent ways of writing the same function of x , and determine the constants C, D, F, G, α , and β in terms of A and B . (In quantum mechanics, with $V = 0$, the exponentials give rise to *traveling* waves, and are most convenient in discussing the free particle, whereas sines and cosines

correspond to *standing* waves, which arise naturally in the case of the infinite square well.) Assume the function is real.

****Problem 2.20** This problem is designed to guide you through a “proof” of Plancherel’s theorem, by starting with the theory of ordinary Fourier series on a *finite* interval, and allowing that interval to expand to infinity.

- (a) Dirichlet’s theorem says that “any” function $f(x)$ on the interval $[-a, +a]$ can be expanded as a Fourier series:

$$f(x) = \sum_{n=0}^{\infty} [a_n \sin(n\pi x/a) + b_n \cos(n\pi x/a)].$$

Show that this can be written equivalently as

$$f(x) = \sum_{n=-\infty}^{\infty} c_n e^{in\pi x/a}.$$

What is c_n , in terms of a_n and b_n ?

- (b) Show (by appropriate modification of Fourier’s trick) that

$$c_n = \frac{1}{2a} \int_{-a}^{+a} f(x) e^{-in\pi x/a} dx.$$

- (c) Eliminate n and c_n in favor of the new variables $k = (n\pi/a)$ and $F(k) = \sqrt{2/\pi} a c_n$. Show that (a) and (b) now become

$$f(x) = \frac{1}{\sqrt{2\pi}} \sum_{n=-\infty}^{\infty} F(k) e^{ikx} \Delta k; \quad F(k) = \frac{1}{\sqrt{2\pi}} \int_{-a}^{+a} f(x) e^{-ikx} dx,$$

where Δk is the increment in k from one n to the next.

- (d) Take the limit $a \rightarrow \infty$ to obtain Plancherel’s theorem. *Note:* In view of their quite different origins, it is surprising (and delightful) that the two formulas [one for $F(k)$ in terms of $f(x)$, the other for $f(x)$ in terms of $F(k)$] have such a similar structure in the limit $a \rightarrow \infty$.

Problem 2.21 Suppose a free particle, which is initially localized in the range $-a < x < a$, is released at time $t = 0$:

$$\Psi(x, 0) = \begin{cases} A, & \text{if } -a < x < a, \\ 0, & \text{otherwise,} \end{cases}$$

where A and a are positive real constants.

- (a) Determine A , by normalizing Ψ .
- (b) Determine $\phi(k)$ (Equation 2.86).
- (c) Comment on the behavior of $\phi(k)$ for very small and very large values of a . How does this relate to the uncertainty principle?

***Problem 2.22** A free particle has the initial wave function

$$\Psi(x, 0) = Ae^{-ax^2},$$

where A and a are constants (a is real and positive).

- (a) Normalize $\Psi(x, 0)$.
- (b) Find $\Psi(x, t)$. *Hint:* Integrals of the form

$$\int_{-\infty}^{+\infty} e^{-(ax^2+bx)} dx$$

can be handled by “completing the square.” Let $y \equiv \sqrt{a}[x + (b/2a)]$, and note that $(ax^2 + bx) = y^2 - (b^2/4a)$. *Answer:*

$$\Psi(x, t) = \left(\frac{2a}{\pi}\right)^{1/4} \frac{e^{-ax^2/[1+(2i\hbar at/m)]}}{\sqrt{1+(2i\hbar at/m)}}.$$

- (c) Find $|\Psi(x, t)|^2$. Express your answer in terms of the quantity $w \equiv \sqrt{a/[1+(2\hbar at/m)^2]}$. Sketch $|\Psi|^2$ (as a function of x) at $t = 0$, and again for some very large t . Qualitatively, what happens to $|\Psi|^2$ as time goes on?
- (d) Find $\langle x \rangle$, $\langle p \rangle$, $\langle x^2 \rangle$, $\langle p^2 \rangle$, σ_x , and σ_p . *Partial answer:* $\langle p^2 \rangle = a\hbar^2$, but it may take some algebra to reduce it to this simple form.
- (e) Does the uncertainty principle hold? At what time t does the system come closest to the uncertainty limit?

2.5 THE DELTA-FUNCTION POTENTIAL

We have encountered two very different kinds of solutions to the time-independent Schrödinger equation: For the infinite square well and the harmonic oscillator they are normalizable, and labeled by a discrete index n ; for the free particle they are non-normalizable, and labeled by a continuous variable k . The former represent physically realizable states in their own right, the latter do not; but in both cases the general solution to the time-dependent Schrödinger equation is a linear combination of stationary states—for the first type this combination takes the form of a sum

(over n), whereas for the second it is an integral (over k). What is the physical significance of this distinction?

In *classical* mechanics a one-dimensional time-independent potential can give rise to two rather different kinds of motion. If $V(x)$ rises higher than the particle's total energy (E) on either side (Figure 2.7a), then the particle is "stuck" in the potential well—it rocks back and forth between the **turning points**, but it cannot escape (unless,

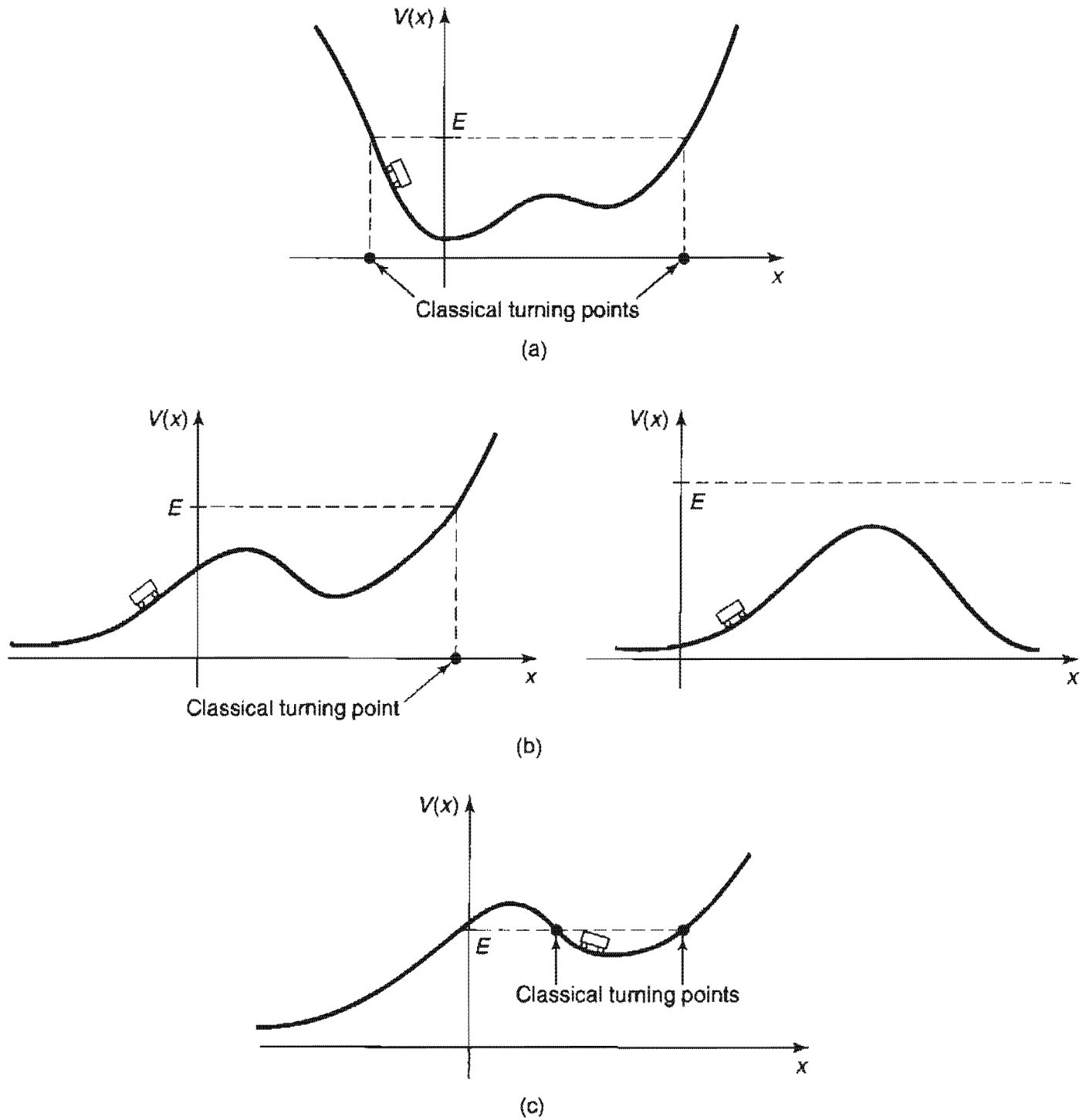

Figure 2.7: (a) A bound state. (b) Scattering states. (c) A classical bound state, but a quantum scattering state.

of course, you provide it with a source of extra energy, such as a motor, but we're not talking about that). We call this a **bound state**. If, on the other hand, E exceeds $V(x)$ on one side (or both), then the particle comes in from "infinity", slows down or speeds up under the influence of the potential, and returns to infinity (Figure 2.7b). (It can't get trapped in the potential unless there is some mechanism, such as friction, to dissipate energy, but again, we're not talking about that.) We call this a **scattering state**. Some potentials admit only bound states (for instance, the harmonic oscillator); some allow only scattering states (a potential hill with no dips in it, for example); some permit both kinds, depending on the energy of the particle.

As you have probably guessed, the two kinds of solutions to the Schrödinger equation correspond precisely to bound and scattering states. The distinction is even cleaner in the quantum domain, because the phenomenon of **tunneling** (which we'll come to shortly) allows the particle to "leak" through any finite potential barrier, so the only thing that matters is the potential at infinity (Figure 2.7c):

$$\begin{cases} E < V(-\infty) \text{ and } V(+\infty) \Rightarrow & \text{bound state,} \\ E > V(-\infty) \text{ or } V(+\infty) \Rightarrow & \text{scattering state.} \end{cases} \quad [2.91]$$

In "real life" most potentials go to zero at infinity, in which case the criterion simplifies even further:

$$\begin{cases} E < 0 \Rightarrow & \text{bound state,} \\ E > 0 \Rightarrow & \text{scattering state.} \end{cases} \quad [2.92]$$

Because the infinite square well and harmonic oscillator potentials go to infinity as $x \rightarrow \pm\infty$, they admit bound states only; because the free particle potential is zero everywhere, it only allows scattering states.²³ In this section (and the following one) we shall explore potentials that give rise to both kinds of states.

The **Dirac delta function**, $\delta(x)$, is defined informally as follows:

$$\delta(x) = \begin{cases} 0, & \text{if } x \neq 0 \\ \infty, & \text{if } x = 0 \end{cases}, \text{ with } \int_{-\infty}^{+\infty} \delta(x) dx = 1. \quad [2.93]$$

It is an infinitely high, infinitesimally narrow spike at the origin, whose *area* is 1 (Figure 2.8). Technically, it's not a function at all, since it is not finite at $x = 0$ (mathematicians call it a **generalized function**, or **distribution**).²⁴ Nevertheless, it is an extremely useful construct in theoretical physics. (For example, in electrodynamics the charge density of a point charge is a delta function.) Notice that $\delta(x - a)$ would

²³If you are very observant, and awfully fastidious, you may have noticed that the general theorem requiring $E > V_{\min}$ (Problem 2.2) does not really apply to scattering states, since they are not normalizable anyway. If this bothers you, try solving the Schrödinger equation with $E < 0$, for the free particle, and note that *even linear combinations* of these solutions cannot be normalized. The positive energy solutions by themselves constitute a complete set.

²⁴The delta function can be thought of as the *limit* of a *sequence* of functions, such as rectangles (or triangles) of ever-increasing height and ever-decreasing width.

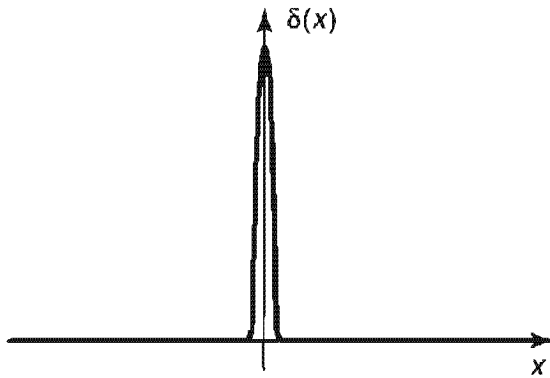

Figure 2.8: The Dirac delta function (Equation 2.93).

be a spike of area 1 at the point a . If you multiply $\delta(x - a)$ by an *ordinary* function $f(x)$, it's the same as multiplying by $f(a)$:

$$f(x)\delta(x - a) = f(a)\delta(x - a), \quad [2.94]$$

because the product is zero *anyway* except at the point a . In particular,

$$\int_{-\infty}^{+\infty} f(x)\delta(x - a) dx = f(a) \int_{-\infty}^{+\infty} \delta(x - a) dx = f(a). \quad [2.95]$$

That's the most important property of the delta function: Under the integral sign it serves to "pick out" the value of $f(x)$ at the point a . (Of course, the integral need not go from $-\infty$ to $+\infty$; all that matters is that the domain of integration include the point a , so $a - \epsilon$ to $a + \epsilon$ would do, for any $\epsilon > 0$.)

Let's consider a potential of the form

$$V(x) = -\alpha\delta(x), \quad [2.96]$$

where α is some constant. This is an artificial potential (so was the infinite square well), but it's beautifully simple and in some respects closer to reality than any of the potentials we have considered so far. The Schrödinger equation reads

$$-\frac{\hbar^2}{2m} \frac{d^2\psi}{dx^2} - \alpha\delta(x)\psi = E\psi. \quad [2.97]$$

This potential yields both bound states ($E < 0$) and scattering states ($E > 0$); we'll look first at the bound states.

In the region $x < 0$, $V(x) = 0$, so

$$\frac{d^2\psi}{dx^2} = -\frac{2mE}{\hbar^2}\psi = \kappa^2\psi, \quad [2.98]$$

where

$$\kappa \equiv \frac{\sqrt{-2mE}}{\hbar}. \quad [2.99]$$

(E is negative, by assumption, so κ is real and positive.) The general solution to Equation 2.98 is

$$\psi(x) = Ae^{-\kappa x} + Be^{\kappa x}, \quad [2.100]$$

but the first term blows up as $x \rightarrow -\infty$, so we must choose $A = 0$:

$$\psi(x) = Be^{\kappa x}, \quad (x < 0). \quad [2.101]$$

In the region $x > 0$, $V(x)$ is again zero, and the general solution is of the form $F \exp(-\kappa x) + G \exp(\kappa x)$; this time it's the second term that blows up (as $x \rightarrow +\infty$), so

$$\psi(x) = Fe^{-\kappa x}, \quad (x > 0). \quad [2.102]$$

It remains only to stitch these two functions together, using the appropriate boundary conditions at $x = 0$. I quoted earlier the standard boundary conditions for ψ :

$$\left\{ \begin{array}{l} 1. \psi \text{ is always continuous, and} \\ 2. d\psi/dx \text{ is continuous except at points} \\ \quad \text{where the potential is infinite.} \end{array} \right. \quad [2.103]$$

In this case the first boundary condition tells us that $F = B$, so

$$\psi(x) = \begin{cases} Be^{\kappa x}, & (x \leq 0), \\ Be^{-\kappa x}, & (x \geq 0). \end{cases} \quad [2.104]$$

[$\psi(x)$ is plotted in Figure 2.9.] The second boundary condition tells us nothing; this is (like the infinite square well) the exceptional case where V is infinite at the join, and it's clear from the graph that this function has a kink at $x = 0$. Moreover, up to this point the delta function has not come into the story at all. Evidently the delta function must determine the discontinuity in the derivative of ψ , at $x = 0$. I'll show you now how this works, and as a byproduct we'll see why $d\psi/dx$ is ordinarily continuous.

The idea is to *integrate* the Schrödinger equation, from $-\epsilon$ to $+\epsilon$, and then take the limit as $\epsilon \rightarrow 0$:

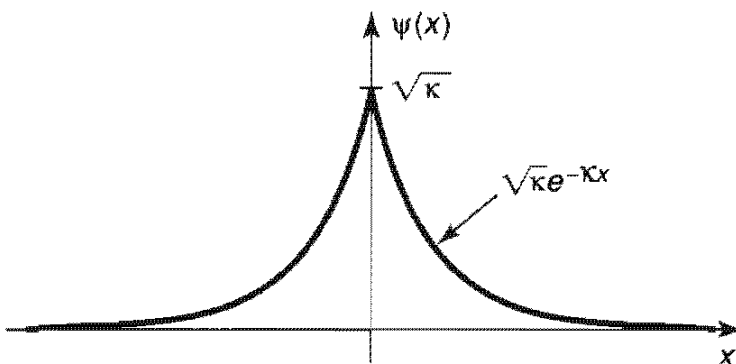

Figure 2.9: Bound state wave function for the delta function potential (Equation 2.104).

$$-\frac{\hbar^2}{2m} \int_{-\epsilon}^{+\epsilon} \frac{d^2\psi}{dx^2} dx + \int_{-\epsilon}^{+\epsilon} V(x)\psi(x) dx = E \int_{-\epsilon}^{+\epsilon} \psi(x) dx. \quad [2.105]$$

The first integral is nothing but $d\psi/dx$, evaluated at the two end points; the last integral is *zero*, in the limit $\epsilon \rightarrow 0$, since it's the area of a sliver with vanishing width and finite height. Thus

$$\Delta \left(\frac{d\psi}{dx} \right) = \frac{2m}{\hbar^2} \lim_{\epsilon \rightarrow 0} \int_{-\epsilon}^{+\epsilon} V(x)\psi(x) dx. \quad [2.106]$$

Ordinarily, the limit on the right is again zero, and hence $d\psi/dx$ is continuous. But when $V(x)$ is *infinite* at the boundary, that argument fails. In particular, if $V(x) = -\alpha\delta(x)$, Equation 2.95 yields

$$\Delta \left(\frac{d\psi}{dx} \right) = -\frac{2m\alpha}{\hbar^2} \psi(0). \quad [2.107]$$

For the case at hand (Equation 2.104),

$$\begin{cases} d\psi/dx = -B\kappa e^{-\kappa x}, & \text{for } (x > 0), & \text{so } d\psi/dx|_+ = -B\kappa, \\ d\psi/dx = +B\kappa e^{+\kappa x}, & \text{for } (x < 0), & \text{so } d\psi/dx|_- = +B\kappa. \end{cases}$$

and hence $\Delta(d\psi/dx) = -2B\kappa$. And $\psi(0) = B$. So Equation 2.107 says

$$\kappa = \frac{m\alpha}{\hbar^2}, \quad [2.108]$$

and the allowed energy (Equation 2.99) is

$$E = -\frac{\hbar^2\kappa^2}{2m} = -\frac{m\alpha^2}{2\hbar^2}. \quad [2.109]$$

Finally, we normalize ψ :

$$\int_{-\infty}^{+\infty} |\psi(x)|^2 dx = 2|B|^2 \int_0^{\infty} e^{-2\kappa x} dx = \frac{|B|^2}{\kappa} = 1,$$

so (choosing, for convenience, the positive real root):

$$B = \sqrt{\kappa} = \frac{\sqrt{m\alpha}}{\hbar}. \quad [2.110]$$

Evidently the delta-function well, regardless of its "strength" α , has exactly one bound state:

$$\psi(x) = \frac{\sqrt{m\alpha}}{\hbar} e^{-m\alpha|x|/\hbar^2}; \quad E = -\frac{m\alpha^2}{2\hbar^2}. \quad [2.111]$$

What about scattering states, with $E > 0$? For $x < 0$ the Schrödinger equation reads

$$\frac{d^2\psi}{dx^2} = -\frac{2mE}{\hbar^2}\psi = -k^2\psi,$$

where

$$k \equiv \frac{\sqrt{2mE}}{\hbar} \quad [2.112]$$

is real and positive. The general solution is

$$\psi(x) = Ae^{ikx} + Be^{-ikx}, \quad [2.113]$$

and this time we cannot rule out either term, since neither of them blows up. Similarly, for $x > 0$,

$$\psi(x) = Fe^{ikx} + Ge^{-ikx}. \quad [2.114]$$

The continuity of $\psi(x)$ at $x = 0$ requires that

$$F + G = A + B. \quad [2.115]$$

The derivatives are

$$\begin{cases} d\psi/dx = ik(Fe^{ikx} - Ge^{-ikx}), & \text{for } (x > 0), & \text{so } d\psi/dx|_+ = ik(F - G), \\ d\psi/dx = ik(Ae^{ikx} - Be^{-ikx}), & \text{for } (x < 0), & \text{so } d\psi/dx|_- = ik(A - B), \end{cases}$$

and hence $\Delta(d\psi/dx) = ik(F - G - A + B)$. Meanwhile, $\psi(0) = (A + B)$, so the second boundary condition (Equation 2.107) says

$$ik(F - G - A + B) = -\frac{2m\alpha}{\hbar^2}(A + B), \quad [2.116]$$

or, more compactly,

$$F - G = A(1 + 2i\beta) - B(1 - 2i\beta), \quad \text{where } \beta \equiv \frac{m\alpha}{\hbar^2 k}. \quad [2.117]$$

Having imposed the boundary conditions, we are left with two equations (Equations 2.115 and 2.117) in four unknowns (A , B , F , and G)—*five*, if you count k . Normalization won't help—this isn't a normalizable state. Perhaps we'd better pause, then, and examine the physical significance of these various constants. Recall that $\exp(ikx)$ gives rise [when coupled with the time-dependent factor $\exp(-iEt/\hbar)$] to a wave function propagating to the *right*, and $\exp(-ikx)$ leads to a wave propagating to the *left*. It follows that A (in Equation 2.113) is the amplitude of a wave coming in from the left, B is the amplitude of a wave returning to the left, F (in Equation 2.114) is the amplitude of a wave traveling off to the right, and G is the amplitude of a wave coming in from the right (Figure 2.10). In a typical scattering experiment particles are fired in from one direction—let's say, from the left. In that case the amplitude of the wave coming in from the *right* will be zero:

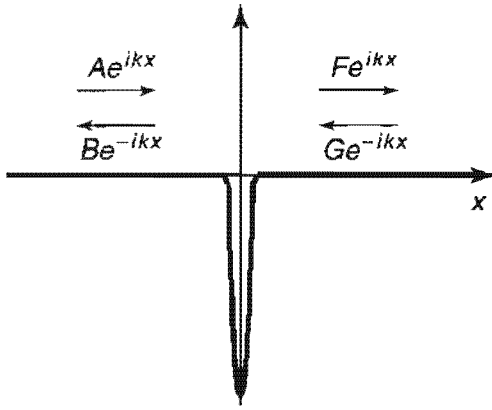

Figure 2.10: Scattering from a delta-function well.

$$G = 0 \quad (\text{for scattering from the left}). \quad [2.118]$$

A is then the amplitude of the **incident wave**, B is the amplitude of the **reflected wave**, and F is the amplitude of the **transmitted wave**. Solving Equations 2.115 and 2.117 for B and F , we find

$$B = \frac{i\beta}{1 - i\beta} A, \quad F = \frac{1}{1 - i\beta} A. \quad [2.119]$$

(If you want to study scattering from the *right*, set $A = 0$; then G is the incident amplitude, F is the reflected amplitude, and B is the transmitted amplitude.)

Now, the probability of finding the particle at a specified location is given by $|\Psi|^2$, so the *relative*²⁵ probability that an incident particle will be reflected back is

$$R \equiv \frac{|B|^2}{|A|^2} = \frac{\beta^2}{1 + \beta^2}. \quad [2.120]$$

R is called the **reflection coefficient**. (If you have a *beam* of particles, it tells you the *fraction* of the incoming number that will bounce back.) Meanwhile, the probability of transmission is given by the **transmission coefficient**

$$T \equiv \frac{|F|^2}{|A|^2} = \frac{1}{1 + \beta^2}. \quad [2.121]$$

Of course, the sum of these probabilities should be 1—and it *is*:

$$R + T = 1. \quad [2.122]$$

Notice that R and T are functions of β , and hence (Equations 2.112 and 2.117) of E :

$$R = \frac{1}{1 + (2\hbar^2 E / m\alpha^2)}, \quad T = \frac{1}{1 + (m\alpha^2 / 2\hbar^2 E)}. \quad [2.123]$$

²⁵This is not a normalizable wave function, so the *absolute* probability of finding the particle at a particular location is not well defined; nevertheless, the *ratio* of probabilities for two different locations is meaningful. More on this in the next paragraph.

The higher the energy, the greater the probability of transmission (which seems reasonable).

This is all very tidy, but there is a sticky matter of principle that we cannot altogether ignore: These scattering wave functions are not normalizable, so they don't actually represent possible particle states. But we know what the resolution to this problem is: We must form normalizable linear combinations of the stationary states, just as we did for the free particle—true physical particles are represented by the resulting wave packets. Though straightforward in principle, this is a messy business in practice, and at this point it is best to turn the problem over to a computer.²⁶ Meanwhile, since it is impossible to create a normalizable free particle wave function without involving a range of energies, R and T should be interpreted as the *approximate* reflection and transmission probabilities for particles in a narrow energy range about E . Incidentally, it might strike you as peculiar that we were able to analyse a quintessentially time-dependent problem (particle comes in, scatters off a potential, and flies off to infinity) using *stationary* states. After all, ψ (in Equations 2.113 and 2.114) is simply a complex, time-independent, sinusoidal function, extending (with constant amplitude) to infinity in both directions. And yet, by imposing appropriate boundary conditions on this function, we were able to determine the probability that a particle (represented by a *localized* wave packet) would bounce off, or pass through, the potential. The mathematical miracle behind this is, I suppose, the fact that by taking linear combinations of states spread over all space, and with essentially trivial time dependence, we can *construct* wave functions that are concentrated about a (moving) point, with quite elaborate behavior in time (see Problem 2.40).

As long as we've got the relevant equations on the table, let's look briefly at the case of a delta-function *barrier* (Figure 2.11). Formally, all we have to do is change the sign of α . This kills the bound state, of course (see Problem 2.2). On the other hand, the reflection and transmission coefficients, which depend only on α^2 , are unchanged. Strange to say, the particle is just as likely to pass through the barrier as to cross over the well! *Classically*, of course, the particle could not make it over an infinitely high barrier, regardless of its energy. In fact, the classical scattering

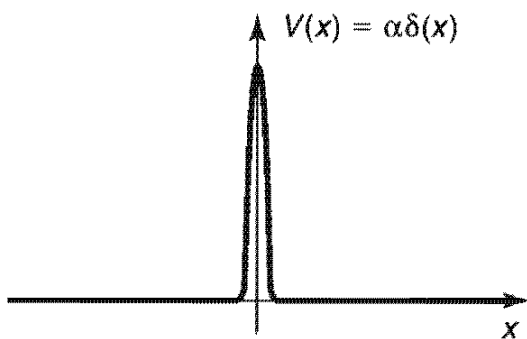

Figure 2.11: The delta-function barrier.

²⁶There exist some powerful programs for analysing the scattering of a wave packet from a one-dimensional potential; see, for instance, A. Goldberg, H. M. Schey, and J. L. Schwartz, *Am. J. Phys.* **35**, 177 (1967).

problem is pretty dull: If $E > V_{\max}$, then $T = 1$ and $R = 0$ —the particle certainly makes it over; conversely, if $E < V_{\max}$, then $T = 0$ and $R = 1$ —it rides “up the hill” until it runs out of energy, and then returns the same way it came. The *quantum* scattering problem is much richer; the particle has some nonzero probability of passing through the potential even if $E < V_{\max}$. We call this phenomenon **tunneling**; it is the mechanism that makes possible much of modern electronics—not to mention spectacular recent advances in microscopy. Conversely, even if $E > V_{\max}$, there is a possibility that the particle will bounce back—though I wouldn’t advise driving off a cliff in the expectation that quantum mechanics will save you (see Problem 2.41).

Problem 2.23 Evaluate the following integrals:

- (a) $\int_{-3}^{+1} (x^3 - 3x^2 + 2x - 1)\delta(x + 2) dx$
- (b) $\int_0^{\infty} [\cos(3x) + 2]\delta(x - \pi) dx$
- (c) $\int_{-1}^{+1} \exp(|x| + 3)\delta(x - 2) dx.$

Problem 2.24 Two expressions $\{D_1(x)$ and $D_2(x)\}$ involving delta functions are said to be equal if

$$\int_{-\infty}^{+\infty} f(x)D_1(x) dx = \int_{-\infty}^{+\infty} f(x)D_2(x) dx,$$

for any (ordinary) function $f(x)$.

- (a) Show that

$$\delta(cx) = \frac{1}{|c|}\delta(x), \tag{2.124}$$

where c is a real constant.

- (b) Let $\theta(x)$ be the **step function**:

$$\theta(x) \equiv \begin{cases} 1, & \text{if } x > 0, \\ 0, & \text{if } x < 0. \end{cases} \tag{2.125}$$

[In the rare case where it actually matters, we define $\theta(0)$ to be $1/2$.] Show that $d\theta/dx = \delta(x)$.

***Problem 2.25** What is the Fourier transform of $\delta(x)$? Using Plancherel’s theorem, show that

$$\delta(x) = \frac{1}{2\pi} \int_{-\infty}^{+\infty} e^{ikx} dk. \tag{2.126}$$

Comment: This formula gives any respectable mathematician apoplexy. Although the integral is clearly infinite when $x = 0$, it doesn’t converge (to zero or anything else) when $x \neq 0$, since the integrand oscillates forever. There are ways to patch it up

(for instance, you can integrate from $-L$ to $+L$, and interpret the integral in Equation 2.126 to mean the *average* value of the finite integral, as $L \rightarrow \infty$). The source of the problem is that the delta function doesn't meet the requirement (square integrability) for Plancherel's theorem (see footnote 22). In spite of this, Equation 2.126 can be extremely useful, if handled with care.

***Problem 2.26** Consider the *double* delta-function potential

$$V(x) = -\alpha[\delta(x + a) + \delta(x - a)],$$

where α and a are positive constants.

(a) Sketch this potential.

(b) How many bound states does it possess? Find the allowed energies, for $\alpha = \hbar^2/ma$ and for $\alpha = \hbar^2/4ma$, and sketch the wave functions.

****Problem 2.27** Find the transmission coefficient for the potential in Problem 2.26.

2.6 THE FINITE SQUARE WELL

As a last example, consider the finite square well

$$V(x) = \begin{cases} -V_0, & \text{for } -a < x < a, \\ 0, & \text{for } |x| > a, \end{cases} \quad [2.127]$$

where V_0 is a (positive) constant (Figure 2.12). Like the delta-function well, the finite square well admits both bound states (with $E < 0$) and scattering states (with $E > 0$). We'll look first at the bound states.

In the region $x < -a$ the potential is zero, so the Schrödinger equation reads

$$-\frac{\hbar^2}{2m} \frac{d^2\psi}{dx^2} = E\psi, \quad \text{or} \quad \frac{d^2\psi}{dx^2} = \kappa^2\psi,$$

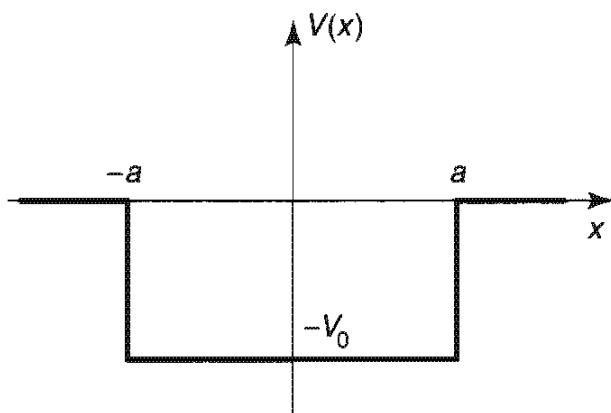

Figure 2.12: The finite square well (Equation 2.127).

where

$$\kappa \equiv \frac{\sqrt{-2mE}}{\hbar} \quad [2.128]$$

is real and positive. The general solution is $\psi(x) = A \exp(-\kappa x) + B \exp(\kappa x)$, but the first term blows up (as $x \rightarrow -\infty$), so the physically admissible solution (as before—see Equation 2.101) is

$$\psi(x) = B e^{\kappa x}, \quad \text{for } (x < -a). \quad [2.129]$$

In the region $-a < x < a$, $V(x) = -V_0$, and the Schrödinger equation reads

$$-\frac{\hbar^2}{2m} \frac{d^2\psi}{dx^2} - V_0\psi = E\psi, \quad \text{or } \frac{d^2\psi}{dx^2} = -l^2\psi,$$

where

$$l \equiv \frac{\sqrt{2m(E + V_0)}}{\hbar}. \quad [2.130]$$

Although E is negative, for a bound state, it must be greater than $-V_0$, by the old theorem $E > V_{\min}$ (Problem 2.2); so l is also real and positive. The general solution is

$$\psi(x) = C \sin(lx) + D \cos(lx), \quad \text{for } (-a < x < a), \quad [2.131]$$

where C and D are arbitrary constants. Finally, in the region $x > a$ the potential is again zero; the general solution is $\psi(x) = F \exp(-\kappa x) + G \exp(\kappa x)$, but the second term blows up (as $x \rightarrow \infty$), so we are left with

$$\psi(x) = F e^{-\kappa x}, \quad \text{for } (x > a). \quad [2.132]$$

The next step is to impose boundary conditions: ψ and $d\psi/dx$ continuous at $-a$ and $+a$. But we can save a little time by noting that this potential is an even function, so we can assume with no loss of generality that the solutions are either even or odd (Problem 2.1c). The advantage of this is that we need only impose the boundary conditions on one side (say, at $+a$); the other side is then automatic, since $\psi(-x) = \pm\psi(x)$. I'll work out the even solutions; you get to do the odd ones in Problem 2.28. The cosine is even (and the sine is odd), so I'm looking for solutions of the form

$$\psi(x) = \begin{cases} F e^{-\kappa x}, & \text{for } (x > a), \\ D \cos(lx), & \text{for } (0 < x < a), \\ \psi(-x), & \text{for } (x < 0). \end{cases} \quad [2.133]$$

The continuity of $\psi(x)$, at $x = a$, says

$$F e^{-\kappa a} = D \cos(la), \quad [2.134]$$

and the continuity of $d\psi/dx$ says

$$-\kappa F e^{-\kappa a} = -l D \sin(la). \quad [2.135]$$

Dividing Equation 2.135 by Equation 2.134, we find that

$$\kappa = l \tan(la). \quad [2.136]$$

Equation 2.136 is a formula for the allowed energies, since κ and l are both functions of E . To solve for E , it pays to adopt some nicer notation. Let

$$z \equiv la, \quad \text{and} \quad z_0 \equiv \frac{a}{\hbar} \sqrt{2mV_0}. \quad [2.137]$$

According to Equations 2.128 and 2.130, $(\kappa^2 + l^2) = 2mV_0/\hbar^2$, so $\kappa a = \sqrt{z_0^2 - z^2}$, and Equation 2.136 reads

$$\tan z = \sqrt{(z_0/z)^2 - 1}. \quad [2.138]$$

This is a transcendental equation for z (and hence for E) as a function of z_0 (which is a measure of the “size” of the well). It can be solved numerically, using a calculator or a computer, or graphically, by plotting $\tan z$ and $\sqrt{(z_0/z)^2 - 1}$ on the same grid, and looking for points of intersection (see Figure 2.13). Two limiting cases are of special interest:

1. Wide, deep well. If z_0 is very large, the intersections occur just slightly below $z_n = n\pi/2$, with n odd; it follows that

$$E_n + V_0 \cong \frac{n^2 \pi^2 \hbar^2}{2m(2a)^2}. \quad [2.139]$$

Here $(E + V_0)$ is the energy above the bottom of the well, and on the right we have precisely the infinite square well energies, for a well of width $2a$ (see Equation 2.23)—or rather, *half* of them, since n is odd. (The other ones, of course, come from the *odd* wave functions, as you’ll find in Problem 2.28.) So the finite square well goes over to the infinite square well, as $V_0 \rightarrow \infty$; however, for any *finite* V_0 there are only finitely many bound states.

2. Shallow, narrow well. As z_0 decreases, there are fewer and fewer bound states, until finally (for $z_0 < \pi/2$, where the lowest *odd* state disappears) only one remains. It is interesting to note, however, that there is always *one* bound state, no matter how “weak” the well becomes.

You’re welcome to normalize ψ (Equation 2.133), if you’re interested (see Problem 2.29), but I’m going to move on now to the scattering states ($E > 0$). To the left, where $V(x) = 0$, we have

$$\psi(x) = Ae^{ikx} + Be^{-ikx}, \quad \text{for } (x < -a), \quad [2.140]$$

where (as usual)

$$k \equiv \frac{\sqrt{2mE}}{\hbar}. \quad [2.141]$$

Inside the well, where $V(x) = -V_0$,

$$\psi(x) = C \sin(lx) + D \cos(lx), \quad \text{for } (-a < x < a), \quad [2.142]$$

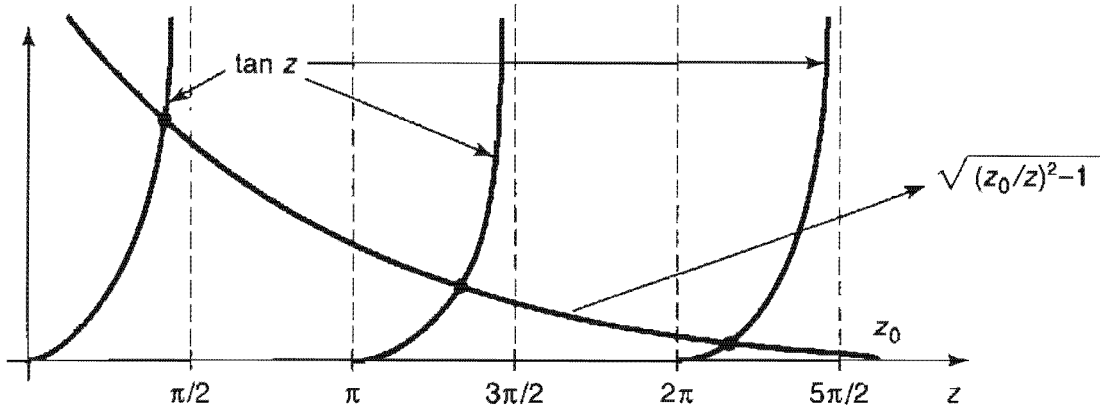

Figure 2.13: Graphical solution to Equation 2.138, for $z_0 = 8$ (even states).

where, as before,

$$l \equiv \frac{\sqrt{2m(E + V_0)}}{\hbar}. \quad [2.143]$$

To the right, assuming there is no incoming wave in this region, we have

$$\psi(x) = F e^{ikx}. \quad [2.144]$$

A is the incident amplitude, B is the reflected amplitude, and F is the transmitted amplitude.²⁷

There are four boundary conditions: Continuity of $\psi(x)$ at $-a$ says

$$A e^{-ika} + B e^{ika} = -C \sin(la) + D \cos(la), \quad [2.145]$$

continuity of $d\psi/dx$ at $-a$ gives

$$ik[A e^{-ika} - B e^{ika}] = l[C \cos(la) + D \sin(la)], \quad [2.146]$$

continuity of $\psi(x)$ at $+a$ yields

$$C \sin(la) + D \cos(la) = F e^{ika}, \quad [2.147]$$

and continuity of $d\psi/dx$ at $+a$ requires

$$l[C \cos(la) - D \sin(la)] = ikF e^{ika}, \quad [2.148]$$

We can use two of these to eliminate C and D , and solve the remaining two for B and F (see Problem 2.31):

$$B = i \frac{\sin(2la)}{2kl} (l^2 - k^2) F, \quad [2.149]$$

²⁷We could use even and odd functions, as we did for bound states, but these would represent standing waves, and the scattering problem is more naturally formulated in terms of traveling waves.

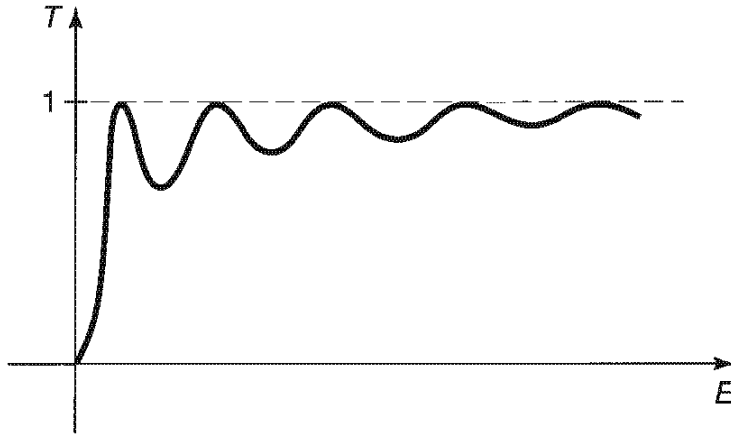

Figure 2.14: Transmission coefficient as a function of energy (Equation 2.151).

$$F = \frac{e^{-2ika} A}{\cos(2la) - i \frac{\sin(2la)}{2kl} (k^2 + l^2)}. \quad [2.150]$$

The transmission coefficient ($T = |F|^2/|A|^2$), expressed in terms of the original variables, is given by

$$T^{-1} = 1 + \frac{V_0^2}{4E(E + V_0)} \sin^2 \left(\frac{2a}{\hbar} \sqrt{2m(E + V_0)} \right). \quad [2.151]$$

Notice that $T = 1$ (the well becomes “transparent”) whenever the argument of the sine is zero, which is to say, for

$$\frac{2a}{\hbar} \sqrt{2m(E_n + V_0)} = n\pi, \quad [2.152]$$

where n is any integer. The energies for perfect transmission, then, are given by

$$E_n + V_0 = \frac{n^2 \pi^2 \hbar^2}{2m(2a)^2}, \quad [2.153]$$

which happen to be precisely the allowed energies for the infinite square well. T is plotted in Figure 2.14 as a function of energy.

***Problem 2.28** Analyze the *odd* bound-state wave functions for the finite square well. Derive the transcendental equation for the allowed energies, and solve it graphically. Examine the two limiting cases. Is there always at least one odd bound state?

Problem 2.29 Normalize $\psi(x)$ in Equation 2.133 to determine the constants D and F .

Problem 2.30 The Dirac delta function can be thought of as the limiting case of a rectangle of area 1, as the height goes to infinity and the width goes to zero. Show that the delta-function well (Equation 2.96) is a “weak” potential (even though it is

infinitely deep), in the sense that $z_0 \rightarrow 0$. Determine the bound-state energy for the delta-function potential, by treating it as the limit of a finite square well. Check that your answer is consistent with Equation 2.111. Also show that Equation 2.151 reduces to Equation 2.123 in the appropriate limit.

***Problem 2.31** Derive Equations 2.149 and 2.150. *Hint:* Use Equations 2.147 and 2.148 to solve for C and D in terms of F :

$$C = \left[\sin(la) + i \frac{k}{l} \cos(la) \right] e^{ika} F; \quad D = \left[\cos(la) - i \frac{k}{l} \sin(la) \right] e^{ika} F.$$

Plug these back into Equations 2.145 and 2.146. Obtain the transmission coefficient, and confirm Equation 2.151. Work out the reflection coefficient, and check that $T + R = 1$.

****Problem 2.32** Determine the transmission coefficient for a rectangular *barrier* (same as Equation 2.127, only with $+V_0$ in the region $-a < x < a$). Treat separately the three cases $E < V_0$, $E = V_0$, and $E > V_0$ (note that the wave function inside the barrier is different in the three cases). *Partial answer:* For $E < V_0$,²⁸

$$T^{-1} = 1 + \frac{V_0^2}{4E(V_0 - E)} \sinh^2 \left(\frac{2a}{\hbar} \sqrt{2m(V_0 - E)} \right).$$

****Problem 2.33** Consider the step function potential:

$$V(x) = \begin{cases} 0, & \text{if } x \leq 0, \\ V_0, & \text{if } x > 0. \end{cases}$$

- Calculate the reflection coefficient, for the case $E < V_0$, and comment on the answer.
- Calculate the reflection coefficient for the case $E > V_0$.
- For a potential such as this that does not go back to zero to the right of the barrier, the transmission coefficient is *not* simply $|F|^2/|A|^2$, with A the incident amplitude and F the transmitted amplitude, because the transmitted wave travels at a different *speed*. Show that

$$T = \sqrt{\frac{E - V_0}{E}} \frac{|F|^2}{|A|^2}, \quad [2.154]$$

for $E > V_0$. *Hint:* You can figure it out using Equation 2.81, or—more elegantly, but less informatively—from the probability current (Problem 1.9a). What is T for $E < V_0$?

²⁸This is a good example of tunneling—*classically* the particle would bounce back.

- (d) For $E > V_0$, calculate the transmission coefficient for the step potential, and check that $T + R = 1$.

2.7 THE SCATTERING MATRIX

The theory of scattering generalizes in a pretty obvious way to arbitrary localized potentials (Figure 2.15). To the left (Region I), $V(x) = 0$, so

$$\psi(x) = Ae^{ikx} + Be^{-ikx}, \quad \text{where } k \equiv \frac{\sqrt{2mE}}{\hbar}. \quad [2.155]$$

To the right (Region III), $V(x)$ is again zero, so

$$\psi(x) = Fe^{ikx} + Ge^{-ikx}. \quad [2.156]$$

In between (Region II), of course, I can't tell you what ψ is until you specify the potential, but because the Schrödinger equation is a linear, second-order differential equation, the general solution has got to be of the form

$$\psi(x) = Cf(x) + Dg(x), \quad [2.157]$$

where $f(x)$ and $g(x)$ are any two linearly independent particular solutions.²⁹ There will be four boundary conditions (two joining Regions I and II, and two joining Regions II and III). Two of these can be used to eliminate C and D , and the other two can be “solved” for B and F in terms of A and G :

$$B = S_{11}A + S_{12}G, \quad F = S_{21}A + S_{22}G. \quad [2.158]$$

The four coefficients S_{ij} , which depend on k (and hence on E), constitute a 2×2 matrix

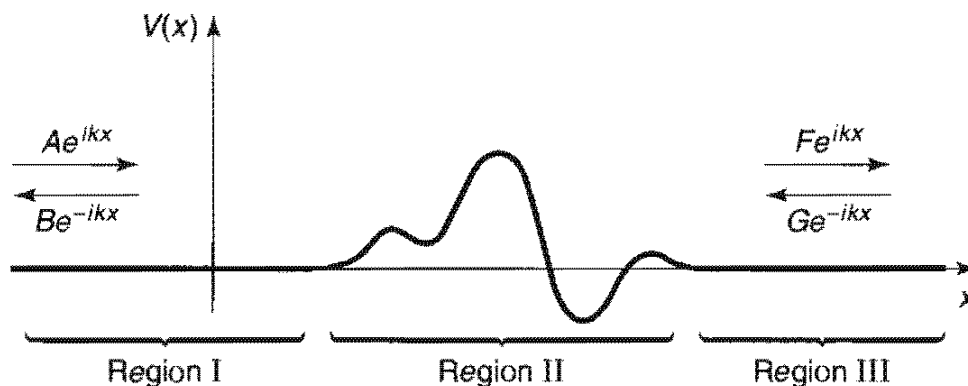

Figure 2.15: Scattering from an arbitrary localized potential [$V(x) = 0$ except in Region II].

²⁹See any book on differential equations—for example, J. L. Van Iwaarden, *Ordinary Differential Equations with Numerical Techniques* (San Diego, CA: Harcourt Brace Jovanovich, 1985), Chapter 3.

$$\mathbf{S} = \begin{pmatrix} S_{11} & S_{12} \\ S_{21} & S_{22} \end{pmatrix}, \quad [2.159]$$

called the **scattering matrix** (or **S-matrix**, for short). The S -matrix tells you the outgoing amplitudes (B and F) in terms of the incoming amplitudes (A and G):

$$\begin{pmatrix} B \\ F \end{pmatrix} = \mathbf{S} \begin{pmatrix} A \\ G \end{pmatrix}. \quad [2.160]$$

In the typical case of scattering from the left, $G = 0$, so the reflection and transmission coefficients are

$$R_l = \frac{|B|^2}{|A|^2} \Big|_{G=0} = |S_{11}|^2, \quad T_l = \frac{|F|^2}{|A|^2} \Big|_{G=0} = |S_{21}|^2. \quad [2.161]$$

For scattering from the right, $A = 0$, and

$$R_r = \frac{|F|^2}{|G|^2} \Big|_{A=0} = |S_{22}|^2, \quad T_r = \frac{|B|^2}{|G|^2} \Big|_{A=0} = |S_{12}|^2. \quad [2.162]$$

The S -matrix tells you everything there is to know about scattering from a localized potential. Surprisingly, it *also* contains (albeit in a concealed form) information about the bound states (if there *are* any). For if $E < 0$, then $\psi(x)$ has the form

$$\psi(x) = \begin{cases} B e^{\kappa x} & \text{(Region I),} \\ C f(x) + D g(x) & \text{(Region II),} \\ F e^{-\kappa x} & \text{(Region III),} \end{cases} \quad [2.163]$$

with

$$\kappa \equiv \frac{\sqrt{-2mE}}{\hbar}. \quad [2.164]$$

The boundary conditions are the same as before, so the S -matrix has the same structure—only now E is *negative*, so $k \rightarrow i\kappa$. But this time A and G are necessarily zero, whereas B and F are not, and hence (Equation 2.158) at least two elements in the S -matrix must be infinite. To put it the other way around, if you've got the S -matrix (for $E > 0$), and you want to locate the bound states, put in $k \rightarrow i\kappa$, and look for energies at which the S -matrix blows up.

For example, in the case of the finite square well,

$$S_{21} = \frac{e^{-2ika}}{\cos(2la) - i \frac{\sin(2la)}{2kl} (k^2 + l^2)}$$

(Equation 2.150). Substituting $k \rightarrow i\kappa$, we see that S_{21} blows up whenever

$$\cot(2la) = \frac{l^2 - \kappa^2}{2\kappa l}.$$

Using the trigonometric identity

$$\tan\left(\frac{\theta}{2}\right) = \pm\sqrt{1 + \cot^2\theta} - \cot\theta,$$

we obtain

$$\tan(la) = \frac{l}{\kappa} \text{ (plus sign), and } \cot(la) = -\frac{\kappa}{l} \text{ (minus sign).}$$

These are precisely the conditions for bound states of the finite square well (Equation 2.136 and Problem 2.28).

***Problem 2.34** Construct the S -matrix for scattering from a delta-function well (Equation 2.96). Use it to obtain the bound state energy, and check your answer against Equation 2.111.

Problem 2.35 Find the S -matrix for the finite square well (Equation 2.127). *Hint:* This requires no new work if you carefully exploit the symmetry of the problem.

FURTHER PROBLEMS FOR CHAPTER 2

Problem 2.36 A particle in the infinite square well (Equation 2.15) has the initial wave function

$$\Psi(x, 0) = A \sin^3(\pi x/a).$$

Find $\langle x \rangle$ as a function of time.

***Problem 2.37** Find $\langle x \rangle$, $\langle p \rangle$, $\langle x^2 \rangle$, $\langle p^2 \rangle$, $\langle T \rangle$, and $\langle V(x) \rangle$ for the n th stationary state of the harmonic oscillator. Check that the uncertainty principle is satisfied. *Hint:* Express x and $(\hbar/i)(d/dx)$ in terms of $(a_+ \pm a_-)$, and use Equations 2.52 and 2.53; you may assume that the states are orthogonal.

Problem 2.38 Find the allowed energies of the half-harmonic oscillator

$$V(x) = \begin{cases} (1/2)m\omega^2x^2, & \text{for } (x > 0), \\ \infty, & \text{for } (x < 0). \end{cases}$$

(This represents, for example, a spring that can be stretched, but not compressed.)

Hint: This requires some careful thought, but very little actual computation.

****Problem 2.39** Solve the time-independent Schrödinger equation for an infinite square well with a delta-function barrier at the center:

$$V(x) = \begin{cases} \alpha\delta(x), & \text{for } (-a < x < +a), \\ \infty, & \text{for } (|x| \geq a). \end{cases}$$

Treat the even and odd wave functions separately. Don't bother to normalize them. Find the allowed energies (graphically, if necessary). How do they compare with the corresponding energies in the absence of the delta function? Comment on the limiting cases $\alpha \rightarrow 0$ and $\alpha \rightarrow \infty$.

****Problem 2.40** In Problem 2.22 you analyzed the *stationary* Gaussian free particle wave packet. Now solve the same problem for the *traveling* Gaussian wave packet, starting with the initial wave function

$$\Psi(x, 0) = Ae^{-ax^2} e^{ilx},$$

where l is a real constant.

Problem 2.41 A particle of mass m and kinetic energy $E > 0$ approaches an abrupt potential drop V_0 (Figure 2.16).

- What is the probability that it will “reflect” back, if $E = V_0/3$?
- I drew the figure so as to make you think of a car approaching a cliff, but obviously the probability of “bouncing back” from the edge of a cliff is *far* smaller than what you got in (a)—unless you're Bugs Bunny. Explain why this potential does *not* correctly represent a cliff.

Problem 2.42 If two (or more) distinct³⁰ solutions to the (time-independent) Schrödinger equation have the same energy E , these states are said to be **degenerate**. For example, the free particle states are doubly degenerate—one solution representing motion to the right, and the other motion to the left. But we have encountered no

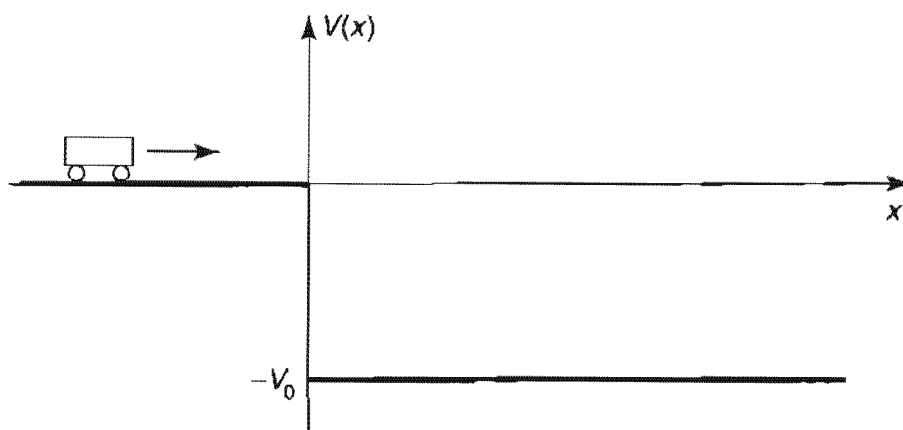

Figure 2.16: Scattering from a “cliff” (Problem 2.41).

³⁰If the two solutions differ only by a multiplicative constant (so that, once normalized, they differ only by a phase factor $e^{i\phi}$), they represent the same physical state, and in this case they are not distinct solutions. Technically, by “distinct” I mean “linearly independent.”

normalizable degenerate solutions, and this is not an accident. Prove the following theorem: In one dimension³¹ there are no degenerate bound states. *Hint:* Suppose there are two solutions, ψ_1 and ψ_2 , with the same energy E . Multiply the Schrödinger equation for ψ_1 by ψ_2 , and the Schrödinger equation for ψ_2 by ψ_1 , and subtract, to show that $(\psi_2 d\psi_1/dx - \psi_1 d\psi_2/dx)$ is a constant. Use the fact that for normalizable solutions $\psi \rightarrow 0$ at $\pm\infty$ to demonstrate that this constant is in fact zero. Conclude that ψ_2 is a multiple of ψ_1 , and hence that the two solutions are not distinct.

Problem 2.43 Imagine a bead of mass m that slides frictionlessly around a circular wire ring of circumference a . [This is just like a free particle, except that $\psi(x) = \psi(x + a)$.] Find the stationary states (with appropriate normalization) and the corresponding allowed energies. Note that there are *two* independent solutions for each energy E_n —corresponding to clockwise and counterclockwise circulation; call them $\psi_n^+(x)$ and $\psi_n^-(x)$. How do you account for this degeneracy, in view of the theorem in Problem 2.42—that is, why does the theorem fail in this case?

****Problem 2.44** (*Attention:* This is a strictly qualitative problem—no calculations allowed!) Consider the “double square well” potential (Figure 2.17). Suppose the depth V_0 and the width a are fixed, and great enough so that several bound states occur.

- Sketch the ground-state wave function ψ_1 and the first excited state ψ_2 , (i) for the case $b = 0$, (ii) for $b \approx a$, and (iii) for $b \gg a$.
- Qualitatively, how do the corresponding energies (E_1 and E_2) vary, as b goes from 0 to ∞ ? Sketch $E_1(b)$ and $E_2(b)$ on the same graph.
- The double well is a very primitive one-dimensional model for the potential experienced by an electron in a diatomic molecule (the two wells represent the attractive force of the nuclei). If the nuclei are free to move, they will adopt the configuration of minimum energy. In view of your conclusions in (b), does the electron tend to draw the nuclei together, or push them apart? (Of course, there is also the internuclear repulsion to consider, but that’s a separate problem.)

*****Problem 2.45**

- Show that

$$\Psi(x, t) = \left(\frac{m\omega}{\pi\hbar}\right)^{1/4} \exp\left[-\frac{m\omega}{2\hbar}\left(x^2 + \frac{a^2}{2}(1 + e^{-2i\omega t}) + \frac{i\hbar t}{m} - 2axe^{-i\omega t}\right)\right]$$

³¹In higher dimensions such degeneracy is very common, as we shall see in Chapter 4. Assume that the potential does not consist of isolated pieces separated by regions where $V = \infty$ —two isolated infinite square wells, for instance, would give rise to degenerate bound states, for which the particle is either in the one or in the other.

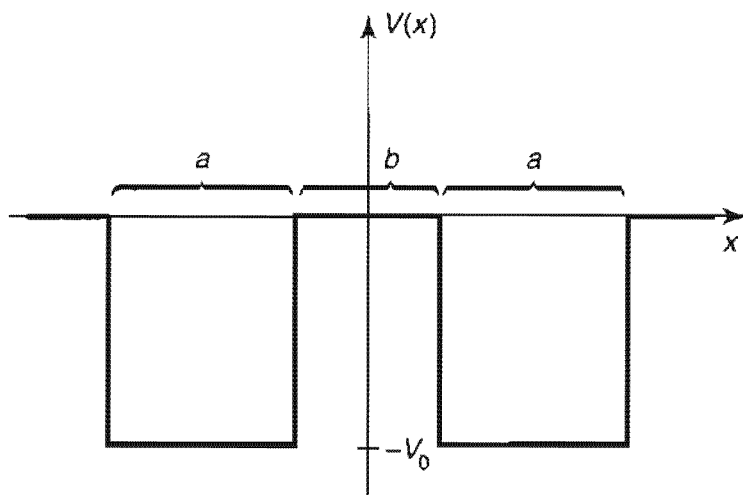

Figure 2.17: The double square well (Problem 2.44).

satisfies the time-*dependent* Schrödinger equation for the harmonic oscillator potential (Equation 2.38). Here a is any real constant (with the dimensions of length).³²

- (b) Find $|\Psi(x, t)|^2$, and describe the motion of the wave packet.
- (c) Compute $\langle x \rangle$ and $\langle p \rangle$, and check that Ehrenfest's theorem (Equation 1.38) is satisfied.

Problem 2.46 Consider the potential

$$V(x) = \begin{cases} \infty, & \text{if } x < 0, \\ \alpha\delta(x - a), & \text{if } x \geq 0, \end{cases}$$

where a and α are positive real constants with the appropriate units (see Figure 2.18). A particle starts out in the “well” ($0 < x < a$), but because of tunneling its wave function gradually “leaks” out through the delta-function barrier.

- (a) Solve the (time-independent) Schrödinger equation for this potential; impose appropriate boundary conditions, and determine the “energy”, E . (An implicit equation will do.)
- (b) I put the word “energy” in quotes because you’ll notice that it is a *complex number*! How do you account for this, in view of the theorem you proved in Problem 2.1a?
- (c) Writing $E = E_0 + i\Gamma$ (with E_0 and Γ real), calculate (in terms of Γ) the characteristic time it takes the particle to leak out of the well (that is, the time it takes before the probability is $1/e$ that it’s still in the region $0 < x < a$).

³²This rare example of an exact closed-form solution to the time-dependent Schrödinger equation was discovered by Schrödinger himself, in 1926.

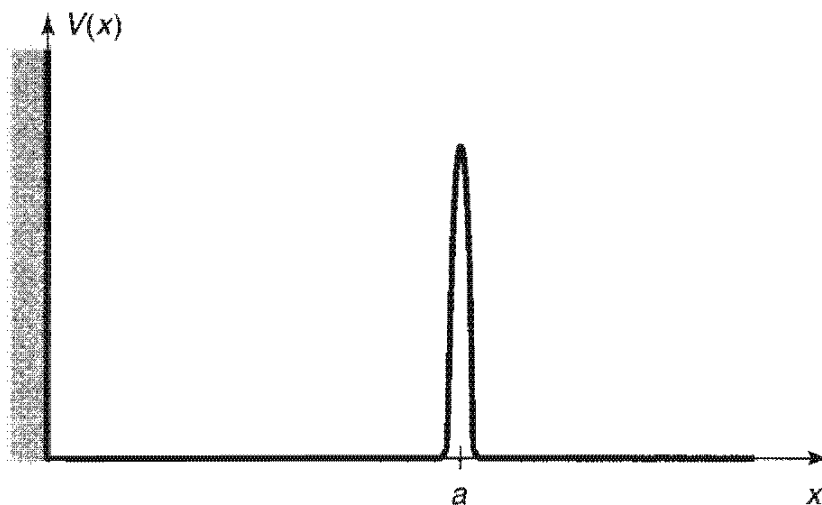

Figure 2.18: The potential for Problem 2.46.

****Problem 2.47** Consider the *moving* delta-function well:

$$V(x, t) = -\alpha\delta(x - vt),$$

where v is the (constant) velocity of the well.

(a) Show that the time-dependent Schrödinger equation admits the exact solution

$$\Psi(x, t) = \frac{\sqrt{m\alpha}}{\hbar} e^{-m\alpha|x-vt|/\hbar^2} e^{-i[(E+(1/2)mv^2)t-mvx]/\hbar},$$

where $E = -m\alpha^2/2\hbar^2$ is the bound-state energy of the *stationary* delta function.

Hint: Plug it in and *check* it! Use Problem 2.24b.

(b) Find the expectation value of the Hamiltonian in this state, and comment on the result.

*****Problem 2.48** Consider the potential

$$V(x) = -\frac{\hbar^2 a^2}{m} \operatorname{sech}^2(ax),$$

where a is a positive constant and “sech” stands for the hyperbolic secant.

(a) Show that this potential has the bound state

$$\psi_0(x) = A \operatorname{sech}(ax),$$

and find its energy. Normalize ψ_0 , and sketch its graph.

(b) Show that the function

$$\psi_k(x) = A \left(\frac{ik - a \tanh(ax)}{ik + a} \right) e^{ikx}$$

(where $k \equiv \sqrt{2mE}/\hbar$, as usual) solves the Schrödinger equation for any (positive) energy E . Since $\tanh z \rightarrow -1$ as $z \rightarrow -\infty$,

$$\psi_k(x) \approx Ae^{ikx}, \quad \text{for large negative } x.$$

This represents, then, a wave coming in from the left with *no accompanying reflected wave* [i.e., no term $\exp(-ikx)$]. What is the asymptotic form of $\psi_k(x)$ at large positive x ? What are R and T for this potential? *Note:* sech^2 is a famous example of a “reflectionless” potential—every incident particle, regardless of its energy, passes right through. See R. E. Crandall and B. R. Litt, *Annals of Physics* **146**, 458 (1983).

- (c) Construct the S -matrix for this potential, and use it to locate the bound states. How many of them are there? What are their energies? Check that your answer is consistent with part (a).

*****Problem 2.49** The S -matrix tells you the *outgoing* amplitudes (B and F) in terms of the *incoming* amplitudes (A and G):

$$\begin{pmatrix} B \\ F \end{pmatrix} = \begin{pmatrix} S_{11} & S_{12} \\ S_{21} & S_{22} \end{pmatrix} \begin{pmatrix} A \\ G \end{pmatrix}.$$

For some purposes it is more convenient to work with the **transfer matrix**, \mathbf{M} , which gives you the amplitudes to the *right* of the potential (F and G) in terms of those to the *left* (A and B):

$$\begin{pmatrix} F \\ G \end{pmatrix} = \begin{pmatrix} M_{11} & M_{12} \\ M_{21} & M_{22} \end{pmatrix} \begin{pmatrix} A \\ B \end{pmatrix}.$$

- (a) Find the four elements of the M -matrix in terms of the elements of the S -matrix, and vice versa. Express R_l , T_l , R_r , and T_r (Equations 2.161 and 2.162) in terms of elements of the M -matrix.
- (b) Suppose you have a potential consisting of two isolated pieces (Figure 2.19). Show that the M -matrix for the combination is the *product* of the two M -matrices for each section separately:

$$\mathbf{M} = \mathbf{M}_2\mathbf{M}_1.$$

(This obviously generalizes to any number of pieces, and accounts for the usefulness of the M -matrix.)

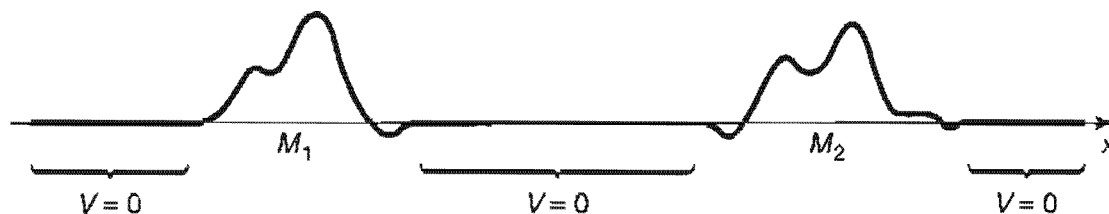

Figure 2.19: A potential consisting of two isolated pieces (Problem 2.49).

- (c) Construct the M -matrix for scattering from a single delta-function potential at point a :

$$V(x) = -\alpha\delta(x - a).$$

- (d) By the method of part (b), find the M -matrix for scattering from the double delta function

$$V(x) = -\alpha[\delta(x + a) + \delta(x - a)].$$

What is the transmission coefficient for this potential?

CHAPTER 3

FORMALISM

3.1 LINEAR ALGEBRA

The purpose of this chapter is to develop the *formalism* of quantum mechanics—terminology, notation, and mathematical background that illuminate the structure of the theory, facilitate practical calculations, and motivate a fundamental extension of the statistical interpretation. I begin with a brief survey of linear algebra.¹ Linear algebra abstracts and generalizes the arithmetic of ordinary vectors, as we encounter them in first-year physics. The generalization is in two directions: (1) We allow the scalars to be *complex*, and (2) we do not restrict ourselves to three dimensions (indeed, in Section 3.2 we shall be working with vectors that live in spaces of *infinite* dimension).

3.1.1 Vectors

A **vector space** consists of a set of **vectors** ($|\alpha\rangle, |\beta\rangle, |\gamma\rangle, \dots$), together with a set of **scalars** (a, b, c, \dots),² which are subject to two operations—vector addition and scalar multiplication:

¹If you have already studied linear algebra, you should be able to skim this section quickly, but I wouldn't skip it altogether, because some of the notation may be unfamiliar. If, on the other hand, this material is new to you, be warned that I am only summarizing (often without proof) those aspects of the theory we will be needing later. For details, you should refer to a text on linear algebra, such as the classic by P. R. Halmos: *Finite Dimensional Vector Spaces*, 2nd ed. (Princeton, NJ: van Nostrand, 1958).

²For our purposes, the scalars will be ordinary complex numbers. Mathematicians can tell you about vector spaces over more exotic fields, but such objects play no role in quantum mechanics.

Vector addition. The “sum” of any two vectors is another vector:

$$|\alpha\rangle + |\beta\rangle = |\gamma\rangle. \quad [3.1]$$

Vector addition is **commutative**

$$|\alpha\rangle + |\beta\rangle = |\beta\rangle + |\alpha\rangle, \quad [3.2]$$

and **associative**

$$|\alpha\rangle + (|\beta\rangle + |\gamma\rangle) = (|\alpha\rangle + |\beta\rangle) + |\gamma\rangle. \quad [3.3]$$

There exists a **zero** (or **null**) **vector**,³ $|0\rangle$, with the property that

$$|\alpha\rangle + |0\rangle = |\alpha\rangle, \quad [3.4]$$

for every vector $|\alpha\rangle$. And for every vector $|\alpha\rangle$ there is an associated **inverse vector** ($|-\alpha\rangle$), such that

$$|\alpha\rangle + |-\alpha\rangle = |0\rangle. \quad [3.5]$$

Scalar multiplication. The “product” of any scalar with any vector is another vector:

$$a|\alpha\rangle = |\gamma\rangle. \quad [3.6]$$

Scalar multiplication is **distributive** with respect to vector addition

$$a(|\alpha\rangle + |\beta\rangle) = a|\alpha\rangle + a|\beta\rangle \quad [3.7]$$

and with respect to scalar addition

$$(a + b)|\alpha\rangle = a|\alpha\rangle + b|\alpha\rangle. \quad [3.8]$$

It is also **associative** with respect to the ordinary multiplication of scalars:

$$a(b|\alpha\rangle) = (ab)|\alpha\rangle. \quad [3.9]$$

Multiplication by the scalars 0 and 1 has the effect you would expect:

$$0|\alpha\rangle = |0\rangle; \quad 1|\alpha\rangle = |\alpha\rangle. \quad [3.10]$$

Evidently $|-\alpha\rangle = (-1)|\alpha\rangle$.

There’s a lot less here than meets the eye—all I have done is to write down in abstract language the familiar rules for manipulating vectors. The virtue of such abstraction is that we will be able to apply our knowledge and intuition about the behavior of ordinary vectors to other systems that happen to share the same formal properties.

³It is customary, where no confusion can arise, to write the null vector without the adorning bracket: $|0\rangle \rightarrow 0$.

A **linear combination** of the vectors $|\alpha\rangle, |\beta\rangle, |\gamma\rangle, \dots$ is an expression of the form

$$a|\alpha\rangle + b|\beta\rangle + c|\gamma\rangle + \dots \quad [3.11]$$

A vector $|\lambda\rangle$ is said to be **linearly independent** of the set $|\alpha\rangle, |\beta\rangle, |\gamma\rangle, \dots$ if it cannot be written as a linear combination of them. (For example, in three dimensions the unit vector \hat{k} is linearly independent of \hat{i} and \hat{j} , but any vector in the xy -plane is linearly *dependent* on \hat{i} and \hat{j} .) By extension, a *set* of vectors is linearly independent if each one is linearly independent of all the rest. A collection of vectors is said to **span** the space if *every* vector can be written as a linear combination of the members of this set.⁴ A set of *linearly independent* vectors that spans the space is called a **basis**. The number of vectors in any basis is called the **dimension** of the space. For the moment we shall assume that the dimension (n) is *finite*.

With respect to a prescribed basis

$$|e_1\rangle, |e_2\rangle, \dots, |e_n\rangle, \quad [3.12]$$

any given vector

$$|\alpha\rangle = a_1|e_1\rangle + a_2|e_2\rangle + \dots + a_n|e_n\rangle \quad [3.13]$$

is uniquely represented by the (ordered) n -tuple of its **components**:

$$|\alpha\rangle \leftrightarrow (a_1, a_2, \dots, a_n). \quad [3.14]$$

It is often easier to work with the components than with the abstract vectors themselves. To add vectors, you add their corresponding components:

$$|\alpha\rangle + |\beta\rangle \leftrightarrow (a_1 + b_1, a_2 + b_2, \dots, a_n + b_n); \quad [3.15]$$

to multiply by a scalar you multiply each component:

$$c|\alpha\rangle \leftrightarrow (ca_1, ca_2, \dots, ca_n); \quad [3.16]$$

the null vector is represented by a string of zeroes:

$$|0\rangle \leftrightarrow (0, 0, \dots, 0); \quad [3.17]$$

and the components of the inverse vector have their signs reversed:

$$|-\alpha\rangle \leftrightarrow (-a_1, -a_2, \dots, -a_n). \quad [3.18]$$

The only *disadvantage* of working with components is that you have to commit yourself to a particular basis, and the same manipulations will look very different to someone working in a different basis.

Problem 3.1 Consider the ordinary vectors in three dimensions $(a_x\hat{i} + a_y\hat{j} + a_z\hat{k})$ with complex components.

⁴A set of vectors that spans the space is also called **complete**, though I personally reserve that word for the infinite-dimensional case, where subtle questions of convergence arise.

- (a) Does the subset of all vectors with $a_z = 0$ constitute a vector space? If so, what is its dimension; if not, why not?
- (b) What about the subset of all vectors whose z component is 1?
- (c) How about the subset of vectors whose components are all equal?

***Problem 3.2** Consider the collection of all polynomials (with complex coefficients) of degree $< N$ in x .

- (a) Does this set constitute a vector space (with the polynomials as “vectors”)? If so, suggest a convenient basis, and give the dimension of the space. If not, which of the defining properties does it lack?
- (b) What if we require that the polynomials be *even* functions?
- (c) What if we require that the leading coefficient (i.e., the number multiplying x^{N-1}) be 1?
- (d) What if we require that the polynomials have the value 0 at $x = 1$?
- (e) What if we require that the polynomials have the value 1 at $x = 0$?

Problem 3.3 Prove that the components of a vector with respect to a given basis are *unique*.

3.1.2 Inner Products

In three dimensions we encounter two kinds of vector products: the dot product and the cross product. The latter does not generalize in any natural way to n -dimensional vector spaces, but the former *does*—in this context it is usually called the **inner product**. The inner product of two vectors ($|\alpha\rangle$ and $|\beta\rangle$) is a complex number (which we write as $\langle\alpha|\beta\rangle$), with the following properties:

$$\langle\beta|\alpha\rangle = \langle\alpha|\beta\rangle^*, \quad [3.19]$$

$$\langle\alpha|\alpha\rangle \geq 0, \quad \text{and } \langle\alpha|\alpha\rangle = 0 \Leftrightarrow |\alpha\rangle = |0\rangle, \quad [3.20]$$

$$\langle\alpha|(b|\beta\rangle + c|\gamma\rangle) = b\langle\alpha|\beta\rangle + c\langle\alpha|\gamma\rangle. \quad [3.21]$$

Apart from the generalization to complex numbers, these axioms simply codify the familiar behavior of dot products. A vector space with an inner product is called an **inner product space**.

Because the inner product of any vector with itself is a nonnegative number (Equation 3.20), its square root is *real*—we call this the **norm** of the vector:

$$\|\alpha\| \equiv \sqrt{\langle\alpha|\alpha\rangle}; \quad [3.22]$$

it generalizes the notion of “length”. A “unit” vector, whose norm is 1, is said to be **normalized** (the word should really be “normal”, but I guess that sounds too anthropomorphic). Two vectors whose inner product is zero are called **orthogonal** (generalizing the notion of “perpendicular”). A collection of mutually orthogonal normalized vectors,

$$\langle \alpha_i | \alpha_j \rangle = \delta_{ij}, \quad [3.23]$$

is called an **orthonormal set**. It is always possible (see Problem 3.4), and almost always convenient, to choose an *orthonormal basis*; in that case the inner product of two vectors can be written very neatly in terms of their components:

$$\langle \alpha | \beta \rangle = a_1^* b_1 + a_2^* b_2 + \cdots + a_n^* b_n, \quad [3.24]$$

the norm (squared) becomes

$$\langle \alpha | \alpha \rangle = |a_1|^2 + |a_2|^2 + \cdots + |a_n|^2, \quad [3.25]$$

and the components themselves are

$$a_i = \langle e_i | \alpha \rangle. \quad [3.26]$$

(These results generalize the familiar formulas $\mathbf{a} \cdot \mathbf{b} = a_x b_x + a_y b_y + a_z b_z$, $\mathbf{a} \cdot \mathbf{a} = a_x^2 + a_y^2 + a_z^2$, and $a_x = \hat{i} \cdot \mathbf{a}$, $a_y = \hat{j} \cdot \mathbf{a}$, $a_z = \hat{k} \cdot \mathbf{a}$, for the three-dimensional orthonormal basis $\hat{i}, \hat{j}, \hat{k}$.) From now on we shall *always* work in orthonormal bases unless it is explicitly indicated otherwise.

Another geometrical quantity one might wish to generalize is the *angle* between two vectors. In ordinary vector analysis $\cos \theta = (\mathbf{a} \cdot \mathbf{b}) / |\mathbf{a}| |\mathbf{b}|$. But because the inner product is in general a complex number, the analogous formula (in an arbitrary inner product space) does not define a (real) angle θ . Nevertheless, it is still true that the *absolute value* of this quantity is a number no greater than 1,

$$|\langle \alpha | \beta \rangle|^2 \leq \langle \alpha | \alpha \rangle \langle \beta | \beta \rangle. \quad [3.27]$$

(This important result is known as the **Schwarz inequality**; the proof is given in Problem 3.5.) So you can, if you like, define the angle between $|\alpha\rangle$ and $|\beta\rangle$ by the formula

$$\cos \theta = \sqrt{\frac{\langle \alpha | \beta \rangle \langle \beta | \alpha \rangle}{\langle \alpha | \alpha \rangle \langle \beta | \beta \rangle}}. \quad [3.28]$$

***Problem 3.4** Suppose you start out with a basis $(|e_1\rangle, |e_2\rangle, \dots, |e_n\rangle)$ that is *not* orthonormal. The **Gram-Schmidt procedure** is a systematic ritual for generating from it an orthonormal basis $(|e'_1\rangle, |e'_2\rangle, \dots, |e'_n\rangle)$. It goes like this:

(i) Normalize the first basis vector (divide by its norm):

$$|e'_1\rangle = \frac{|e_1\rangle}{\|e_1\|}.$$

(ii) Find the projection of the second vector along the first, and subtract it off:

$$|e_2\rangle - \langle e'_1|e_2\rangle|e'_1\rangle.$$

This vector is orthogonal to $|e'_1\rangle$; normalize it to get $|e'_2\rangle$.

(iii) Subtract from $|e_3\rangle$ its projections along $|e'_1\rangle$ and $|e'_2\rangle$:

$$|e_3\rangle - \langle e'_1|e_3\rangle|e'_1\rangle - \langle e'_2|e_3\rangle|e'_2\rangle.$$

This is orthogonal to $|e'_1\rangle$ and $|e'_2\rangle$; normalize it to get $|e'_3\rangle$. And so on.

Use the Gram-Schmidt procedure to orthonormalize the three-space basis $|e_1\rangle = (1+i)\hat{i} + (1)\hat{j} + (i)\hat{k}$, $|e_2\rangle = (i)\hat{i} + (3)\hat{j} + (1)\hat{k}$, $|e_3\rangle = (0)\hat{i} + (28)\hat{j} + (0)\hat{k}$.

Problem 3.5 Prove the Schwarz inequality (Equation 3.27). *Hint:* Let $|\gamma\rangle = |\beta\rangle - (\langle\alpha|\beta\rangle/\langle\alpha|\alpha\rangle)|\alpha\rangle$, and use $\langle\gamma|\gamma\rangle \geq 0$.

Problem 3.6 Find the angle (in the sense of Equation 3.28) between the vectors $|\alpha\rangle = (1+i)\hat{i} + (1)\hat{j} + (i)\hat{k}$ and $|\beta\rangle = (4-i)\hat{i} + (0)\hat{j} + (2-2i)\hat{k}$.

Problem 3.7 Prove the **triangle inequality**: $\|(|\alpha\rangle + |\beta\rangle)\| \leq \|\alpha\| + \|\beta\|$.

3.1.3 Linear Transformations

Suppose you take every vector (in three-space) and multiply it by 17, or you rotate every vector by 39° about the z -axis, or you reflect every vector in the xy -plane—these are all examples of **linear transformations**. A linear transformation⁵ (\hat{T}) takes each vector in a vector space and “transforms” it into some other vector ($|\alpha\rangle \rightarrow |\alpha'\rangle = \hat{T}|\alpha\rangle$), with the proviso that the operation is *linear*:

$$\hat{T}(a|\alpha\rangle + b|\beta\rangle) = a(\hat{T}|\alpha\rangle) + b(\hat{T}|\beta\rangle), \quad [3.29]$$

for any vectors $|\alpha\rangle$, $|\beta\rangle$ and any scalars a , b .

If you know what a particular linear transformation does to a set of *basis* vectors, you can easily figure out what it does to *any* vector. For suppose that

$$\begin{aligned} \hat{T}|e_1\rangle &= T_{11}|e_1\rangle + T_{21}|e_2\rangle + \cdots + T_{n1}|e_n\rangle, \\ \hat{T}|e_2\rangle &= T_{12}|e_1\rangle + T_{22}|e_2\rangle + \cdots + T_{n2}|e_n\rangle, \\ &\dots \\ \hat{T}|e_n\rangle &= T_{1n}|e_1\rangle + T_{2n}|e_2\rangle + \cdots + T_{nn}|e_n\rangle, \end{aligned}$$

or, more compactly,

$$\hat{T}|e_j\rangle = \sum_{i=1}^n T_{ij}|e_i\rangle, \quad (j = 1, 2, \dots, n). \quad [3.30]$$

⁵In this chapter I'll use a hat ($\hat{}$) to denote linear transformations; this is not inconsistent with my earlier convention (putting hats on operators), for (as we shall see) our operators *are* linear transformations.

If $|\alpha\rangle$ is an arbitrary vector:

$$|\alpha\rangle = a_1|e_1\rangle + a_2|e_2\rangle + \cdots + a_n|e_n\rangle = \sum_{j=1}^n a_j|e_j\rangle, \quad [3.31]$$

then

$$\hat{T}|\alpha\rangle = \sum_{j=1}^n a_j(\hat{T}|e_j\rangle) = \sum_{j=1}^n \sum_{i=1}^n a_j T_{ij}|e_i\rangle = \sum_{i=1}^n \left(\sum_{j=1}^n T_{ij} a_j\right)|e_i\rangle. \quad [3.32]$$

Evidently \hat{T} takes a vector with components a_1, a_2, \dots, a_n into a vector with components⁶

$$a'_i = \sum_{j=1}^n T_{ij} a_j. \quad [3.33]$$

Thus the n^2 **elements** T_{ij} uniquely characterize the linear transformation \hat{T} (with respect to a given basis), just as the n components a_i uniquely characterize the vector $|\alpha\rangle$ (with respect to the same basis):

$$\hat{T} \leftrightarrow (T_{11}, T_{12}, \dots, T_{nn}). \quad [3.34]$$

If the basis is orthonormal, it follows from Equation 3.30 that

$$T_{ij} = \langle e_i | \hat{T} | e_j \rangle. \quad [3.35]$$

It is convenient to display these complex numbers in the form of a **matrix**⁷:

$$\mathbf{T} = \begin{pmatrix} T_{11} & T_{12} & \cdots & T_{1n} \\ T_{21} & T_{22} & \cdots & T_{2n} \\ \vdots & \vdots & & \vdots \\ T_{n1} & T_{n2} & \cdots & T_{nn} \end{pmatrix}. \quad [3.36]$$

The study of linear transformations, then, reduces to the theory of matrices. The *sum* of two linear transformations ($\hat{S} + \hat{T}$) is defined in the natural way:

$$(\hat{S} + \hat{T})|\alpha\rangle = \hat{S}|\alpha\rangle + \hat{T}|\alpha\rangle; \quad [3.37]$$

this matches the usual rule for adding matrices (you add their corresponding elements):

$$\mathbf{U} = \mathbf{S} + \mathbf{T} \Leftrightarrow U_{ij} = S_{ij} + T_{ij}. \quad [3.38]$$

⁶Notice the reversal of indices between Equations 3.30 and 3.33. This is not a typographical error. Another way of putting it (switching $i \leftrightarrow j$ in Equation 3.30) is that if the *components* transform with T_{ij} , the *basis* vectors transform with T_{ji} .

⁷I'll use boldface to denote matrices.

The *product* of two linear transformations ($\hat{S}\hat{T}$) is the net effect of performing them in succession—first \hat{T} , then \hat{S} :

$$|\alpha\rangle \rightarrow |\alpha'\rangle = \hat{T}|\alpha\rangle \rightarrow |\alpha''\rangle = \hat{S}|\alpha'\rangle = \hat{S}(\hat{T}|\alpha\rangle) = \hat{S}\hat{T}|\alpha\rangle. \quad [3.39]$$

What matrix \mathbf{U} represents the combined transformation $\hat{U} = \hat{S}\hat{T}$? It's not hard to work it out:

$$a''_i = \sum_{j=1}^n S_{ij}a'_j = \sum_{j=1}^n S_{ij} \left(\sum_{k=1}^n T_{jk}a_k \right) = \sum_{k=1}^n \left(\sum_{j=1}^n S_{ij}T_{jk} \right) a_k = \sum_{k=1}^n U_{ik}a_k.$$

Evidently

$$\mathbf{U} = \mathbf{S}\mathbf{T} \Leftrightarrow U_{ik} = \sum_{j=1}^n S_{ij}T_{jk}; \quad [3.40]$$

this is the standard rule for matrix multiplication—to find the ik^{th} element of the product, you look at the i^{th} row of \mathbf{S} and the k^{th} column of \mathbf{T} , multiply corresponding entries, and add. The same procedure allows you to multiply *rectangular* matrices, as long as the number of columns in the first matches the number of rows in the second. In particular, if we write the n -tuple of components of $|\alpha\rangle$ as an $n \times 1$ **column matrix**

$$\mathbf{a} \equiv \begin{pmatrix} a_1 \\ a_2 \\ \vdots \\ a_n \end{pmatrix}, \quad [3.41]$$

the transformation rule (Equation 3.33) can be written

$$\mathbf{a}' = \mathbf{T}\mathbf{a}. \quad [3.42]$$

And now, some useful matrix terminology: The **transpose** of a matrix (which we shall write with a tilde: $\tilde{\mathbf{T}}$) is the same set of elements, but with rows and columns interchanged:

$$\tilde{\mathbf{T}} = \begin{pmatrix} T_{11} & T_{21} & \dots & T_{n1} \\ T_{12} & T_{22} & \dots & T_{n2} \\ \vdots & \vdots & & \vdots \\ T_{1n} & T_{2n} & \dots & T_{nn} \end{pmatrix}. \quad [3.43]$$

Notice that the transpose of a *column* matrix is a **row matrix**:

$$\tilde{\mathbf{a}} = (a_1 \quad a_2 \quad \dots \quad a_n). \quad [3.44]$$

A square matrix is **symmetric** if it is equal to its transpose (reflection in the **main diagonal**—upper left to lower right—leaves it unchanged); it is **antisymmetric** if this operation reverses the sign:

$$\text{SYMMETRIC: } \tilde{\mathbf{T}} = \mathbf{T}; \quad \text{ANTISYMMETRIC: } \tilde{\mathbf{T}} = -\mathbf{T}. \quad [3.45]$$

To construct the (complex) **conjugate** of a matrix (which we denote, as usual, with an asterisk: \mathbf{T}^*), you take the complex conjugate of every element:

$$\mathbf{T}^* = \begin{pmatrix} T_{11}^* & T_{12}^* & \cdots & T_{1n}^* \\ T_{21}^* & T_{22}^* & \cdots & T_{2n}^* \\ \vdots & \vdots & & \vdots \\ T_{n1}^* & T_{n2}^* & \cdots & T_{nn}^* \end{pmatrix}; \quad \mathbf{a}^* = \begin{pmatrix} a_1^* \\ a_2^* \\ \vdots \\ a_n^* \end{pmatrix}. \quad [3.46]$$

A matrix is **real** if all its elements are real and **imaginary** if they are all imaginary:

$$\text{REAL: } \mathbf{T}^* = \mathbf{T}; \quad \text{IMAGINARY: } \mathbf{T}^* = -\mathbf{T}. \quad [3.47]$$

The **Hermitian conjugate** (or **adjoint**) of a matrix (indicated by a dagger: \mathbf{T}^\dagger) is the transposed conjugate:

$$\mathbf{T}^\dagger \equiv \tilde{\mathbf{T}}^* = \begin{pmatrix} T_{11}^* & T_{21}^* & \cdots & T_{n1}^* \\ T_{12}^* & T_{22}^* & \cdots & T_{n2}^* \\ \vdots & \vdots & & \vdots \\ T_{1n}^* & T_{2n}^* & \cdots & T_{nn}^* \end{pmatrix}; \quad \mathbf{a}^\dagger \equiv \tilde{\mathbf{a}}^* = (a_1^* \ a_2^* \ \cdots \ a_n^*). \quad [3.48]$$

A square matrix is **Hermitian** (or **self-adjoint**) if it is equal to its Hermitian conjugate; if Hermitian conjugation introduces a minus sign, the matrix is **skew Hermitian** (or **anti-Hermitian**):

$$\text{HERMITIAN: } \mathbf{T}^\dagger = \mathbf{T}; \quad \text{SKEW HERMITIAN: } \mathbf{T}^\dagger = -\mathbf{T}. \quad [3.49]$$

With this notation the inner product of two vectors (with respect to an orthonormal basis—Equation 3.24), can be written very neatly in matrix form:

$$\langle \alpha | \beta \rangle = \mathbf{a}^\dagger \mathbf{b}. \quad [3.50]$$

(Notice that each of the three operations discussed in this paragraph, if applied twice, returns you to the original matrix.)

Matrix multiplication is not, in general, commutative ($\mathbf{ST} \neq \mathbf{TS}$); the difference between the two orderings is called the **commutator**:

$$[\mathbf{S}, \mathbf{T}] \equiv \mathbf{ST} - \mathbf{TS}. \quad [3.51]$$

The transpose of a product is the product of the transposes *in reverse order*:

$$(\tilde{\mathbf{ST}}) = \tilde{\mathbf{T}}\tilde{\mathbf{S}} \quad [3.52]$$

(see Problem 3.12), and the same goes for Hermitian conjugates:

$$(\mathbf{ST})^\dagger = \mathbf{T}^\dagger \mathbf{S}^\dagger. \quad [3.53]$$

The **unit matrix** (representing a linear transformation that carries every vector into itself) consists of ones on the main diagonal and zeroes everywhere else:

$$\mathbf{1} \equiv \begin{pmatrix} 1 & 0 & \dots & 0 \\ 0 & 1 & \dots & 0 \\ \vdots & \vdots & & \vdots \\ 0 & 0 & \dots & 1 \end{pmatrix}. \quad [3.54]$$

In other words,

$$\mathbf{1}_{ij} = \delta_{ij}. \quad [3.55]$$

The **inverse** of a matrix (written \mathbf{T}^{-1}) is defined in the obvious way:

$$\mathbf{T}^{-1}\mathbf{T} = \mathbf{T}\mathbf{T}^{-1} = \mathbf{1}. \quad [3.56]$$

A matrix has an inverse if and only if its **determinant**⁸ is nonzero; in fact,

$$\mathbf{T}^{-1} = \frac{1}{\det \mathbf{T}} \tilde{\mathbf{C}}, \quad [3.57]$$

where \mathbf{C} is the matrix of **cofactors** [the cofactor of element T_{ij} is $(-1)^{i+j}$ times the determinant of the submatrix obtained from \mathbf{T} by erasing the i^{th} row and the j^{th} column]. A matrix without an inverse is said to be **singular**. The inverse of a product (assuming it exists) is the product of the inverses *in reverse order*:

$$(\mathbf{ST})^{-1} = \mathbf{T}^{-1}\mathbf{S}^{-1}. \quad [3.58]$$

A matrix is **unitary** if its inverse is equal to its Hermitian conjugate:

$$\text{UNITARY: } \mathbf{U}^\dagger = \mathbf{U}^{-1}. \quad [3.59]$$

Assuming the basis is orthonormal, the columns of a unitary matrix constitute an orthonormal set, and so too do its rows (see Problem 3.16).

The components of a given vector depend on your (arbitrary) choice of basis, as do the elements in the matrix representing a given linear transformation. We might inquire how these numbers change when we switch to a different basis. The old basis vectors $|e_i\rangle$ are—like *all* vectors—linear combinations of the new ones:

$$\begin{aligned} |e_1\rangle &= S_{11}|f_1\rangle + S_{21}|f_2\rangle + \dots + S_{n1}|f_n\rangle, \\ |e_2\rangle &= S_{12}|f_1\rangle + S_{22}|f_2\rangle + \dots + S_{n2}|f_n\rangle, \\ &\dots \\ |e_n\rangle &= S_{1n}|f_1\rangle + S_{2n}|f_2\rangle + \dots + S_{nn}|f_n\rangle \end{aligned}$$

⁸I assume you know how to evaluate determinants. If not, see M. Boas, *Mathematical Methods in the Physical Sciences*, 2nd ed. (New York: John Wiley, 1983), Section 3.3.

(for some set of complex numbers S_{ij}), or, more compactly,

$$|e_j\rangle = \sum_{i=1}^n S_{ij}|f_i\rangle, \quad (j = 1, 2, \dots, n). \quad [3.60]$$

This is *itself* a linear transformation (compare Equation 3.30),⁹ and we know immediately how the components transform:

$$a_i^f = \sum_{j=1}^n S_{ij}a_j^e \quad [3.61]$$

(where the superscript indicates the basis). In matrix form

$$\mathbf{a}^f = \mathbf{S}\mathbf{a}^e. \quad [3.62]$$

What about the matrix representing a given linear transformation \hat{T} —how is it modified by a change of basis? In the old basis we had (Equation 3.42)

$$\mathbf{a}^{e'} = \mathbf{T}^e \mathbf{a}^e,$$

and Equation 3.62—multiplying both sides by \mathbf{S}^{-1} —entails¹⁰ $\mathbf{a}^e = \mathbf{S}^{-1}\mathbf{a}^f$, so

$$\mathbf{a}^{f'} = \mathbf{S}\mathbf{a}^{e'} = \mathbf{S}(\mathbf{T}^e \mathbf{a}^e) = \mathbf{S}\mathbf{T}^e \mathbf{S}^{-1}\mathbf{a}^f.$$

Evidently

$$\mathbf{T}^f = \mathbf{S}\mathbf{T}^e \mathbf{S}^{-1}. \quad [3.63]$$

In general, two matrices (\mathbf{T}_1 and \mathbf{T}_2) are said to be **similar** if $\mathbf{T}_2 = \mathbf{S}\mathbf{T}_1\mathbf{S}^{-1}$ for some (nonsingular) matrix \mathbf{S} . What we have just found is that similar matrices represent the same linear transformation with respect to two different bases. Incidentally, if the first basis is orthonormal, the second will also be orthonormal if and only if the matrix \mathbf{S} is *unitary* (see Problem 3.14). Since we always work in orthonormal bases, we are interested mainly in unitary similarity transformations.

While the *elements* of the matrix representing a given linear transformation may look very different in the new basis, two numbers associated with the matrix are unchanged: the **determinant** and the **trace**. For the determinant of a product is the product of the determinants, and hence

$$\det(\mathbf{T}^f) = \det(\mathbf{S}\mathbf{T}^e\mathbf{S}^{-1}) = \det(\mathbf{S})\det(\mathbf{T}^e)\det(\mathbf{S}^{-1}) = \det \mathbf{T}^e. \quad [3.64]$$

⁹Notice, however, the radically different perspective: In this case we're talking about one and the same *vector*, referred to two different *bases*, whereas before we were thinking of a completely *different* vector, referred to the *same* basis.

¹⁰Note that \mathbf{S}^{-1} certainly exists—if \mathbf{S} were singular, the $|f_i\rangle$'s would not span the space, so they wouldn't constitute a basis.

And the trace, which is the sum of the diagonal elements,

$$\text{Tr}(\mathbf{T}) \equiv \sum_{i=1}^m T_{ii}, \quad [3.65]$$

has the property (see Problem 3.15) that

$$\text{Tr}(\mathbf{T}_1\mathbf{T}_2) = \text{Tr}(\mathbf{T}_2\mathbf{T}_1), \quad [3.66]$$

(for any two matrices \mathbf{T}_1 and \mathbf{T}_2), so that

$$\text{Tr}(\mathbf{T}^f) = \text{Tr}(\mathbf{S}\mathbf{T}^e\mathbf{S}^{-1}) = \text{Tr}(\mathbf{T}^e\mathbf{S}^{-1}\mathbf{S}) = \text{Tr}(\mathbf{T}^e). \quad [3.67]$$

Problem 3.8 Using the standard basis (\hat{i} , \hat{j} , \hat{k}) for vectors in three dimensions:

- (a) Construct the matrix representing a rotation through angle θ (counterclockwise, looking down the axis toward the origin) about the z -axis.
- (b) Construct the matrix representing a rotation by 120° (counterclockwise, looking down the axis) about an axis through the point $(1,1,1)$.
- (c) Construct the matrix representing reflection in the xy -plane.
- (d) Are **translations** ($x \rightarrow x + x_0$, $y \rightarrow y + y_0$, $z \rightarrow z + z_0$, for some constants x_0 , y_0 , z_0) linear transformations? If so, find the matrix which represents them; if not, explain why not.

***Problem 3.9** Given the following two matrices:

$$\mathbf{A} = \begin{pmatrix} -1 & 1 & i \\ 2 & 0 & 3 \\ 2i & -2i & 2 \end{pmatrix}, \quad \mathbf{B} = \begin{pmatrix} 2 & 0 & -i \\ 0 & 1 & 0 \\ i & 3 & 2 \end{pmatrix},$$

compute (a) $\mathbf{A} + \mathbf{B}$, (b) \mathbf{AB} , (c) $[\mathbf{A}, \mathbf{B}]$, (d) $\tilde{\mathbf{A}}$, (e) \mathbf{A}^* , (f) \mathbf{A}^\dagger , (g) $\text{Tr}(\mathbf{B})$, (h) $\det(\mathbf{B})$, and (i) \mathbf{B}^{-1} . Check that $\mathbf{BB}^{-1} = \mathbf{1}$. Does \mathbf{A} have an inverse?

***Problem 3.10** Using the square matrices in Problem 3.9 and the column matrices

$$\mathbf{a} = \begin{pmatrix} i \\ 2i \\ 2 \end{pmatrix}, \quad \mathbf{b} = \begin{pmatrix} 2 \\ (1-i) \\ 0 \end{pmatrix},$$

find (a) \mathbf{Aa} , (b) $\mathbf{a}^\dagger\mathbf{b}$, (c) $\tilde{\mathbf{a}}\mathbf{Bb}$, (d) \mathbf{ab}^\dagger .

Problem 3.11 By explicit construction of the matrices in question, show that any matrix \mathbf{T} can be written

- (a) as the sum of a symmetric matrix \mathbf{S} and an antisymmetric matrix \mathbf{A} ;

- (b) as the sum of a real matrix \mathbf{R} and an imaginary matrix \mathbf{I} ;
- (c) as the sum of a Hermitian matrix \mathbf{H} and a skew-Hermitian matrix \mathbf{K} .

***Problem 3.12** Prove Equations 3.52, 3.53, and 3.58. Show that the product of two unitary matrices is unitary. Under what conditions is the product of two Hermitian matrices Hermitian? Is the sum of two unitary matrices unitary? Is the sum of two Hermitian matrices Hermitian?

Problem 3.13 In the usual basis $(\hat{i}, \hat{j}, \hat{k})$, construct the matrix \mathbf{T}_x representing a rotation through angle θ about the x -axis, and the matrix \mathbf{T}_y representing a rotation through angle θ about the y -axis. Suppose now we change bases, to $\hat{i}' = \hat{j}$, $\hat{j}' = -\hat{i}$, $\hat{k}' = \hat{k}$. Construct the matrix \mathbf{S} that effects this change of basis, and check that $\mathbf{S}\mathbf{T}_x\mathbf{S}^{-1}$ and $\mathbf{S}\mathbf{T}_y\mathbf{S}^{-1}$ are what you would expect.

Problem 3.14 Show that similarity preserves matrix multiplication (that is if $\mathbf{A}^e\mathbf{B}^e = \mathbf{C}^e$, then $\mathbf{A}^f\mathbf{B}^f = \mathbf{C}^f$). Similarity does *not*, in general, preserve symmetry, reality, or Hermiticity; show, however, that if \mathbf{S} is *unitary*, and \mathbf{H}^e is Hermitian, then \mathbf{H}^f is Hermitian. Show that \mathbf{S} carries an orthonormal basis into another orthonormal basis if and only if it is unitary.

***Problem 3.15** Prove that $\text{Tr}(\mathbf{T}_1\mathbf{T}_2) = \text{Tr}(\mathbf{T}_2\mathbf{T}_1)$. It follows immediately that $\text{Tr}(\mathbf{T}_1\mathbf{T}_2\mathbf{T}_3) = \text{Tr}(\mathbf{T}_2\mathbf{T}_3\mathbf{T}_1)$, but is it the case that $\text{Tr}(\mathbf{T}_1\mathbf{T}_2\mathbf{T}_3) = \text{Tr}(\mathbf{T}_2\mathbf{T}_1\mathbf{T}_3)$, in general? Prove it, or disprove it. *Hint*: The best disproof is always a counterexample—and the simpler the better!

Problem 3.16 Show that the rows and columns of a unitary matrix constitute orthonormal sets.

3.1.4 Eigenvectors and Eigenvalues

Consider the linear transformation in three-space consisting of a rotation, about some specified axis, by an angle θ . Most vectors will change in a rather complicated way (they ride around on a cone about the axis), but vectors that happen to lie *along* the axis have very simple behavior: They don't change at all ($\hat{T}|\alpha\rangle = |\alpha\rangle$). If θ is 180° , then vectors which lie in the the "equatorial" plane reverse signs ($\hat{T}|\alpha\rangle = -|\alpha\rangle$). In a complex vector space,¹¹ every linear transformation has "special" vectors like these, which are transformed into simple multiples of themselves:

$$\hat{T}|\alpha\rangle = \lambda|\alpha\rangle; \tag{3.68}$$

¹¹This is *not* always true in a *real* vector space (where the scalars are restricted to real values). See Problem 3.17.

they are called **eigenvectors** of the transformation, and the (complex) number λ is their **eigenvalue**. (The *null* vector doesn't count, even though, in a trivial sense, it obeys Equation 3.68 for *any* \hat{T} and *any* λ ; technically, an eigenvector is any *nonzero* vector satisfying Equation 3.68.) Notice that any (nonzero) multiple of an eigenvector is still an eigenvector with the same eigenvalue.

With respect to a particular basis, the eigenvector equation assumes the matrix form

$$\mathbf{T}\mathbf{a} = \lambda\mathbf{a} \quad [3.69]$$

(for nonzero \mathbf{a}), or

$$(\mathbf{T} - \lambda\mathbf{1})\mathbf{a} = \mathbf{0}. \quad [3.70]$$

(Here $\mathbf{0}$ is the **zero matrix**, whose elements are all zero.) Now, if the matrix $(\mathbf{T} - \lambda\mathbf{1})$ had an *inverse*, we could multiply both sides of Equation 3.70 by $(\mathbf{T} - \lambda\mathbf{1})^{-1}$, and conclude that $\mathbf{a} = \mathbf{0}$. But by assumption \mathbf{a} is *not* zero, so the matrix $(\mathbf{T} - \lambda\mathbf{1})$ must in fact be singular, which means that its determinant vanishes:

$$\det(\mathbf{T} - \lambda\mathbf{1}) = \begin{vmatrix} (T_{11} - \lambda) & T_{12} & \dots & T_{1n} \\ T_{21} & (T_{22} - \lambda) & \dots & T_{2n} \\ \vdots & \vdots & \ddots & \vdots \\ T_{n1} & T_{n2} & \dots & (T_{nn} - \lambda) \end{vmatrix} = 0. \quad [3.71]$$

Expansion of the determinant yields an algebraic equation for λ :

$$C_n\lambda^n + C_{n-1}\lambda^{n-1} + \dots + C_1\lambda + C_0 = 0, \quad [3.72]$$

where the coefficients C_i depend on the elements of \mathbf{T} (see Problem 3.19). This is called the **characteristic equation** for the matrix; its solutions determine the eigenvalues. Notice that it's an n th-order equation, so it has n (complex) roots.¹² However, some of these may be duplicates, so all we can say for certain is that an $n \times n$ matrix has *at least one* and *at most n* distinct eigenvalues. To construct the corresponding eigenvectors it is generally easiest simply to plug each λ back into Equation 3.69 and solve "by hand" for the components of \mathbf{a} . I'll show you how it goes by working out an example.

Example. Find the eigenvalues and eigenvectors of the following matrix:

$$\mathbf{M} = \begin{pmatrix} 2 & 0 & -2 \\ -2i & i & 2i \\ 1 & 0 & -1 \end{pmatrix}. \quad [3.73]$$

The characteristic equation is

$$\begin{vmatrix} (2 - \lambda) & 0 & -2 \\ -2i & (i - \lambda) & 2i \\ 1 & 0 & (-1 - \lambda) \end{vmatrix} = -\lambda^3 + (1 + i)\lambda^2 - i\lambda = 0, \quad [3.74]$$

¹²It is here that the case of *real* vector spaces becomes more awkward, because the characteristic equation need not have any (real) solutions at all. See footnote 11 and Problem 3.17.

and its roots are 0, 1, and i . Call the components of the first eigenvector (a_1, a_2, a_3) ; then

$$\begin{pmatrix} 2 & 0 & -2 \\ -2i & i & 2i \\ 1 & 0 & -1 \end{pmatrix} \begin{pmatrix} a_1 \\ a_2 \\ a_3 \end{pmatrix} = 0 \begin{pmatrix} a_1 \\ a_2 \\ a_3 \end{pmatrix} = \begin{pmatrix} 0 \\ 0 \\ 0 \end{pmatrix},$$

which yields three equations:

$$\begin{aligned} 2a_1 - 2a_3 &= 0, \\ -2ia_1 + ia_2 + 2ia_3 &= 0, \\ a_1 - a_3 &= 0. \end{aligned}$$

The first determines a_3 (in terms of a_1): $a_3 = a_1$; the second determines a_2 : $a_2 = 0$; and the third is redundant. We may as well pick $a_1 = 1$ (since any multiple of an eigenvector is still an eigenvector):

$$\mathbf{a}^{(1)} = \begin{pmatrix} 1 \\ 0 \\ 1 \end{pmatrix}, \text{ for } \lambda_1 = 0. \quad [3.75]$$

For the second eigenvector (recycling the same notation for the components) we have

$$\begin{pmatrix} 2 & 0 & -2 \\ -2i & i & 2i \\ 1 & 0 & -1 \end{pmatrix} \begin{pmatrix} a_1 \\ a_2 \\ a_3 \end{pmatrix} = 1 \begin{pmatrix} a_1 \\ a_2 \\ a_3 \end{pmatrix} = \begin{pmatrix} a_1 \\ a_2 \\ a_3 \end{pmatrix},$$

which leads to the equations

$$\begin{aligned} 2a_1 - 2a_3 &= a_1, \\ -2ia_1 + ia_2 + 2ia_3 &= a_2, \\ a_1 - a_3 &= a_3, \end{aligned}$$

with the solution $a_3 = (1/2)a_1$, $a_2 = [(1 - i)/2]a_1$; this time we'll pick $a_1 = 2$, so that

$$\mathbf{a}^{(2)} = \begin{pmatrix} 2 \\ (1 - i) \\ 1 \end{pmatrix}, \text{ for } \lambda_2 = 1. \quad [3.76]$$

Finally, for the third eigenvector,

$$\begin{pmatrix} 2 & 0 & -2 \\ -2i & i & 2i \\ 1 & 0 & -1 \end{pmatrix} \begin{pmatrix} a_1 \\ a_2 \\ a_3 \end{pmatrix} = i \begin{pmatrix} a_1 \\ a_2 \\ a_3 \end{pmatrix} = \begin{pmatrix} ia_1 \\ ia_2 \\ ia_3 \end{pmatrix},$$

which gives the equations

$$\begin{aligned} 2a_1 - 2a_3 &= ia_1, \\ -2ia_1 + ia_2 + 2ia_3 &= ia_2, \\ a_1 - a_3 &= ia_3, \end{aligned}$$

whose solution is $a_3 = a_1 = 0$, with a_2 undetermined. Choosing $a_2 = 1$, we conclude

$$\mathbf{a}^{(3)} = \begin{pmatrix} 0 \\ 1 \\ 0 \end{pmatrix}, \text{ for } \lambda_3 = i. \quad [3.77]$$

If the eigenvectors span the space (as they do in the preceding example), we are free to use *them* as a basis:

$$\begin{aligned} \hat{T}|f_1\rangle &= \lambda_1|f_1\rangle, \\ \hat{T}|f_2\rangle &= \lambda_2|f_2\rangle, \\ &\dots \\ \hat{T}|f_n\rangle &= \lambda_n|f_n\rangle. \end{aligned}$$

The matrix representing \hat{T} takes on a very simple form in this basis, with the eigenvalues strung out along the main diagonal and all other elements zero:

$$\mathbf{T} = \begin{pmatrix} \lambda_1 & 0 & \dots & 0 \\ 0 & \lambda_2 & \dots & 0 \\ \vdots & \vdots & & \vdots \\ 0 & 0 & \dots & \lambda_n \end{pmatrix}. \quad [3.78]$$

The (normalized) eigenvectors are equally simple:

$$\mathbf{a}^{(1)} = \begin{pmatrix} 1 \\ 0 \\ 0 \\ \vdots \\ 0 \end{pmatrix}, \quad \mathbf{a}^{(2)} = \begin{pmatrix} 0 \\ 1 \\ 0 \\ \vdots \\ 0 \end{pmatrix}, \quad \dots, \quad \mathbf{a}^{(n)} = \begin{pmatrix} 0 \\ 0 \\ 0 \\ \vdots \\ 1 \end{pmatrix}. \quad [3.79]$$

A matrix that can be brought to **diagonal form** (Equation 3.78) by a change of basis is said to be **diagonalizable**. The similarity matrix that accomplishes the transformation can be constructed by using the eigenvectors (in the old basis) as the columns of \mathbf{S}^{-1} :

$$(\mathbf{S}^{-1})_{ij} = (\mathbf{a}^{(j)})_i. \quad [3.80]$$

Example (cont'd). In the example,

$$\mathbf{S}^{-1} = \begin{pmatrix} 1 & 2 & 0 \\ 0 & (1-i) & 1 \\ 1 & 1 & 0 \end{pmatrix},$$

so (using Equation 3.57)

$$\mathbf{S} = \begin{pmatrix} -1 & 0 & 2 \\ 1 & 0 & -1 \\ (i-1) & 1 & (1-i) \end{pmatrix},$$

and you can check for yourself that

$$\mathbf{SMS}^{-1} = \begin{pmatrix} 0 & 0 & 0 \\ 0 & 1 & 0 \\ 0 & 0 & i \end{pmatrix}.$$

There is a great advantage in bringing a matrix to diagonal form—it's much easier to work with. Unfortunately, not every matrix *can* be diagonalized—the eigenvectors have to span the space. For an example of a matrix that *cannot* be diagonalized, see Problem 3.18.

***Problem 3.17** The 2×2 matrix representing a rotation of the xy -plane is

$$\mathbf{T} = \begin{pmatrix} \cos \theta & -\sin \theta \\ \sin \theta & \cos \theta \end{pmatrix}.$$

Show that (except for certain special angles—what are they?) this matrix has no real eigenvalues. (This reflects the *geometrical* fact that no vector in the plane is carried into itself under such a rotation; contrast rotations in *three* dimensions.) This matrix *does*, however, have *complex* eigenvalues and eigenvectors. Find them. Construct a matrix \mathbf{S} which diagonalizes \mathbf{T} . Perform the similarity transformation (\mathbf{STS}^{-1}) explicitly, and show that it reduces \mathbf{T} to diagonal form.

Problem 3.18 Find the eigenvalues and eigenvectors of the following matrix:

$$\mathbf{M} = \begin{pmatrix} 1 & 1 \\ 0 & 1 \end{pmatrix}.$$

Can this matrix be diagonalized?

Problem 3.19 Show that the first, second, and last coefficients in the characteristic equation (Equation 3.72) are

$$C_n = (-1)^n, \quad C_{n-1} = (-1)^{n-1} \text{Tr}(\mathbf{T}), \quad \text{and} \quad C_0 = \det(\mathbf{T}). \quad [3.81]$$

For a 3×3 matrix with elements T_{ij} , what is C_1 ?

Problem 3.20 It is pretty obvious that the trace of a *diagonal* matrix is the sum of its eigenvalues, and its determinant is their product (see Equation 3.78). It follows (from Equations 3.64 and 3.67) that the same holds for any *diagonalizable* matrix. Prove that

$$\det(\mathbf{T}) = \lambda_1 \lambda_2 \cdots \lambda_n, \quad \text{Tr}(\mathbf{T}) = \lambda_1 + \lambda_2 + \cdots + \lambda_n \quad [3.82]$$

for *any* matrix. (The λ 's are the n solutions to the characteristic equation—in the case of multiple roots, there may be fewer linearly independent *eigenvectors* than there

are solutions, but we still count each λ as many times as it occurs.) *Hint*: Write the characteristic equation in the form

$$(\lambda_1 - \lambda)(\lambda_2 - \lambda) \cdots (\lambda_n - \lambda) = 0,$$

and use the result of Problem 3.19.

3.1.5 Hermitian Transformations

In Equation 3.48 I defined the Hermitian conjugate (or “adjoint”) of a *matrix* as its transpose conjugate: $\mathbf{T}^\dagger = \tilde{\mathbf{T}}^*$. Now I want to give you a more fundamental definition for the Hermitian conjugate of a *linear transformation*: It is that transformation \hat{T}^\dagger which, when applied to the *first* member of an inner product, gives the same result as if \hat{T} itself had been applied to the *second* vector:

$$\langle \hat{T}^\dagger \alpha | \beta \rangle = \langle \alpha | \hat{T} \beta \rangle \quad [3.83]$$

(for all vectors $|\alpha\rangle$ and $|\beta\rangle$).¹³ [I have to warn you that although everybody uses it, this is lousy notation. For α and β are not *vectors* (the *vectors* are $|\alpha\rangle$ and $|\beta\rangle$), they are *labels*—serial numbers (“F43A-9GT”), or names (“Charlie”), or bar codes—anything you care to use to identify the different vectors. In particular, they are endowed with no mathematical properties at all, and the expression “ $\hat{T}\beta$ ” is literally *nonsense*: linear transformations act on *vectors*, not *labels*. But it’s pretty clear what the notation *means*: $|\hat{T}\beta\rangle$ means $\hat{T}|\beta\rangle$, and $\langle \hat{T}^\dagger \alpha | \beta \rangle$ means the inner product of the vector $\hat{T}^\dagger|\alpha\rangle$ with the vector $|\beta\rangle$. Notice in particular that

$$\langle \alpha | c\beta \rangle = c\langle \alpha | \beta \rangle, \quad [3.84]$$

but

$$\langle c\alpha | \beta \rangle = c^* \langle \alpha | \beta \rangle \quad [3.85]$$

for any scalar c .] If you’re working in an orthonormal basis (as we always shall), the Hermitian conjugate of a linear transformation is represented by the Hermitian conjugate of the corresponding matrix (so the terminology is consistent); for (using Equations 3.50 and 3.53),

$$\langle \alpha | \hat{T} \beta \rangle = \mathbf{a}^\dagger \mathbf{T} \mathbf{b} = (\mathbf{T}^\dagger \mathbf{a})^\dagger \mathbf{b} = \langle \hat{T}^\dagger \alpha | \beta \rangle. \quad [3.86]$$

In quantum mechanics, a fundamental role is played by Hermitian transformations ($\hat{T}^\dagger = \hat{T}$). The eigenvectors and eigenvalues of a Hermitian transformation have three crucial properties:

¹³If you’re wondering whether such a transformation necessarily *exists*, you should have been a math major. Still, it’s a good question, and the answer is yes. See, for instance, Halmos, (footnote 1), Section 44.

1. The eigenvalues of a Hermitian transformation are real.

Proof: Let λ be an eigenvalue of \hat{T} : $\hat{T}|\alpha\rangle = \lambda|\alpha\rangle$, with $|\alpha\rangle \neq |0\rangle$. Then

$$\langle\alpha|\hat{T}\alpha\rangle = \langle\alpha|\lambda\alpha\rangle = \lambda\langle\alpha|\alpha\rangle.$$

Meanwhile, if \hat{T} is Hermitian, then

$$\langle\alpha|\hat{T}\alpha\rangle = \langle\hat{T}\alpha|\alpha\rangle = \langle\lambda\alpha|\alpha\rangle = \lambda^*\langle\alpha|\alpha\rangle.$$

But $\langle\alpha|\alpha\rangle \neq 0$ (Equation 3.20), so $\lambda = \lambda^*$, and hence λ is real. QED

2. The eigenvectors of a Hermitian transformation belonging to distinct eigenvalues are orthogonal.

Proof: Suppose $\hat{T}|\alpha\rangle = \lambda|\alpha\rangle$ and $\hat{T}|\beta\rangle = \mu|\beta\rangle$, with $\lambda \neq \mu$. Then

$$\langle\alpha|\hat{T}\beta\rangle = \langle\alpha|\mu\beta\rangle = \mu\langle\alpha|\beta\rangle,$$

and if \hat{T} is Hermitian,

$$\langle\alpha|\hat{T}\beta\rangle = \langle\hat{T}\alpha|\beta\rangle = \langle\lambda\alpha|\beta\rangle = \lambda^*\langle\alpha|\beta\rangle.$$

But $\lambda = \lambda^*$ (from property 1), and $\lambda \neq \mu$, by assumption, so $\langle\alpha|\beta\rangle = 0$. QED

3. The eigenvectors of a Hermitian transformation span the space.

Comment: If all the n roots of the characteristic equation are distinct, then (by property 2) we have n mutually orthogonal eigenvectors, so they *obviously* span the space. But what if there are duplicate roots (or, as they are called, in this context, **degenerate** eigenvalues)? Suppose λ is m -fold degenerate; any *linear combination* of two eigenvectors belonging to the same eigenvalue is still an eigenvector (with the same eigenvalue)—what we must show is that there are m *linearly independent* eigenvectors with eigenvalue λ . The proof is given in most books on linear algebra,¹⁴ and I shall not repeat it here. These eigenvectors can be orthogonalized by the Gram-Schmidt procedure (see Problem 3.4), so in fact the eigenvectors of a Hermitian transformation can always be taken to constitute an orthonormal basis. It follows, in particular, that *any Hermitian matrix can be diagonalized by a similarity transformation, with S unitary*. This rather technical result is, in a sense, the mathematical support on which much of quantum mechanics leans. As we shall see, it turns out to be a thinner reed than one might have hoped.

¹⁴I like the treatment in F. W. Byron, Jr., and R. W. Fuller, *Mathematics of Classical and Quantum Physics* (Reading, MA: Addison-Wesley, 1969), Vol. I, Section 4.7.

Problem 3.21 A Hermitian linear transformation must satisfy $\langle \alpha | \hat{T} \beta \rangle = \langle \hat{T} \alpha | \beta \rangle$ for all vectors $|\alpha\rangle$ and $|\beta\rangle$. Prove that it is (surprisingly) sufficient that $\langle \gamma | \hat{T} \gamma \rangle = \langle \hat{T} \gamma | \gamma \rangle$ for all vectors $|\gamma\rangle$. Suppose you could show that $\langle e_n | \hat{T} e_n \rangle = \langle \hat{T} e_n | e_n \rangle$ for every member of an orthonormal basis. Does it necessarily follow that \hat{T} is Hermitian? *Hint:* First let $|\gamma\rangle = |\alpha\rangle + |\beta\rangle$, and then let $|\gamma\rangle = |\alpha\rangle + i|\beta\rangle$.

***Problem 3.22** Let

$$\mathbf{T} = \begin{pmatrix} 1 & 1 - i \\ 1 + i & 0 \end{pmatrix}.$$

- (a) Verify that \mathbf{T} is Hermitian.
 - (b) Find its eigenvalues (note that they are real).
 - (c) Find and normalize the eigenvectors (note that they are orthogonal).
 - (d) Construct the unitary diagonalizing matrix \mathbf{S} , and check explicitly that it diagonalizes \mathbf{T} .
 - (e) Check that $\det(\mathbf{T})$ and $\text{Tr}(\mathbf{T})$ are the same for \mathbf{T} as they are for its diagonalized form.
-

****Problem 3.23** Consider the following Hermitian matrix:

$$\mathbf{T} = \begin{pmatrix} 2 & i & 1 \\ -i & 2 & i \\ 1 & -i & 2 \end{pmatrix}.$$

- (a) Calculate $\det(\mathbf{T})$ and $\text{Tr}(\mathbf{T})$.
 - (b) Find the eigenvalues of \mathbf{T} . Check that their sum and product are consistent with (a), in the sense of Equation 3.82. Write down the diagonalized version of \mathbf{T} .
 - (c) Find the eigenvectors of \mathbf{T} . Within the degenerate sector, construct two linearly independent eigenvectors (it is this step that is always possible for a *Hermitian* matrix, but not for an *arbitrary* matrix—contrast Problem 3.18). Orthogonalize them, and check that both are orthogonal to the third. Normalize all three eigenvectors.
 - (d) Construct the unitary matrix \mathbf{S} that diagonalizes \mathbf{T} , and show explicitly that the similarity transformation using \mathbf{S} reduces \mathbf{T} to the appropriate diagonal form.
-

Problem 3.24 A *unitary* linear transformation is one for which $\hat{U}^\dagger \hat{U} = 1$.

- (a) Show that unitary transformations preserve inner products, in the sense that $\langle \hat{U}\alpha | \hat{U}\beta \rangle = \langle \alpha | \beta \rangle$, for all vectors $|\alpha\rangle, |\beta\rangle$.

- (b) Show that the eigenvalues of a unitary transformation have modulus 1.
- (c) Show that the eigenvectors of a unitary transformation belonging to distinct eigenvalues are orthogonal.

3.2 FUNCTION SPACES

We are ready now to apply the machinery of linear algebra to the interesting and important case of **function spaces**, in which the “vectors” are (complex) functions of x , inner products are integrals, and derivatives appear as linear transformations.

3.2.1 Functions as Vectors

Do functions really behave as vectors? Well, is the sum of two functions a function? Sure. Is addition of functions commutative and associative? Indeed. Is there a “null” function? Yes: $f(x) \equiv 0$. If you multiply a function by a complex number, do you get another function? Of course. Now, the set of *all* functions is a bit unwieldy—we’ll be concerned with special *classes* of functions, such as the set of all polynomials of degree $< N$ (Problem 3.2), or the set of all odd functions that go to zero at $x = 1$, or the set of all periodic functions with period π . Of course, when you start imposing conditions like this, you’ve got to make sure that you still meet the requirements for a vector space. For example, the set of all functions whose maximum value is 3 would *not* constitute a vector space (multiplication by 2 would give you functions with maximum value 6, which are outside the space).

The inner product of two functions [$f(x)$ and $g(x)$] is defined by the integral

$$\langle f|g \rangle = \int f(x)^* g(x) dx \tag{3.87}$$

(the limits will depend on the domain of the functions in question). You can check for yourself that it satisfies the three conditions (Equations 3.19, 3.20, and 3.21) for an inner product. Of course, this integral may not *converge*, so if we want a function space with an inner product, we must restrict the class of functions so as to ensure that $\langle f|g \rangle$ is always well defined. It is clearly *necessary* that every admissible function be **square integrable**:

$$\int |f(x)|^2 dx < \infty \tag{3.88}$$

(otherwise the inner product of f with *itself* wouldn’t even exist). As it turns out,

Table 3.1: The first few Legendre polynomials, $P_n(x)$.

| |
|--|
| $P_0 = 1$ |
| $P_1 = x$ |
| $P_2 = \frac{1}{2}(3x^2 - 1)$ |
| $P_3 = \frac{1}{2}(5x^3 - 3x)$ |
| $P_4 = \frac{1}{8}(35x^4 - 30x^2 + 3)$ |
| $P_5 = \frac{1}{8}(63x^5 - 70x^3 + 15x)$ |

this restriction is also *sufficient*—if f and g are both square integrable, then the integral in Equation 3.87 is necessarily finite.¹⁵

For example, consider the set $P(N)$ of all *polynomials* of degree $< N$:

$$p(x) = a_0 + a_1x + a_2x^2 + \cdots + a_{N-1}x^{N-1}, \quad [3.89]$$

on the interval $-1 \leq x \leq 1$. They are certainly square integrable, so this is a bona fide inner product space. An obvious basis is the set of powers of x :

$$|e_1\rangle = 1, \quad |e_2\rangle = x, \quad |e_3\rangle = x^2, \quad \dots, \quad |e_N\rangle = x^{N-1}; \quad [3.90]$$

evidently it's an N -dimensional vector space. This is *not*, however, an *orthonormal* basis, for

$$\langle e_1|e_1\rangle = \int_{-1}^1 1 \, dx = 2, \quad \langle e_1|e_3\rangle = \int_{-1}^1 x^2 \, dx = 2/3,$$

and so on. If you apply the Gram-Schmidt procedure, to orthonormalize this basis (Problem 3.25), you get the famous **Legendre polynomials**, $P_n(x)$ (except that Legendre, who had other things on his mind, didn't normalize them properly):

$$|e'_n\rangle = \sqrt{n - (1/2)} P_{n-1}(x), \quad (n = 1, 2, \dots, N). \quad [3.91]$$

In Table 3.1 I have listed the first few Legendre polynomials.

***Problem 3.25** Orthonormalize the powers of x , on the interval $-1 \leq x \leq 1$, to obtain the first four Legendre polynomials (Equation 3.91).

***Problem 3.26** Let $T(N)$ be the set of all trigonometric functions of the form

$$f(x) = \sum_{n=0}^{N-1} [a_n \sin(n\pi x) + b_n \cos(n\pi x)], \quad [3.92]$$

¹⁵There is a quick phoney "proof" of this, based on the Schwarz inequality (Equation 3.27). The trouble is, we *assumed* the existence of the inner product in proving the Schwarz inequality (Problem 3.5), so the logic is circular. For a legitimate proof, see F. Riesz and B. Sz.-Nagy, *Functional Analysis* (New York: Unger, 1955), Section 21.

on the interval $-1 \leq x \leq 1$. Show that

$$|e_n\rangle = \frac{1}{\sqrt{2}} e^{in\pi x}, \quad (n = 0, \pm 1, \dots, \pm(N-1)) \quad [3.93]$$

constitutes an orthonormal basis. What is the dimension of this space?

Problem 3.27 Consider the set of all functions of the form $p(x)e^{-x^2/2}$, where $p(x)$ is again a polynomial of degree $< N$ in x , on the interval $-\infty < x < \infty$. Check that they constitute an inner product space. The “natural” basis is

$$|e_1\rangle = e^{-x^2/2}, |e_2\rangle = xe^{-x^2/2}, |e_3\rangle = x^2e^{-x^2/2}, \dots, |e_N\rangle = x^{N-1}e^{-x^2/2}.$$

Orthonormalize the first four of these, and comment on the result.

3.2.2 Operators as Linear Transformations

In function spaces *operators* (such as d/dx , d^2/dx^2 , or simply x) behave as linear transformations, provided that they carry functions in the space into other functions in the space and satisfy the linearity condition (Equation 3.29). For example, in the polynomial space $P(N)$ the derivative operator ($\hat{D} \equiv d/dx$) is a linear transformation, but the operator \hat{x} (multiplication by x)¹⁶ is *not*, for it takes $(N-1)$ th-order polynomials into N th-order polynomials, which are no longer in the space.

In a function space, the eigenvectors of an operator \hat{T} are called **eigenfunctions**:

$$\hat{T}f(x) = \lambda f(x). \quad [3.94]$$

For example, the eigenfunctions of \hat{D} are

$$f_\lambda(x) = Ae^{\lambda x}. \quad [3.95]$$

Evidently this operator has only *one* eigenfunction (the one with $\lambda = 0$) in the space $P(N)$.

A Hermitian operator is one that satisfies the defining condition (Equation 3.83):

$$\langle f | \hat{T}g \rangle = \langle \hat{T}f | g \rangle, \quad [3.96]$$

for all functions $f(x)$ and $g(x)$ in the space. Is the derivative operator Hermitian? Well, using integration by parts, we get

$$\langle f | \hat{D}g \rangle = \int_a^b f^* \frac{dg}{dx} dx = (f^*g)|_a^b - \int_a^b \frac{df^*}{dx} g dx = (f^*g)|_a^b - \langle \hat{D}f | g \rangle. \quad [3.97]$$

¹⁶For consistency, I'll put a hat on x when I'm emphasizing its role as an operator, but you're welcome to ignore it if you think I'm being too fastidious.

It's *close*, but the sign is wrong, and there's an unwanted boundary term. The sign is easily disposed of: \hat{D} itself is (except for the boundary term) *skew* Hermitian, so $i\hat{D}$ would be Hermitian—complex conjugation of the i compensates for the minus sign coming from integration by parts. As for the boundary term, it will go away if we restrict ourselves to functions which have the same value at the two ends:

$$f(b) = f(a). \quad [3.98]$$

In practice, we shall almost always be working on the *infinite* interval ($a = -\infty$, $b = +\infty$), where square integrability (Equation 3.88) guarantees that $f(a) = f(b) = 0$, and hence that $i\hat{D}$ is Hermitian. But $i\hat{D}$ is *not* Hermitian in the polynomial space $P(N)$.

By now you will realize that when dealing with operators you must always keep in mind the function space you're working in—an innocent-looking operator may not be a legitimate linear transformation, because it carries functions out of the space; the eigenfunctions of an operator may not reside in the space; and an operator that's Hermitian in one space may *not* be Hermitian in another. However, these are relatively harmless problems—they can startle you, if you're not expecting them, but they don't bite. A much more dangerous snake is lurking here, but it only inhabits vector spaces of infinite dimension. I noted a moment ago that \hat{x} is not a linear transformation in the space $P(N)$ (multiplication by x increases the order of the polynomial and hence takes functions outside the space). However, it *is* a linear transformation on $P(\infty)$, the space of *all* polynomials on the interval $-1 \leq x \leq 1$. In fact, it's a *Hermitian* transformation, since (obviously)

$$\int_{-1}^1 [f(x)]^* [xg(x)] dx = \int_{-1}^1 [xf(x)]^* [g(x)] dx.$$

But what are its eigenfunctions? Well,

$$x(a_0 + a_1x + a_2x^2 + \dots) = \lambda(a_0 + a_1x + a_2x^2 + \dots),$$

for all x , means

$$\begin{aligned} 0 &= \lambda a_0, \\ a_0 &= \lambda a_1, \\ a_1 &= \lambda a_2, \end{aligned}$$

and so on. If $\lambda = 0$, then all the components are zero, and that's not a legal eigenvector; but if $\lambda \neq 0$, the first equation says $a_0 = 0$, so the second gives $a_1 = 0$, and the third says $a_2 = 0$, and so on, and we're back in the same bind. *This* Hermitian operator doesn't have a complete set of eigenfunctions—in fact it doesn't have *any at all!* Not, at any rate, in $P(\infty)$.

What *would* an eigenfunction of \hat{x} look like? If

$$xg(x) = \lambda g(x), \quad [3.99]$$

where λ , remember, is a constant, then everywhere *except* at the one point $x = \lambda$ we must have $g(x) = 0$. Evidently the eigenfunctions of \hat{x} are Dirac delta functions:

$$g_\lambda(x) = B\delta(x - \lambda), \tag{3.100}$$

and since delta functions are certainly not polynomials, it is no wonder that the operator \hat{x} has no eigenfunctions in $P(\infty)$.

The moral of the story is that whereas the first two theorems in Section 3.1.5 are completely general (the eigenvalues of a Hermitian operator are real, and the eigenvectors belonging to different eigenvalues are orthogonal), the third one (completeness of the eigenvectors) is valid (in general) only for finite-dimensional spaces. In infinite-dimensional spaces some Hermitian operators have complete sets of eigenvectors (see Problem 3.32d for an example), some have *incomplete* sets, and some (as we just saw) have no eigenvectors (in the space) at all.¹⁷ Unfortunately, the completeness property is absolutely essential in quantum mechanical applications. In Section 3.3 I'll show you how we manage this problem.

Problem 3.28 Show that $\exp(-x^2/2)$ is an eigenfunction of the operator $\hat{Q} = (d^2/dx^2) - x^2$, and find its eigenvalue.

***Problem 3.29**

- (a) Construct the matrix **D** representing the derivative operator $\hat{D} = d/dx$ with respect to the (nonorthonormal) basis (Equation 3.90) in $P(N)$.
- (b) Construct the matrix representing \hat{D} with respect to the (orthonormal) basis (Equation 3.93) in the space $T(N)$ of Problem 3.26.
- (c) Construct the matrix **X** representing the operator $\hat{x} = x$ with respect to the basis (Equation 3.90) in $P(\infty)$. If this is a Hermitian operator (and it *is*), how come the matrix is not equal to its transpose conjugate?

****Problem 3.30** Construct the matrices **D** and **X** in the (orthonormal) basis (Equation 3.91) for $P(\infty)$. You will need to use two recursion formulas for Legendre polynomials:

$$xP_n(x) = \frac{1}{(2n+1)} [(n+1)P_{n+1}(x) + nP_{n-1}(x)]; \tag{3.101}$$

$$\frac{dP_n}{dx} = \sum_{k=0}^{n-1} (2n-4k-1)P_{n-2k-1}(x), \tag{3.102}$$

¹⁷In an n -dimensional vector space, every linear transformation can be represented (with respect to a particular basis) by an $n \times n$ matrix, and as long as n is finite, the characteristic Equation 3.71 is guaranteed to deliver at least one eigenvalue. But if n is *infinite*, we can't take the determinant, there is no characteristic equation, and hence there is no assurance that even a *single* eigenvector exists.

where the sum cuts off at the first term with a negative index. Confirm that \mathbf{X} is Hermitian but $i\mathbf{D}$ is not.

Problem 3.31 Consider the operator $\hat{D}^2 = d^2/dx^2$. Under what conditions (on the admissible functions) is it a Hermitian operator? Construct the matrix representing \hat{D}^2 in $P(N)$ (with respect to the basis Equation 3.90), and confirm that it is the square of the matrix representing \hat{D} (Problem 3.29a).

Problem 3.32

- (a) Show that $i\hat{D}$ is Hermitian in the space $T(N)$ of Problem 3.26.
 - (b) What are its eigenvalues and (normalized) eigenfunctions, in $T(N)$?
 - (c) Check that your results in (b) satisfy the three theorems in Section 3.1.5.
 - (d) Confirm that $i\hat{D}$ has a complete set of eigenfunctions in $T(\infty)$ (quote the pertinent theorem from Fourier analysis).
-

3.2.3 Hilbert Space

To construct the real number system, mathematicians typically begin with the *integers*, and use them to define the *rationals* (ratios of integers). They proceed to show that the rational numbers are “dense,” in the sense that between any two of them (no matter how close together they are) you can always find another one (in fact, infinitely many of them). And yet, the set of all rational numbers has “gaps” in it, for you can easily think of infinite *sequences* of rational numbers whose *limit* is *not* a rational number. For example,

$$A_N = 1 - \frac{1}{2} + \frac{1}{3} - \frac{1}{4} + \cdots \pm \frac{1}{N} \quad [3.103]$$

is a rational number for any finite integer N , but its limit (as $N \rightarrow \infty$) is $\ln 2$, which is *not* a rational number. So the final step in constructing the real numbers is to “fill in the gaps”, or “complete” the set, by including the limits of all convergent sequences of rational numbers. (Of course, some sequences don’t *have* limits, and those we do not include. For example, if you change the minus signs in Equation 3.103 to plus signs, the sequence does not converge, and it doesn’t correspond to *any* real number.)

The same thing happens with function spaces. For example, the set of all polynomials, $P(\infty)$, includes functions of the form

$$f_N(x) = 1 + x + \frac{x^2}{2} + \frac{x^3}{3!} + \frac{x^4}{4!} + \cdots + \frac{x^N}{N!} \quad [3.104]$$

(for finite N), but it does *not* include the limit as $N \rightarrow \infty$:

$$1 + x + \frac{x^2}{2} + \frac{x^3}{3!} + \cdots = \sum_{n=0}^{\infty} \frac{x^n}{n!} = e^x. \quad [3.105]$$

For e^x is not itself a polynomial, although it is the limit of a *sequence* of polynomials. To *complete* the space, we would like to include all such functions. Of course, some sequences of polynomials don't have limits, or have them only for a restricted range of x . For example, the series

$$1 + x + x^2 + x^3 + \dots = \frac{1}{1 - x}$$

converges only for $|x| < 1$. And even if the sequence does have a limit, the limit function may not be square integrable, so we can't include it in an inner product space. To complete the space, then, we throw in all square-integrable convergent sequences of functions in the space. Notice that completing a space does not involve the introduction of any new basis vectors; it is just that we now allow linear combinations involving an infinite number of terms,

$$|\alpha\rangle = \sum_{j=1}^{\infty} a_j |e_j\rangle, \tag{3.106}$$

provided $\langle\alpha|\alpha\rangle$ is finite—which is to say (if the basis is orthonormal), provided

$$\sum_{j=1}^{\infty} |a_j|^2 < \infty. \tag{3.107}$$

A **complete**¹⁸ inner product space is called a **Hilbert space**.¹⁹ The completion of $P(\infty)$ is easy to characterize: It is nothing less than the set of *all* square-integrable functions on the interval $-1 < x < +1$; we call it $L_2(-1, +1)$. More generally, the set of all square-integrable functions on the interval $a < x < b$ is $L_2(a, b)$. We shall be concerned primarily with the Hilbert space $L_2(-\infty, +\infty)$ (or L_2 , for short), because this is where quantum mechanical wave functions live. Indeed, to physicists L_2 is practically synonymous with “Hilbert space”.

The eigenfunctions of the Hermitian operators $i\hat{D} = id/dx$ and $\hat{x} = x$ are of particular importance. As we have already found (Equations 3.95 and 3.100), they take the form

$$f_\lambda(x) = A_\lambda e^{-i\lambda x}, \quad \text{and} \quad g_\lambda(x) = B_\lambda \delta(x - \lambda),$$

respectively. Note that there is no restriction on the eigenvalues—*every* real number is an eigenvalue of $i\hat{D}$, and *every* real number is an eigenvalue of \hat{x} . The set of all eigenvalues of a given operator is called its **spectrum**; $i\hat{D}$ and \hat{x} are operators with **continuous spectra**, in contrast to the **discrete spectra** we have encountered

¹⁸Note the two entirely different uses of the word “complete”: a *set of vectors* is complete if it spans the space; an *inner product space* is complete if it has no “holes” in it (i.e., it includes all its limits).

¹⁹Every finite-dimensional inner product space is trivially complete, so they're all technically Hilbert spaces, but the term is usually reserved for *infinite*-dimensional spaces.

heretofore. Unfortunately, these eigenfunctions *do not lie in Hilbert space*, and hence, in the strictest sense, do not count as vectors at all. For neither of them is square-integrable:

$$\int_{-\infty}^{\infty} f_{\lambda}(x)^* f_{\lambda}(x) dx = |A_{\lambda}|^2 \int_{-\infty}^{\infty} e^{i\lambda x} e^{-i\lambda x} dx = |A_{\lambda}|^2 \int_{-\infty}^{\infty} 1 dx \rightarrow \infty,$$

and

$$\int_{-\infty}^{\infty} g_{\lambda}(x)^* g_{\lambda}(x) dx = |B_{\lambda}|^2 \int_{-\infty}^{\infty} \delta(x - \lambda) \delta(x - \lambda) dx = |B_{\lambda}|^2 \delta(\lambda - \lambda) \rightarrow \infty.$$

Nevertheless, they do satisfy a kind of orthogonality condition:

$$\int_{-\infty}^{\infty} f_{\lambda}(x)^* f_{\mu}(x) dx = A_{\lambda}^* A_{\mu} \int_{-\infty}^{\infty} e^{i\lambda x} e^{-i\mu x} dx = |A_{\lambda}|^2 2\pi \delta(\lambda - \mu)$$

(see Equation 2.126), and

$$\int_{-\infty}^{\infty} g_{\lambda}(x)^* g_{\mu}(x) dx = B_{\lambda}^* B_{\mu} \int_{-\infty}^{\infty} \delta(x - \lambda) \delta(x - \mu) dx = |B_{\lambda}|^2 \delta(\lambda - \mu).$$

It is customary to “normalize” these (unnormalizable) functions by picking the constant so as to leave an unadorned Dirac delta function on the right side (replacing the *Kronecker* delta in the usual orthonormality condition; Equation 3.23).²⁰ Thus

$$f_{\lambda}(x) = \frac{1}{\sqrt{2\pi}} e^{-i\lambda x}, \quad \text{with } \langle f_{\lambda} | f_{\mu} \rangle = \delta(\lambda - \mu), \quad [3.108]$$

are the “normalized” eigenfunctions of $i\hat{D}$, and

$$g_{\lambda}(x) = \delta(x - \lambda), \quad \text{with } \langle g_{\lambda} | g_{\mu} \rangle = \delta(\lambda - \mu), \quad [3.109]$$

are the “normalized” eigenfunctions of \hat{x} .²¹

What if we use the “normalized” eigenfunctions of $i\hat{D}$ and \hat{x} as bases for L_2 ?²² Because the spectrum is continuous, the linear combination becomes an integral:

$$|f\rangle = \int_{-\infty}^{\infty} a_{\lambda} |f_{\lambda}\rangle d\lambda; \quad |f\rangle = \int_{-\infty}^{\infty} b_{\lambda} |g_{\lambda}\rangle d\lambda. \quad [3.110]$$

²⁰I’ll call this “normalization” (in quotes) so you won’t confuse it with the real thing.

²¹We are engaged here in a dangerous stretching of the rules, pioneered by Dirac (who had a kind of inspired confidence that he could get away with it) and disparaged by von Neumann (who was more sensitive to mathematical niceties), in their rival classics (P. A. M. Dirac, *The Principles of Quantum Mechanics*, first published in 1930, 4th ed., Oxford (Clarendon Press) 1958, and J. von Neumann, *The Mathematical Foundations of Quantum Mechanics*, first published in 1932, revised by Princeton Univ. Press, 1955). **Dirac notation** invites us to apply the language and methods of linear algebra to functions that lie in the “almost normalizable” suburbs of Hilbert space. It turns out to be powerful and effective beyond any reasonable expectation.

²²That’s right: We’re going to use, as bases, sets of functions none of which is actually in the space! They may not be normalizable, but they *are* complete, and that’s all we need.

Taking the inner product with $|f_\mu\rangle$, and exploiting the “orthonormality” of the basis (Equation 3.108), we obtain the “components” a_λ :

$$\langle f_\mu | f \rangle = \int_{-\infty}^{\infty} a_\lambda \langle f_\mu | f_\lambda \rangle d\lambda = \int_{-\infty}^{\infty} a_\lambda \delta(\mu - \lambda) d\lambda = a_\mu.$$

So

$$a_\lambda = \langle f_\lambda | f \rangle = \frac{1}{\sqrt{2\pi}} \int_{-\infty}^{\infty} e^{i\lambda x} f(x) dx = F(-\lambda); \quad [3.111]$$

evidently the $-\lambda$ “component” of the vector $|f\rangle$, in the basis of eigenfunctions of $i\hat{D}$, is the *Fourier transform* (Equation 2.85) of the function $f(x)$. Likewise,

$$b_\lambda = \langle g_\lambda | f \rangle = \int_{-\infty}^{\infty} \delta(x - \lambda) f(x) dx = f(\lambda), \quad [3.112]$$

so the λ “component” of the vector $|f\rangle$ in the *position* basis is $f(\lambda)$ itself. [If that sounds like double-talk, remember that $|f\rangle$ is an abstract vector, which can be expressed with respect to any basis you like; in this sense the *function* $f(x)$ is merely the collection of its “components” in the particular basis consisting of eigenvectors of the position operator.] Meanwhile, we can no longer represent operators by matrices because the basis vectors are labeled by a nondenumerable index. Nevertheless, we are still interested in quantities of the form

$$\langle f_\lambda | \hat{T} | f_\mu \rangle,$$

which, by force of habit, we shall call the λ, μ **matrix element** of the operator \hat{T} .

****Problem 3.33**

- (a) Show that any linear combination of two functions in $L_2(a, b)$ is still in $L_2(a, b)$. If this *weren't* true, of course, $L_2(a, b)$ wouldn't be a vector space at all.
- (b) For what range of (real) ν is the function $f(x) = |x|^\nu$ in $L_2(-1, +1)$?
- (c) For what range of a is the function $f(x) = 1 - x + x^2 - x^3 + \dots$ in $L_2(-a, +a)$?
- (d) Show that the function $f(x) = e^{-|x|}$ is in L_2 , and find its “components” in the basis (Equation 3.108).
- (e) Find the matrix elements of the operator \hat{D}^2 with respect to the basis (Equation 3.108) of L_2 .

Problem 3.34 $L_2(-1, +1)$ includes *discontinuous* functions [such as the step function, $\theta(x)$, Equation [2.125], which are not differentiable. But functions expressible as Taylor series ($f(x) = a_0 + a_1x + a_2x^2 + \dots$) must be *infinitely* differentiable. How, then, can $\theta(x)$ be the limit of a sequence of polynomials? *Note:* This is not a difficult problem, once you see the light, but it is very subtle, so don't waste a lot of time on it if you're not getting anywhere.

3.3 THE GENERALIZED STATISTICAL INTERPRETATION

My next project is to recast the fundamental principles of quantum mechanics (as developed in Chapters 1 and 2) into the more elegant language of linear algebra. Remember that the state of a particle is represented by its wave function, $\Psi(x, t)$, whose absolute square is the probability density for finding the particle at point x , at time t . It follows that Ψ must be *normalized*, which is possible (by dividing off a constant) if and only if it is square integrable. Thus

1. The state of a particle is represented by a normalized vector ($|\Psi\rangle$) in the Hilbert space L_2 .

Classical dynamical quantities (such as position, velocity, momentum and kinetic energy) can be expressed as functions of the “canonical” variables x and p (and, in rare cases, t): $Q(x, p, t)$. To each such classical observable we associate a quantum-mechanical *operator*, \hat{Q} , obtained from Q by the substitution

$$p \rightarrow \frac{\hbar}{i} \frac{\partial}{\partial x}. \quad [3.113]$$

The expectation value of Q , in the state Ψ , is

$$\langle Q \rangle = \int \Psi(x, t)^* \hat{Q} \Psi(x, t) dx,$$

which we now write as an inner product:²³

$$\langle Q \rangle = \langle \Psi | \hat{Q} \Psi \rangle. \quad [3.114]$$

Now, the expectation value of an observable quantity has got to be a *real* number (after all, it corresponds to actual measurements in the laboratory, using rulers and clocks and meters), so

$$\langle \Psi | \hat{Q} \Psi \rangle = \langle \Psi | \hat{Q} \Psi \rangle^* = \langle \hat{Q} \Psi | \Psi \rangle, \quad [3.115]$$

for all vectors $|\Psi\rangle$. It follows (see Problem 3.21) that \hat{Q} must be a *Hermitian* operator. Thus

2. Observable quantities, $Q(x, p, t)$, are represented by Hermitian operators, $\hat{Q}(x, \frac{\hbar}{i} \frac{\partial}{\partial x}, t)$; the expectation value of Q , in the state $|\Psi\rangle$, is $\langle \Psi | \hat{Q} \Psi \rangle$.

²³The “lousy notation” I warned you about on page 92 is not so bad in this context, for we are using the function Ψ *itself* to label the vector $|\Psi\rangle$, and the expression $\hat{Q}\Psi$ is perfectly self-explanatory.

In general, identical measurements on identically prepared systems (all in the same state Ψ) do not yield reproducible results; however, *some* states are **determinate**, for a particular observable, in the sense that they always give the same result. [A competent measurement of the total energy of a particle in the ground state of the harmonic oscillator, for example, will always return the value $(1/2)\hbar\omega$.] For a determinate state of observable Q , the standard deviation is zero:

$$\begin{aligned} 0 = \sigma_Q^2 &= \langle (\hat{Q} - \langle Q \rangle)^2 \rangle = \langle \Psi | (\hat{Q} - \langle Q \rangle)^2 \Psi \rangle \\ &= \langle (\hat{Q} - \langle Q \rangle) \Psi | (\hat{Q} - \langle Q \rangle) \Psi \rangle = \| (\hat{Q} - \langle Q \rangle) \Psi \|^2. \end{aligned} \quad [3.116]$$

[I used the fact that the operator $(\hat{Q} - \langle Q \rangle)$ is Hermitian to peel it off the second member of the inner product and attach it to the first member.] But the only vector with norm zero is the *null* vector (Equation 3.20), so $(\hat{Q} - \langle Q \rangle) \Psi = 0$, or

$$\hat{Q} \Psi = \langle Q \rangle \Psi. \quad [3.117]$$

Evidently determinate states are *eigenvectors* of \hat{Q} . Thus

3. A measurement of the observable Q on a particle in the state $|\Psi\rangle$ is certain to return the value λ if and only if $|\Psi\rangle$ is an eigenvector of \hat{Q} , with eigenvalue λ .

For example, the time-independent Schrödinger equation (Equation 2.11),

$$\hat{H}\psi = E\psi,$$

is nothing but an eigenvalue equation for the Hamiltonian operator, and the solutions are states of determinate energy (as we noted long ago).

Up to this point I have added nothing *new* to the statistical interpretation; I have merely explored its implications in the language of linear algebra. But there is a missing part to the story: Although we can calculate the *average* result of any measurement, we still cannot say what the probability of getting a *particular* result would be if we were to measure a given observable Q on a particle in an arbitrary state $|\Psi\rangle$ (except for the special case of *position* for which the original statistical interpretation supplies the answer). To finish the job, we need the following **generalized statistical interpretation**, which is inspired by postulate 3 above, and subsumes it as a special case:

3'. If you measure an observable Q on a particle in the state $|\Psi\rangle$, you are certain to get one of the eigenvalues of \hat{Q} . The probability of getting the particular eigenvalue λ is equal to the absolute square of the λ component of $|\Psi\rangle$, when expressed in the orthonormal basis of eigenvectors.²⁴

²⁴Notice that we could calculate from this the expectation value of Q , and it is important to check that the result is consistent with postulate 2 above. See Problem 3.35(c).

To sustain this postulate, it is essential that the eigenfunctions of \hat{Q} span the space. As we have seen, in the *finite*-dimensional case the eigenvectors of a Hermitian operator *always* span the space. But this theorem fails in the infinite-dimensional case—we have encountered examples of Hermitian operators that have no eigenfunctions at all, or for which the eigenfunctions lie outside the Hilbert space. *We shall take it as a restriction on the subset of Hermitian operators that are **observable**, that their eigenfunctions constitute a complete set* (though they need not fall inside L_2).²⁵

Now, there are two kinds of eigenvectors, which we need to treat separately. If the spectrum is *discrete* (with the distinct eigenvalues separated by finite gaps), we can label the eigenvectors with an integer n :

$$\hat{Q}|e_n\rangle = \lambda_n|e_n\rangle, \quad \text{with } n = 1, 2, 3, \dots; \quad [3.118]$$

the eigenvectors are orthonormal (or rather, they can always be *chosen* so):

$$\langle e_n|e_m\rangle = \delta_{nm}; \quad [3.119]$$

the completeness relation takes the form of a *sum*:

$$|\Psi\rangle = \sum_{n=1}^{\infty} c_n|e_n\rangle; \quad [3.120]$$

the components are given by “Fourier’s trick”:

$$c_n = \langle e_n|\Psi\rangle, \quad [3.121]$$

and the probability of getting the particular eigenvalue λ_n is

$$|c_n|^2 = |\langle e_n|\Psi\rangle|^2. \quad [3.122]$$

On the other hand, if the spectrum is *continuous*, the eigenvectors are labeled by a continuous variable (k):

$$\hat{Q}|e_k\rangle = \lambda_k|e_k\rangle, \quad \text{with } -\infty < k < \infty; \quad [3.123]$$

the eigenfunctions are *not* normalizable (so they do not lie in L_2 , and do not themselves represent possible particle states), but they satisfy a sort of “orthonormality” condition

$$\langle e_k|e_l\rangle = \delta(k-l) \quad [3.124]$$

²⁵Some authors, following Dirac, take this to be an *axiom* of quantum mechanics, but it seems to me peculiar to use that term for something that is *provable* in many particular instances; I prefer to regard it as a part of what it *means* to be “observable”.

(or rather, they can always be *chosen* so); the completeness relation takes the form of an *integral*:

$$|\Psi\rangle = \int_{-\infty}^{\infty} c_k |e_k\rangle dk; \quad [3.125]$$

the “components” are given by “Fourier’s trick”:

$$c_k = \langle e_k | \Psi \rangle, \quad [3.126]$$

and the probability of getting an eigenvalue in the *range* dk about λ_k is

$$|c_k|^2 dk = |\langle e_k | \Psi \rangle|^2 dk. \quad [3.127]$$

The generalized statistical interpretation makes no reference to the observable x ; it treats *all* observables on an equal footing. But it includes the “original” form (Equation 1.3) as a special case. The “orthonormal” eigenfunctions of the position operator are

$$e_{x'}(x) = \delta(x - x'), \quad [3.128]$$

and the eigenvalue (x') can take on any value between $-\infty$ and $+\infty$. The x' “component” of $|\Psi\rangle$ is

$$c_{x'} = \langle e_{x'} | \Psi \rangle = \int_{-\infty}^{\infty} \delta(x - x') \Psi(x, t) dx = \Psi(x', t), \quad [3.129]$$

so the probability of finding the particle in the range dx' about x' is

$$|c_{x'}|^2 dx' = |\Psi(x', t)|^2 dx', \quad [3.130]$$

which is the original statistical interpretation of Ψ .

A more illuminating example is provided by the momentum operator. Its “orthonormal” eigenfunctions are (see Problem 3.37)

$$e_p(x) = \frac{1}{\sqrt{2\pi\hbar}} e^{ipx/\hbar}, \quad [3.131]$$

and the eigenvalue (p) can take on any value in the range $-\infty < p < \infty$. The p “component” of $|\Psi\rangle$ is

$$c_p = \langle e_p | \Psi \rangle = \frac{1}{\sqrt{2\pi\hbar}} \int_{-\infty}^{\infty} e^{-ipx/\hbar} \Psi(x, t) dx \equiv \Phi(p, t). \quad [3.132]$$

We call $\Phi(p, t)$ the **momentum-space wave function**—it is (apart from the factors of \hbar) the *Fourier transform* of the “position-space” wave function $\Psi(x, t)$. Evidently the probability of getting a momentum in the range dp is

$$|\Phi(p, t)|^2 dp. \quad [3.133]$$

***Problem 3.35**

- (a) Show that $\sum |c_n|^2 = 1$, in Equation 3.120.
 (b) Show that $\int |c_k|^2 dk = 1$, in Equation 3.125.
 (c) From postulate 3' it follows that

$$\langle Q \rangle = \sum \lambda_n |c_n|^2, \text{ or } \langle Q \rangle = \int \lambda_k |c_k|^2 dk, \quad [3.134]$$

for discrete and continuous spectra, respectively. Show that this is consistent with postulate 2: $\langle Q \rangle = \langle \Psi | \hat{Q} \Psi \rangle$.

***Problem 3.36**

- (a) Refer to Problem 2.6. If you measured the energy of this particle, what values might you get, and what is the probability of each? Use the answer to calculate the expectation value of H , and compare the answer you got before.
 (b) Do the same for Problem 2.8. *Hint:* To sum the series, look in a math table under "Sums of Reciprocal Powers" or "Riemann Zeta Function."

Problem 3.37 Confirm that $e_p(x)$ (in Equation 3.131) is the "orthonormal" eigenfunction of the momentum operator, with eigenvalue p .

Problem 3.38 Find the momentum-space wave function, $\Phi(p, t)$, for a particle in the ground state of the harmonic oscillator. What is the probability (to two significant digits) that a measurement of p on a particle in this state would yield a value outside the classical range (for the same energy)? *Hint:* Look in a math table under "Normal Distribution" or "Error Function" for the numerical part.

3.4 THE UNCERTAINTY PRINCIPLE

I stated the uncertainty principle (in the form $\sigma_x \sigma_p \geq \hbar/2$) back in Section 1.6, and you have checked it several times in the problems. But we have never actually *proved* it. In this section I shall prove a more general version of the uncertainty principle and explore some of its implications. The argument is beautiful, but rather abstract, so watch closely.

3.4.1 Proof of the Generalized Uncertainty Principle

For any observable A , we have (quoting Equation 3.116)

$$\sigma_A^2 = \langle (\hat{A} - \langle A \rangle) \Psi | (\hat{A} - \langle A \rangle) \Psi \rangle = \langle f | f \rangle,$$

where $|f\rangle \equiv (\hat{A} - \langle A \rangle)|\Psi\rangle$. Likewise, for any *other* observable B ,

$$\sigma_B^2 = \langle g|g\rangle, \quad \text{where } |g\rangle \equiv (\hat{B} - \langle B \rangle)|\Psi\rangle.$$

Therefore (invoking the Schwarz inequality, Equation 3.27),

$$\sigma_A^2 \sigma_B^2 = \langle f|f\rangle \langle g|g\rangle \geq |\langle f|g\rangle|^2. \quad [3.135]$$

Now, for any complex number z ,

$$|z|^2 = (\text{Re}(z))^2 + (\text{Im}(z))^2 \geq (\text{Im}(z))^2 = \left[\frac{1}{2i}(z - z^*)\right]^2. \quad [3.136]$$

Therefore, letting $z = \langle f|g\rangle$,

$$\sigma_A^2 \sigma_B^2 \geq \left(\frac{1}{2i}[\langle f|g\rangle - \langle g|f\rangle]\right)^2. \quad [3.137]$$

But

$$\begin{aligned} \langle f|g\rangle &= \langle (\hat{A} - \langle A \rangle)\Psi | (\hat{B} - \langle B \rangle)\Psi \rangle = \langle \Psi | (\hat{A} - \langle A \rangle)(\hat{B} - \langle B \rangle)\Psi \rangle \\ &= \langle \Psi | (\hat{A}\hat{B} - \hat{A}\langle B \rangle - \hat{B}\langle A \rangle + \langle A \rangle\langle B \rangle)\Psi \rangle \\ &= \langle \Psi | \hat{A}\hat{B}\Psi \rangle - \langle B \rangle \langle \Psi | \hat{A}\Psi \rangle - \langle A \rangle \langle \Psi | \hat{B}\Psi \rangle + \langle A \rangle \langle B \rangle \langle \Psi | \Psi \rangle \\ &= \langle \hat{A}\hat{B} \rangle - \langle B \rangle \langle A \rangle - \langle A \rangle \langle B \rangle + \langle A \rangle \langle B \rangle \\ &= \langle \hat{A}\hat{B} \rangle - \langle A \rangle \langle B \rangle. \end{aligned}$$

Similarly,

$$\langle g|f\rangle = \langle \hat{B}\hat{A} \rangle - \langle A \rangle \langle B \rangle,$$

so

$$\langle f|g\rangle - \langle g|f\rangle = \langle \hat{A}\hat{B} \rangle - \langle \hat{B}\hat{A} \rangle = \langle [\hat{A}, \hat{B}] \rangle,$$

where

$$[\hat{A}, \hat{B}] \equiv \hat{A}\hat{B} - \hat{B}\hat{A} \quad [3.138]$$

is the commutator of the two operators. *Conclusion:*

$$\sigma_A^2 \sigma_B^2 \geq \left(\frac{1}{2i} \langle [\hat{A}, \hat{B}] \rangle\right)^2. \quad [3.139]$$

This is the uncertainty principle in its most general form. (You might think the i makes it trivial—isn't the right side *negative*? No, for the commutator carries its own factor of i , and the two cancel out.)

For example, suppose the first observable is position ($\hat{A} = x$), and the second is momentum ($\hat{B} = (\hbar/i)d/dx$). To determine the commutator, we use an arbitrary

“test function”, $f(x)$:

$$[\hat{x}, \hat{p}]f(x) = x \frac{\hbar}{i} \frac{d}{dx}(f) - \frac{\hbar}{i} \frac{d}{dx}(xf) = \frac{\hbar}{i} \left[x \frac{df}{dx} - (f + x \frac{df}{dx}) \right] = i\hbar f,$$

so

$$[\hat{x}, \hat{p}] = i\hbar. \quad [3.140]$$

Accordingly,

$$\sigma_x^2 \sigma_p^2 \geq \left(\frac{1}{2i} i\hbar \right)^2 = \left(\frac{\hbar}{2} \right)^2,$$

or, since standard deviations are by their nature positive,

$$\sigma_x \sigma_p \geq \frac{\hbar}{2}. \quad [3.141]$$

That proves the original Heisenberg uncertainty principle, but we now see that it is just one application of a far more general theorem: There will be an “uncertainty principle” for *any pair of observables whose corresponding operators do not commute*. We call them **incompatible observables**. Evidently, incompatible observables do not have shared eigenvectors—at least, they cannot have a *complete set* of common eigenvectors. Matrices representing incompatible observables cannot be simultaneously diagonalized (that is, they cannot both be brought to diagonal form by the *same* similarity transformation). On the other hand, *compatible* observables (whose operators *do* commute) share a complete set of eigenvectors, and the corresponding matrices *can* be simultaneously diagonalized (see Problem 3.40).

***Problem 3.39** Prove the famous “(your name) uncertainty principle,” relating the uncertainty in position ($A = x$) to the uncertainty in energy ($B = p^2/2m + V$):

$$\sigma_x \sigma_H \geq \frac{\hbar}{2m} |\langle p \rangle|.$$

For stationary states this doesn’t tell you much—why not?

Problem 3.40 Prove the following:

- (a) If two matrices commute ($[A, B] = 0$), and you apply the same similarity transformation to both of them ($A' = SAS^{-1}$, $B' = SBS^{-1}$), the resulting matrices also commute ($[A', B'] = 0$).
- (b) Diagonal matrices always commute. (It follows from this that simultaneously diagonalizable matrices must commute. Conversely, if two Hermitian matrices commute, then they are simultaneously diagonalizable—i.e., they have a complete set of common eigenvectors. This is not so easy to prove²⁶ unless you happen to know that the spectrum of one of them is nondegenerate.)

²⁶See Byron and Fuller (footnote 14), Theorem 4.22.

- (c) If matrices \mathbf{A} and \mathbf{B} commute, and $|\alpha\rangle$ is an eigenvector of \mathbf{A} , and the spectrum of \mathbf{A} is nondegenerate, then $|\alpha\rangle$ is also an eigenvector of \mathbf{B} . (In that case the matrix \mathbf{S} that diagonalizes \mathbf{A} also diagonalizes \mathbf{B} .)

***Problem 3.41**

- (a) Prove the following commutator identity:

$$[\hat{A}\hat{B}, \hat{C}] = \hat{A}[\hat{B}, \hat{C}] + [\hat{A}, \hat{C}]\hat{B}. \quad [3.142]$$

- (b) Using Equations 3.140 and 3.142, show that

$$[\hat{x}^n, \hat{p}] = i\hbar n\hat{x}^{n-1}.$$

- (c) For any function $f(x)$ that can be expanded in a power series, show that

$$[f(\hat{x}), \hat{p}] = i\hbar f'(\hat{x}),$$

where the prime denotes differentiation.

3.4.2 The Minimum-Uncertainty Wave Packet

We have twice encountered wave functions that *hit* the position-momentum uncertainty limit ($\sigma_x\sigma_p = \hbar/2$): the ground state of the harmonic oscillator (Problem 2.14) and the Gaussian wave packet for the free particle (Problem 2.22). This raises an interesting question: What is the *most general* minimum-uncertainty wave packet? Looking back at the proof of the uncertainty principle, we note that there were two points at which *inequalities* came into the argument: Equation 3.135 and Equation 3.136. Suppose we require that each of these be an *equality*, and see what this tells us about Ψ . The Schwarz inequality becomes an equality when the angle between the two vectors (Equation 3.28) is zero—that is, when one is a multiple of the other: $|g\rangle = c|f\rangle$, for some scalar c . (Study the proof of the Schwarz inequality in Problem 3.5 if you're not convinced.) Meanwhile, in Equation 3.136 I threw away the real part of z ; equality results if $\text{Re}(z) = 0$, which is to say, if $\text{Re}\langle f|g\rangle = \text{Re}(c\langle f|f\rangle) = 0$. Now $\langle f|f\rangle$ is certainly real, so this means the constant c must be purely imaginary—let's call it ia . The necessary and sufficient condition for minimum uncertainty, then, is

$$|g\rangle = ia|f\rangle, \quad \text{where } a \text{ is real.} \quad [3.143]$$

In particular, for the position-momentum uncertainty principle this criterion becomes

$$\left(\frac{\hbar}{i} \frac{d}{dx} - \langle p \rangle\right) \Psi = ia(x - \langle x \rangle) \Psi, \quad [3.144]$$

which is a differential equation for Ψ as a function of x , with the general solution (see Problem 3.42)

$$\Psi(x) = Ae^{-a(x-\langle x \rangle)^2/2\hbar} e^{i\langle p \rangle x/\hbar}. \quad [3.145]$$

Evidently the minimum-uncertainty wave packet is a *Gaussian*—and sure enough, the two examples we encountered earlier *were* Gaussians.²⁷

Problem 3.42 Solve Equation 3.144 for $\Psi(x)$. (Note that $\langle x \rangle$ and $\langle p \rangle$ are *constants*, as far as x is concerned.)

3.4.3 The Energy-Time Uncertainty Principle

The position-momentum uncertainty principle is usually written in the form

$$\Delta x \Delta p \geq \frac{\hbar}{2}. \quad [3.146]$$

Δx (the “uncertainty” in x) is sloppy notation (and sloppy language) for the standard deviation in the results of repeated measurements on identically prepared systems. Equation 3.146 is often paired with the **energy-time uncertainty principle**,

$$\Delta t \Delta E \geq \frac{\hbar}{2}. \quad [3.147]$$

Indeed, in the context of special relativity the energy-time form might be thought of as a *consequence* of the position-momentum version, because x and t (or rather, ct) go together in the position-time four-vector, while p and E (or rather, E/c) go together in the energy-momentum four-vector. So in a relativistic theory Equation 3.147 would be a necessary concomitant to Equation 3.146. But we’re not doing relativistic quantum mechanics—the Schrödinger equation is explicitly nonrelativistic: It treats t and x on a very unequal footing (as a differential equation it is *first-order* in t , but *second-order* in x), and Equation 3.147 is emphatically *not* implied by Equation 3.146. My purpose now is to *derive* the energy-time uncertainty principle, and in the course of that derivation to persuade you that it is really an altogether different beast, whose similarity in appearance to the position-momentum uncertainty principle is quite misleading.

After all, position, momentum, and energy are all dynamical variables—measurable characteristics of the system, at any given time. But time itself is *not* a dynamical variable (not, at any rate, in a nonrelativistic theory): You don’t go out and measure the “time” of a particle, as you might its position or its energy. Time is the *independent* variable of which the dynamical quantities are *functions*. In particular, the Δt

²⁷Note that it is only the dependence of Ψ on x that is at issue here—the “constants” A , a , $\langle x \rangle$, and $\langle p \rangle$ may all be functions of time, and as time goes on Ψ may evolve away from the minimal form. All I’m asserting is that if, at some instant, the wave function is Gaussian in x , then (at that instant) the uncertainty product is minimal.

in the energy-time uncertainty principle is not the standard deviation of a collection of time measurements; roughly speaking (I'll make this more precise in a moment), it is the *time it takes the system to change substantially*.

As a measure of how fast the system is changing, let us compute the time derivative of the expectation value of some observable, $Q(x, p, t)$:

$$\frac{d}{dt}\langle Q \rangle = \frac{d}{dt}\langle \Psi | \hat{Q} \Psi \rangle = \langle \frac{\partial \Psi}{\partial t} | \hat{Q} \Psi \rangle + \langle \Psi | \frac{\partial \hat{Q}}{\partial t} \Psi \rangle + \langle \Psi | \hat{Q} \frac{\partial \Psi}{\partial t} \rangle.$$

Now the Schrödinger equation says

$$i\hbar \frac{\partial \Psi}{\partial t} = \hat{H} \Psi$$

(where $H = p^2/2m + V$ is the Hamiltonian). So

$$\frac{d}{dt}\langle Q \rangle = -\frac{1}{i\hbar}\langle \hat{H} \Psi | \hat{Q} \Psi \rangle + \frac{1}{i\hbar}\langle \Psi | \hat{Q} \hat{H} \Psi \rangle + \langle \frac{\partial \hat{Q}}{\partial t} \rangle.$$

But \hat{H} is Hermitian, so $\langle \hat{H} \Psi | \hat{Q} \Psi \rangle = \langle \Psi | \hat{H} \hat{Q} \Psi \rangle$, and hence

$$\boxed{\frac{d}{dt}\langle Q \rangle = \frac{i}{\hbar}\langle [\hat{H}, \hat{Q}] \rangle + \langle \frac{\partial \hat{Q}}{\partial t} \rangle.} \quad [3.148]$$

This is an interesting and useful result in its own right (see Problems 3.43 and 3.53). In the typical case, where the operator does not depend explicitly on t ,²⁸ it tells us that the rate of change of the expectation value is determined by the commutator of the operator with the Hamiltonian. In particular, if \hat{Q} commutes with \hat{H} , then $\langle Q \rangle$ is constant, and in this sense Q is a *conserved* quantity.

Suppose we pick $A = H$ and $B = Q$, in the generalized uncertainty principle (Equation 3.139), and assume that Q does not depend explicitly on t :

$$\sigma_H^2 \sigma_Q^2 \geq \left(\frac{1}{2i} \langle [\hat{H}, \hat{Q}] \rangle \right)^2 = \left(\frac{1}{2i} \hbar \frac{d\langle Q \rangle}{dt} \right)^2 = \left(\frac{\hbar}{2} \right)^2 \left(\frac{d\langle Q \rangle}{dt} \right)^2.$$

Or, more simply,

$$\sigma_H \sigma_Q \geq \frac{\hbar}{2} \left| \frac{d\langle Q \rangle}{dt} \right|. \quad [3.149]$$

Let's define $\Delta E \equiv \sigma_H$ (with Δ as the usual sloppy notation for standard deviation), and

$$\Delta t \equiv \frac{\sigma_Q}{|d\langle Q \rangle/dt|}. \quad [3.150]$$

²⁸As an example of *explicit* time dependence, think of the potential energy of a harmonic oscillator whose spring constant is changing (perhaps the temperature is rising, so the spring becomes more flexible): $Q = (1/2)m[\omega(t)]^2 x^2$.

Then

$$\Delta E \Delta t \geq \frac{\hbar}{2}, \quad [3.151]$$

and that's the energy-time uncertainty principle. But notice what is meant by Δt here: Since

$$\sigma_Q = \left| \frac{d\langle Q \rangle}{dt} \right| \Delta t,$$

Δt represents the *amount of time it takes the expectation value of Q to change by one standard deviation*. In particular, Δt depends entirely on what observable (Q) you care to look at—the change might be rapid for one observable and slow for another. But if ΔE is small, then the rate of change of *all* observables must be very gradual, and conversely, if *any* observable changes rapidly, the “uncertainty” in the energy must be large.

Example 1. In the extreme case of a stationary state, for which the energy is uniquely determined, all expectation values are constant in time ($\Delta t = \infty$)—as, in fact, we noticed some time ago (see Equation 2.8). To make something *happen*, you must take a linear combination of at least two stationary states—for example,

$$\Psi(x, t) = a\psi_1(x)e^{-iE_1t/\hbar} + b\psi_2(x)e^{-iE_2t/\hbar}.$$

If a , b , ψ_1 , and ψ_2 are real,

$$|\Psi(x, t)|^2 = a^2(\psi_1(x))^2 + b^2(\psi_2(x))^2 + 2ab\psi_1(x)\psi_2(x) \cos\left(\frac{E_2 - E_1}{\hbar}t\right).$$

The period of oscillation is $\tau = 2\pi\hbar/(E_2 - E_1)$. Roughly, then, $\Delta E = E_2 - E_1$ and $\Delta t = \tau$ (for the *exact* calculation, see Problem 3.44), so

$$\Delta E \Delta t = 2\pi\hbar > \frac{\hbar}{2}.$$

Example 2. How long does it take a free particle wave packet to pass by a particular point (Figure 3.1)? Qualitatively (an exact version is explored in Problem 3.45), $\Delta t = \Delta x/v = m\Delta x/p$, but $E = p^2/2m$, so $\Delta E = p\Delta p/m$. Therefore,

$$\Delta E \Delta t = \frac{p\Delta p}{m} \frac{m\Delta x}{p} = \Delta x \Delta p \geq \frac{\hbar}{2}.$$

Example 3. The Δ particle lasts about 10^{-23} seconds before spontaneously disintegrating. If you make a histogram of all measurements of its mass, you get a kind of bell-shaped curve centered at $1232 \text{ MeV}/c^2$, with a width of about 115

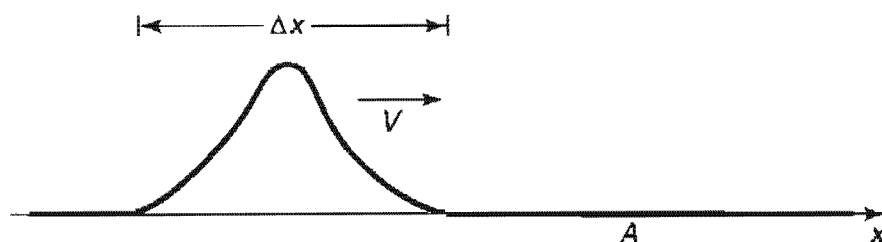

Figure 3.1: A free particle wave packet approaches the point A (Example 2).

MeV/c^2 . Why does the rest energy (mc^2) sometimes come out higher than 1232, and sometimes lower? Is this experimental error? No, for

$$\Delta E \Delta t = \left(\frac{115}{2} \text{ MeV}\right)(10^{-23} \text{ sec}) = 6 \times 10^{-22} \text{ MeV sec},$$

whereas $\hbar/2 = 3 \times 10^{-22} \text{ MeV sec}$. So the spread in m is about as small as the uncertainty principle allows—a particle with so short a lifetime just doesn't *have* a very well-defined mass.²⁹

Notice the variety of specific meanings attaching to the term Δt in these examples: In Example 1 it's a period of oscillation; in Example 2 it's the time it takes a particle to pass a point; in Example 3 it's the lifetime of an unstable particle. In every case, however, Δt is the time it takes for the system to undergo substantial change. It is often said that the uncertainty principle means that energy is not strictly conserved in quantum mechanics—that you're allowed to "borrow" energy ΔE , as long as you "pay it back" in a time $\Delta t \approx \hbar/2\Delta E$; the greater the violation, the briefer the period over which it can occur. There are many legitimate readings of the energy-time uncertainty principle, but this is not one of them. Nowhere does quantum mechanics license violation of energy conservation, and certainly no such authorization entered into the derivation of Equation 3.151. But the uncertainty principle is extraordinarily robust: It can be misused without leading to seriously incorrect results, and as a consequence physicists are in the habit of applying it rather carelessly.

***Problem 3.43** Apply Equation 3.148 to the following special cases: (a) $Q = 1$; (b) $Q = H$; (c) $Q = x$; (d) $Q = p$. In each case, comment on the result, with particular reference to Equations 1.27, 1.33, 1.38, and 2.35.

****Problem 3.44** Test the energy-time uncertainty principle for the wave function in Problem 2.6 and the observable x by calculating σ_H , σ_x , and $d\langle x \rangle/dt$ exactly.

²⁹Actually, Example 3 is a bit of a fraud. You can't measure 10^{-23} sec on a stop-watch, and in practice the lifetime of such a short-lived particle is *inferred* from the width of the mass plot, using the uncertainty principle as *input*. However, the point is valid even if the numbers are suspect. Moreover, if you assume the Δ is about the same size as a proton ($\sim 10^{-15} \text{ m}$), then 10^{-23} sec is roughly the time it takes light to cross the particle, and it's hard to imagine that the lifetime could be much *less* than that.

****Problem 3.45** Test the energy-time uncertainty principle for the free particle wave packet in Problem 2.40 and the observable x by calculating σ_H , σ_x , and $d\langle x \rangle/dt$ exactly.

Problem 3.46 Show that the energy-time uncertainty principle reduces to the “your name” uncertainty principle (Problem 3.39) when the observable in question is x .

FURTHER PROBLEMS FOR CHAPTER 3

****Problem 3.47** Functions of matrices are defined by their Taylor series expansions; for example,

$$e^{\mathbf{M}} \equiv \mathbf{1} + \mathbf{M} + \frac{1}{2}\mathbf{M}^2 + \frac{1}{3!}\mathbf{M}^3 + \dots \quad [3.152]$$

(a) Find $\exp(\mathbf{M})$, if

$$(i) \mathbf{M} = \begin{pmatrix} 0 & 1 & 3 \\ 0 & 0 & 4 \\ 0 & 0 & 0 \end{pmatrix}; \quad (ii) \mathbf{M} = \begin{pmatrix} 0 & \theta \\ -\theta & 0 \end{pmatrix}.$$

(b) Show that if \mathbf{M} is diagonalizable, then

$$\det(e^{\mathbf{M}}) = e^{\text{Tr}(\mathbf{M})}. \quad [3.153]$$

(This is actually *true* even if \mathbf{M} is *not* diagonalizable, but it’s harder to prove in the general case.)

(c) Show that if the matrices \mathbf{M} and \mathbf{N} commute, then

$$e^{\mathbf{M}+\mathbf{N}} = e^{\mathbf{M}}e^{\mathbf{N}}. \quad [3.154]$$

Prove (with the simplest counterexample you can think up) that Equation 3.154 is *not* true, in general, for noncommuting matrices.

(d) If \mathbf{H} is Hermitian, show that $e^{i\mathbf{H}}$ is unitary.

***Problem 3.48** A particle of mass m is in the ground state of the infinite square well (Equation 2.15). Suddenly the well expands to twice its original size—the right wall moving from a to $2a$ —leaving the wave function (momentarily) undisturbed. The energy of the particle is now measured.

(a) What is the most probable result? What is the probability of getting that result?

(b) What is the *next* most probable result, and what is its probability?

(c) What is the *expectation value* of the energy? (If you find yourself confronted with an infinite series, try another method.)

Problem 3.49 A harmonic oscillator is in a state such that a measurement of the energy would yield either $(1/2)\hbar\omega$ or $(3/2)\hbar\omega$, with equal probability. What is the largest possible value of $\langle x \rangle$ in such a state? If it assumes this maximal value at time $t = 0$, what is $\Psi(x, t)$?

****Problem 3.50** Find the matrix elements $\langle n|x|n' \rangle$ and $\langle n|p|n' \rangle$ in the (orthonormal) basis consisting of stationary states for the harmonic oscillator (here $|n\rangle$ refers to the state ψ_n , Eq. 2.50). [You already calculated the diagonal elements ($n = n'$) in Problem 2.37; use the same technique for the general case.] Construct the corresponding (infinite) matrices, \mathbf{X} and \mathbf{P} . Show that $(1/2m)\mathbf{P}^2 + (m\omega^2/2)\mathbf{X}^2 = \mathbf{H}$ is *diagonal*, in this basis. Are its diagonal elements what you would expect? *Partial answer:*

$$\langle n|x|n' \rangle = \sqrt{\frac{\hbar}{2m\omega}} \left(\sqrt{n'}\delta_{n,n'-1} + \sqrt{n}\delta_{n',n-1} \right). \quad [3.155]$$

*****Problem 3.51** Show that

$$\langle x \rangle = \int \Phi^* \left(-\frac{\hbar}{i} \frac{\partial}{\partial p} \right) \Phi dp, \quad [3.156]$$

where $\Phi(p, t)$ is the momentum-space wave function. In general,

$$\langle Q(x, p, t) \rangle = \begin{cases} \int \Psi^* \hat{Q} \left(x, \frac{\hbar}{i} \frac{\partial}{\partial x}, t \right) \Psi dx, & \text{in position space;} \\ \int \Phi^* \hat{Q} \left(-\frac{\hbar}{i} \frac{\partial}{\partial p}, p, t \right) \Phi dp, & \text{in momentum space.} \end{cases} \quad [3.157]$$

Hint: Notice that $x \exp(ipx/\hbar) = -i\hbar(d/dp) \exp(ipx/\hbar)$.

****Problem 3.52** Find the momentum-space wave function $\Phi_n(p, t)$ for the n th stationary state of the infinite square well. Construct $|\Phi_n|^2$ (it's simplest to write separate formulas for odd and even n). Show that $|\Phi_n|^2$ is finite at $p = \pm n\pi\hbar/a$.

***Problem 3.53** Use Equation 3.148 to show that

$$\frac{d}{dt} \langle xp \rangle = 2\langle T \rangle - \left\langle x \frac{dV}{dx} \right\rangle, \quad [3.158]$$

where T is the kinetic energy ($H = T + V$). In a *stationary* state the left side is zero (why?), so

$$2\langle T \rangle = \left\langle x \frac{dV}{dx} \right\rangle. \quad [3.159]$$

This is called the **virial theorem**. Use it to prove that $\langle T \rangle = \langle V \rangle$ for stationary states of the harmonic oscillator, and check that this is consistent with the results you got in Problems 2.14 and 2.37.

Problem 3.54 What would it mean for an observable Q to be *conserved*, in quantum mechanics? At a minimum, the expectation value of Q should be constant in time, for any state Ψ . The criterion for this (assuming Q has no *explicit* time dependence) is that \hat{Q} commute with the Hamiltonian (Equation 3.148). But we'd like something more: The probability $|c_n|^2$ of getting any particular eigenvalue (λ_n) of \hat{Q} should be independent of t . Show that this, too, is guaranteed by the condition $[\hat{H}, \hat{Q}] = 0$. (Assume that the potential energy is independent of t , but do *not* assume Ψ is a stationary state.) *Hint:* \hat{Q} and \hat{H} are compatible observables, so they have a complete set of simultaneous eigenvalues.

****Problem 3.55**

(a) For a function $f(x)$ that can be expanded in a Taylor series, show that

$$f(x + x_0) = e^{i\hat{p}x_0/\hbar} f(x)$$

(where x_0 is any constant distance). For this reason, \hat{p}/\hbar is called the **generator of translations in space**. (See Problem 3.47 for the meaning of an operator in the exponent.)

(b) If $\Psi(x, t)$ satisfies the (time-dependent) Schrödinger equation, show that

$$\Psi(x, t + t_0) = e^{-i\hat{H}t_0/\hbar} \Psi(x, t)$$

(where t_0 is any constant time); $-\hat{H}/\hbar$ is called the **generator of translations in time**.

(c) Show that the expectation value of a dynamical variable $Q(x, p, t)$, at time $t + t_0$, can be written

$$\langle Q \rangle_{t+t_0} = \langle \Psi(x, t) | e^{i\hat{H}t_0/\hbar} \hat{Q}(\hat{x}, \hat{p}, t + t_0) e^{-i\hat{H}t_0/\hbar} | \Psi(x, t) \rangle.$$

Use this to recover Equation 3.148. *Hint:* Let $t_0 = dt$, and expand to first order in dt .

Problem 3.56 In an interesting version of the energy-time uncertainty principle³⁰ $\Delta t = \tau/\pi$, where τ is the time it takes $\Psi(x, t)$ to evolve into a state orthogonal to $\Psi(x, 0)$. Test this out, using a wave function that is an equal admixture of two (orthonormal) stationary states of some (arbitrary) potential: $\Psi(x, 0) = (1/\sqrt{2})[\psi_1(x) + \psi_2(x)]$.

****Problem 3.57** Dirac proposed to peel apart the bracket notation for an inner product, $\langle \alpha | \beta \rangle$, into two pieces, which he called **bra** ($\langle \alpha |$) and **ket** ($| \beta \rangle$). The latter is a vector, but what exactly is the former? It's a *linear function* of vectors, in the sense that when it hits a vector (to its right) it yields a (complex) number—the inner

³⁰See Lev Vaidman, *Am. J. Phys.* **60**, 182 (1992) for a proof.

product.³¹ (When an *operator* hits a vector, it delivers another vector; when a *bra* hits a vector, it delivers a number.) Actually, the collection of all bras constitutes another vector space—the so-called **dual space**.

The license to treat bras as separate entities in their own right allows for some powerful and pretty notation (though I shall not exploit it further in this book). For example, if $|\alpha\rangle$ is a normalized vector, the operator

$$\hat{P} \equiv |\alpha\rangle\langle\alpha| \tag{3.160}$$

picks out the component of any other vector that “lies along” $|\alpha\rangle$:

$$\hat{P}|\beta\rangle = \langle\alpha|\beta\rangle|\alpha\rangle;$$

we call it the **projection operator** onto the one-dimensional subspace spanned by $|\alpha\rangle$.

- (a) Show that $\hat{P}^2 = \hat{P}$. Determine the eigenvalues of \hat{P} , and characterize its eigenvectors.
- (b) Suppose $|e_j\rangle$ is an orthonormal basis for an n -dimensional vector space. Show that

$$\sum_{j=1}^n |e_j\rangle\langle e_j| = 1. \tag{3.161}$$

This is the tidiest statement of completeness.

- (c) Let \hat{Q} be an operator with a complete set of orthonormal eigenvectors:

$$\hat{Q}|e_j\rangle = \lambda_j|e_j\rangle \quad (j = 1, 2, 3, \dots, n).$$

Show that \hat{Q} can be written in terms of its **spectral decomposition**:

$$\hat{Q} = \sum_{j=1}^n \lambda_j |e_j\rangle\langle e_j|. \tag{3.162}$$

Hint: An operator is characterized by its action on all possible vectors, so what you must show is that

$$\hat{Q}|\alpha\rangle = \left\{ \sum_{j=1}^n \lambda_j |e_j\rangle\langle e_j| \right\} |\alpha\rangle,$$

for any vector $|\alpha\rangle$.

³¹In a function space, the bra can be thought of as an instruction to integrate

$$\langle f| = \int f^*[\dots] dx,$$

with the “hole” $[\dots]$ waiting to be filled by whatever function the bra encounters next.

***Problem 3.58** Imagine a system in which there are just *two* linearly independent states:

$$|1\rangle = \begin{pmatrix} 1 \\ 0 \end{pmatrix} \quad \text{and} \quad |2\rangle = \begin{pmatrix} 0 \\ 1 \end{pmatrix}.$$

The most general state is a normalized linear combination:

$$|\Psi\rangle = a|1\rangle + b|2\rangle = \begin{pmatrix} a \\ b \end{pmatrix}, \quad \text{with } |a|^2 + |b|^2 = 1.$$

Suppose the Hamiltonian matrix is

$$\mathbf{H} = \begin{pmatrix} h & g \\ g & h \end{pmatrix},$$

where g and h are real constants. The (time-dependent) Schrödinger equation says

$$\mathbf{H}|\Psi\rangle = i\hbar \frac{d}{dt}|\Psi\rangle.$$

- (a) Find the eigenvalues and (normalized) eigenvectors of this Hamiltonian.
 (b) Suppose the system starts out (at $t = 0$) in state $|1\rangle$. What is the state at time t ?

Answer:

$$|\Psi(t)\rangle = e^{-iht/\hbar} \begin{pmatrix} \cos(gt/\hbar) \\ -i \sin(gt/\hbar) \end{pmatrix}.$$

Note: This is about the simplest nontrivial quantum system conceivable. It is a crude model for (among other things) **neutrino oscillations**. In that case $|1\rangle$ represents the electron neutrino, and $|2\rangle$ the muon neutrino; if the Hamiltonian has a nonvanishing off-diagonal term g , then in the course of time the electron neutrino will turn into a muon neutrino, and back again. At present this is highly speculative—there is no experimental evidence for neutrino oscillations; however, a very similar phenomenon does occur in the case of neutral K -mesons (K^0 and \bar{K}^0).

CHAPTER 4

QUANTUM MECHANICS IN THREE DIMENSIONS

4.1 SCHRÖDINGER EQUATION IN SPHERICAL COORDINATES

The generalization to three dimensions is straightforward. Schrödinger's equation says

$$i\hbar \frac{\partial \Psi}{\partial t} = H\Psi; \quad [4.1]$$

the Hamiltonian operator¹ H is obtained from the classical energy

$$\frac{1}{2}mv^2 + V = \frac{1}{2m}(p_x^2 + p_y^2 + p_z^2) + V$$

by the standard prescription (applied now to y and z , as well as x):

$$p_x \rightarrow \frac{\hbar}{i} \frac{\partial}{\partial x}, \quad p_y \rightarrow \frac{\hbar}{i} \frac{\partial}{\partial y}, \quad p_z \rightarrow \frac{\hbar}{i} \frac{\partial}{\partial z}, \quad [4.2]$$

or

$$\boxed{\mathbf{p} \rightarrow \frac{\hbar}{i} \nabla,} \quad [4.3]$$

¹Where confusion might otherwise occur, I have been putting “hats” on operators to distinguish them from the corresponding classical observables. I don't think there will be much occasion for ambiguity in this chapter, and the hats get to be cumbersome, so I am going to leave them off from now on.

for short. Thus

$$i\hbar \frac{\partial \Psi}{\partial t} = -\frac{\hbar^2}{2m} \nabla^2 \Psi + V\Psi, \quad [4.4]$$

where

$$\nabla^2 \equiv \frac{\partial^2}{\partial x^2} + \frac{\partial^2}{\partial y^2} + \frac{\partial^2}{\partial z^2} \quad [4.5]$$

is the **Laplacian**, in Cartesian coordinates.

The potential energy V and the wave function Ψ are now functions of $\mathbf{r} = (x, y, z)$ and t . The probability of finding the particle in the infinitesimal volume $d^3\mathbf{r} = dx dy dz$ is $|\Psi(\mathbf{r}, t)|^2 d^3\mathbf{r}$, and the normalization condition reads

$$\int |\Psi|^2 d^3\mathbf{r} = 1, \quad [4.6]$$

with the integral taken over all space. If the potential is independent of time, there will be a complete set of stationary states,

$$\Psi_n(\mathbf{r}, t) = \psi_n(\mathbf{r})e^{-iE_n t/\hbar}, \quad [4.7]$$

where the spatial wave function ψ_n satisfies the *time-independent* Schrödinger equation:

$$-\frac{\hbar^2}{2m} \nabla^2 \psi_n + V\psi_n = E_n \psi_n. \quad [4.8]$$

The general solution to the (*time-dependent*) Schrödinger equation is

$$\Psi(\mathbf{r}, t) = \sum c_n \psi_n(\mathbf{r})e^{-iE_n t/\hbar}, \quad [4.9]$$

with the constants c_n determined by the initial wave function, $\Psi(\mathbf{r}, 0)$, in the usual way. (If the potential admits continuum states, then the sum in Equation 4.9 becomes an integral.)

*Problem 4.1

- (a) Work out all of the **canonical commutation relations** for components of the operators \mathbf{r} and \mathbf{p} : $[x, y]$, $[x, p_y]$, $[x, p_x]$, $[p_y, p_z]$, and so on. *Answer:*

$$[r_i, p_j] = -[p_i, r_j] = i\hbar\delta_{ij}, \quad [r_i, r_j] = [p_i, p_j] = 0. \quad [4.10]$$

- (b) Show that

$$\frac{d}{dt}\langle \mathbf{r} \rangle = \frac{1}{m}\langle \mathbf{p} \rangle, \quad \text{and} \quad \frac{d}{dt}\langle \mathbf{p} \rangle = \langle -\nabla V \rangle. \quad [4.11]$$

(Each of these, of course, stands for *three* equations—one for each component.)

Hint: Note that Equation 3.148 is valid in three dimensions.

(c) Formulate Heisenberg's uncertainty principle in three dimensions. *Answer:*

$$\sigma_x \sigma_{p_x} \geq \hbar/2, \quad \sigma_y \sigma_{p_y} \geq \hbar/2, \quad \sigma_z \sigma_{p_z} \geq \hbar/2, \quad [4.12]$$

but there is no restriction on, say, $\sigma_x \sigma_{p_y}$.

4.1.1 Separation of Variables

Typically, the potential is a function only of the distance from the origin. In that case it is natural to adopt **spherical coordinates**, (r, θ, ϕ) (see Figure 4.1). In spherical coordinates the Laplacian takes the form²

$$\nabla^2 = \frac{1}{r^2} \frac{\partial}{\partial r} \left(r^2 \frac{\partial}{\partial r} \right) + \frac{1}{r^2 \sin \theta} \frac{\partial}{\partial \theta} \left(\sin \theta \frac{\partial}{\partial \theta} \right) + \frac{1}{r^2 \sin^2 \theta} \left(\frac{\partial^2}{\partial \phi^2} \right). \quad [4.13]$$

In spherical coordinates, then, the time-independent Schrödinger equation reads

$$-\frac{\hbar^2}{2m} \left[\frac{1}{r^2} \frac{\partial}{\partial r} \left(r^2 \frac{\partial \psi}{\partial r} \right) + \frac{1}{r^2 \sin \theta} \frac{\partial}{\partial \theta} \left(\sin \theta \frac{\partial \psi}{\partial \theta} \right) + \frac{1}{r^2 \sin^2 \theta} \left(\frac{\partial^2 \psi}{\partial \phi^2} \right) \right] + V \psi = E \psi. \quad [4.14]$$

We begin by looking for solutions that are separable into products:

$$\psi(r, \theta, \phi) = R(r)Y(\theta, \phi). \quad [4.15]$$

Putting this into Equation 4.14, we have

$$-\frac{\hbar^2}{2m} \left[\frac{Y}{r^2} \frac{d}{dr} \left(r^2 \frac{dR}{dr} \right) + \frac{R}{r^2 \sin \theta} \frac{\partial}{\partial \theta} \left(\sin \theta \frac{\partial Y}{\partial \theta} \right) + \frac{R}{r^2 \sin^2 \theta} \frac{\partial^2 Y}{\partial \phi^2} \right] + V R Y = E R Y.$$

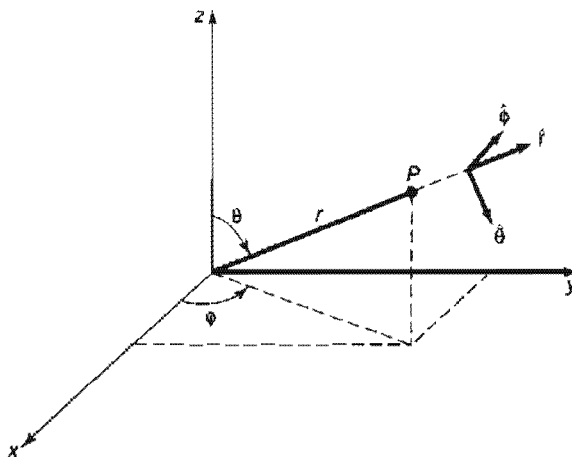

Figure 4.1: Spherical coordinates: radius r , polar angle θ , and azimuthal angle ϕ .

²In principle, this can be obtained by change of variables from the Cartesian expression (Equation 4.5). However, there are much more efficient ways of getting it; see, for instance, M. Boas, *Mathematical Methods in the Physical Sciences*, 2nd ed. (New York: John Wiley and Sons, Inc., 1983) Chapter 10, Section 9.

Dividing by YR and multiplying by $-2mr^2/\hbar^2$:

$$\left\{ \frac{1}{R} \frac{d}{dr} \left(r^2 \frac{dR}{dr} \right) - \frac{2mr^2}{\hbar^2} [V(r) - E] \right\} + \frac{1}{Y} \left\{ \frac{1}{\sin \theta} \frac{\partial}{\partial \theta} \left(\sin \theta \frac{\partial Y}{\partial \theta} \right) + \frac{1}{\sin^2 \theta} \frac{\partial^2 Y}{\partial \phi^2} \right\} = 0.$$

The term in the first curly bracket depends only on r , whereas the remainder depends only on θ and ϕ ; accordingly, each must be a constant. For reasons that will appear in due course, I will write this “separation constant” in the form $l(l+1)$.³

$$\frac{1}{R} \frac{d}{dr} \left(r^2 \frac{dR}{dr} \right) - \frac{2mr^2}{\hbar^2} [V(r) - E] = l(l+1); \quad [4.16]$$

$$\frac{1}{Y} \left\{ \frac{1}{\sin \theta} \frac{\partial}{\partial \theta} \left(\sin \theta \frac{\partial Y}{\partial \theta} \right) + \frac{1}{\sin^2 \theta} \frac{\partial^2 Y}{\partial \phi^2} \right\} = -l(l+1). \quad [4.17]$$

***Problem 4.2** Use separation of variables in Cartesian coordinates to solve the infinite cubical well (or “particle in a box”):

$$V(x, y, z) = \begin{cases} 0, & \text{if } x, y, z \text{ are all between } 0 \text{ and } a; \\ \infty, & \text{otherwise.} \end{cases}$$

- (a) Find the stationary state wave functions and the corresponding energies.
 - (b) Call the distinct energies E_1, E_2, E_3, \dots , in order of increasing energy. Find E_1, E_2, E_3, E_4, E_5 , and E_6 . Determine the degeneracy of each of these energies (that is, the number of different states that share the same energy). Recall (Problem 2.42) that degenerate bound states do not occur in *one* dimension, but they are common in three dimensions.
 - (c) What is the degeneracy of E_{14} , and why is this case interesting?
-

4.1.2 The Angular Equation

Equation 4.17 determines the dependence of ψ on θ and ϕ ; multiplying by $Y \sin^2 \theta$, it becomes

$$\sin \theta \frac{\partial}{\partial \theta} \left(\sin \theta \frac{\partial Y}{\partial \theta} \right) + \frac{\partial^2 Y}{\partial \phi^2} = -l(l+1) \sin^2 \theta Y. \quad [4.18]$$

³Note that there is no loss of generality here—at this stage l could be any complex number. Later on we’ll discover that l must in fact be an *integer*, and it is in anticipation of that result that I express the separation constant in a way that looks peculiar now.

You may have encountered this equation already—it occurs in the solution to Laplace’s equation in classical electrodynamics. As always, we try separation of variables:

$$Y(\theta, \phi) = \Theta(\theta)\Phi(\phi). \quad [4.19]$$

Plugging this in, and dividing by $\Theta\Phi$, we find

$$\left\{ \frac{1}{\Theta} \left[\sin\theta \frac{d}{d\theta} \left(\sin\theta \frac{d\Theta}{d\theta} \right) \right] + l(l+1) \sin^2\theta \right\} + \frac{1}{\Phi} \frac{d^2\Phi}{d\phi^2} = 0.$$

The first term is a function only of θ , and the second is a function only of ϕ , so each must be a constant. This time I’ll call the separation constant m^2 :⁴

$$\frac{1}{\Theta} \left[\sin\theta \frac{d}{d\theta} \left(\sin\theta \frac{d\Theta}{d\theta} \right) \right] + l(l+1) \sin^2\theta = m^2; \quad [4.20]$$

$$\frac{1}{\Phi} \frac{d^2\Phi}{d\phi^2} = -m^2. \quad [4.21]$$

The ϕ equation is easy:

$$\frac{d^2\Phi}{d\phi^2} = -m^2\Phi \Rightarrow \Phi(\phi) = e^{im\phi}. \quad [4.22]$$

[Actually, there are *two* solutions: $\exp(im\phi)$ and $\exp(-im\phi)$, but we’ll cover the latter by allowing m to run negative. There could also be a constant factor in front, but we might as well absorb that into Θ . Incidentally, in electrodynamics we would write the azimuthal function (Φ) in terms of sines and cosines, instead of exponentials, because electric potentials must be *real*. In quantum mechanics there is no such constraint, and the exponentials are a lot easier to work with.] Now, when ϕ advances by 2π , we return to the same point in space (see Figure 4.1), so it is natural to require that⁵

$$\Phi(\phi + 2\pi) = \Phi(\phi). \quad [4.23]$$

In other words, $\exp[im(\phi + 2\pi)] = \exp(im\phi)$, or $\exp(2\pi im) = 1$. From this it follows that m must be an *integer*:

$$m = 0, \pm 1, \pm 2, \dots \quad [4.24]$$

⁴Again, there is no loss of generality here since at this stage m could be any complex number; in a moment, though, we will discover that m must in fact be an *integer*. *Beware*: The letter m is now doing double duty, as *mass* and as the so-called **magnetic quantum number**. There is no graceful way to avoid this since both uses are standard. Some authors now switch to M or μ for mass, but I hate to change notation in midstream, and I don’t think confusion will arise as long as you are aware of the problem.

⁵This is a more subtle point than it looks. After all, the *probability density* ($|\Phi|^2$) is single valued *regardless* of m . In Section 4.3 we’ll obtain the condition on m by an entirely different—and more compelling—argument.

The θ equation,

$$\sin \theta \frac{d}{d\theta} \left(\sin \theta \frac{d\Theta}{d\theta} \right) + [l(l+1) \sin^2 \theta - m^2] \Theta = 0, \quad [4.25]$$

may not be so familiar. The solution is

$$\Theta(\theta) = A P_l^m(\cos \theta), \quad [4.26]$$

where P_l^m is the **associated Legendre function**, defined by⁶

$$P_l^m(x) \equiv (1-x^2)^{|m|/2} \left(\frac{d}{dx} \right)^{|m|} P_l(x), \quad [4.27]$$

and $P_l(x)$ is the l th Legendre polynomial. We encountered the latter (Equation 3.91) as orthogonal polynomials on the interval $(-1, +1)$; for our present purposes it is more convenient to define them by the **Rodrigues formula**:

$$P_l(x) \equiv \frac{1}{2^l l!} \left(\frac{d}{dx} \right)^l (x^2 - 1)^l. \quad [4.28]$$

For example,

$$P_0(x) = 1, \quad P_1(x) = \frac{1}{2} \frac{d}{dx} (x^2 - 1) = x,$$

$$P_2(x) = \frac{1}{4 \cdot 2} \left(\frac{d}{dx} \right)^2 (x^2 - 1)^2 = \frac{1}{2} (3x^2 - 1),$$

and so on. The first few Legendre polynomials were listed in Table 3.1. As the name suggests, $P_l(x)$ is a polynomial (of degree l) in x , and is even or odd according to the parity of l . But $P_l^m(x)$ is not, in general, a polynomial—if m is odd it carries a factor of $\sqrt{1-x^2}$:

$$P_2^0(x) = \frac{1}{2} (3x^2 - 1), \quad P_2^1(x) = (1-x^2)^{1/2} \frac{d}{dx} \left[\frac{1}{2} (3x^2 - 1) \right] = 3x \sqrt{1-x^2},$$

$$P_2^2(x) = (1-x^2) \left(\frac{d}{dx} \right) \left[\frac{1}{2} (3x^2 - 1) \right] = 3(1-x^2),$$

etc. [On the other hand, what we need is $P_l^m(\cos \theta)$, and $\sqrt{1-\cos^2 \theta} = \sin \theta$, so $P_l^m(\cos \theta)$ is always a polynomial in $\cos \theta$, multiplied—if m is odd—by $\sin \theta$. Some associated Legendre functions of $\cos \theta$ are listed in Table 4.1.]

⁶Notice that $P_l^{-m} = P_l^m$. Some authors adopt a different sign convention for negative values of m ; see Boas (footnote 2) p. 505.

Table 4.1: Some associated Legendre functions, $P_l^m(\cos\theta)$.

| | |
|---|--|
| $P_1^1 = \sin\theta$ | $P_3^3 = 15 \sin\theta(1 - \cos^2\theta)$ |
| $P_1^0 = \cos\theta$ | $P_3^2 = 15 \sin^2\theta \cos\theta$ |
| $P_2^2 = 3 \sin^2\theta$ | $P_3^1 = \frac{3}{2} \sin\theta(5 \cos^2\theta - 1)$ |
| $P_2^1 = 3 \sin\theta \cos\theta$ | $P_3^0 = \frac{1}{2}(5 \cos^3\theta - 3 \cos\theta)$ |
| $P_2^0 = \frac{1}{2}(3 \cos^2\theta - 1)$ | |

Notice that l must be a nonnegative integer for the Rodrigues formula to make any sense; moreover, if $|m| > l$, then Equation 4.27 says $P_l^m = 0$. For any given l , then, there are $(2l + 1)$ possible values of m :

$$l = 0, 1, 2, \dots; \quad m = -l, -l + 1, \dots, -1, 0, 1, \dots, l - 1, l. \quad [4.29]$$

But wait! Equation 4.25 is a second-order differential equation: It should have *two* linearly independent solutions, for *any old* values of l and m . Where are all the *other* solutions? *Answer:* They *exist*, of course, as mathematical solutions to the equation, but they are *physically* unacceptable because they blow up at $\theta = 0$ and/or $\theta = \pi$, and do not yield normalizable wave functions (see Problem 4.4).

Now, the volume element in spherical coordinates⁷ is

$$d^3\mathbf{r} = r^2 \sin\theta \, dr \, d\theta \, d\phi, \quad [4.30]$$

so the normalization condition (Equation 4.6) becomes

$$\int |\psi|^2 r^2 \sin\theta \, dr \, d\theta \, d\phi = \int |R|^2 r^2 \, dr \int |Y|^2 \sin\theta \, d\theta \, d\phi = 1.$$

It is convenient to normalize R and Y individually:

$$\int_0^\infty |R|^2 r^2 \, dr = 1 \quad \text{and} \quad \int_0^{2\pi} \int_0^\pi |Y|^2 \sin\theta \, d\theta \, d\phi = 1. \quad [4.31]$$

The normalized angular wave functions⁸ are called **spherical harmonics**:

⁷See, for instance, Boas, (footnote 2), Chapter 5, Section 4.

⁸The normalization factor is derived in Problem 4.47. The ϵ factor is chosen for consistency with the notation we will be using in the theory of angular momentum; it is reasonably standard, though some older books use other conventions. Notice that

$$Y_l^{-m} = (-1)^m Y_l^m.$$

Table 4.2: The first few spherical harmonics, $Y_l^m(\theta, \phi)$.

| | |
|--|---|
| $Y_0^0 = \left(\frac{1}{4\pi}\right)^{1/2}$ | $Y_2^{\pm 2} = \left(\frac{15}{32\pi}\right)^{1/2} \sin^2 \theta e^{\pm 2i\phi}$ |
| $Y_1^0 = \left(\frac{3}{4\pi}\right)^{1/2} \cos \theta$ | $Y_3^0 = \left(\frac{7}{16\pi}\right)^{1/2} (5 \cos^3 \theta - 3 \cos \theta)$ |
| $Y_1^{\pm 1} = \mp \left(\frac{3}{8\pi}\right)^{1/2} \sin \theta e^{\pm i\phi}$ | $Y_3^{\pm 1} = \mp \left(\frac{21}{64\pi}\right)^{1/2} \sin \theta (5 \cos^2 \theta - 1) e^{\pm i\phi}$ |
| $Y_2^0 = \left(\frac{5}{16\pi}\right)^{1/2} (3 \cos^2 \theta - 1)$ | $Y_3^{\pm 2} = \left(\frac{105}{32\pi}\right)^{1/2} \sin^2 \theta \cos \theta e^{\pm 2i\phi}$ |
| $Y_2^{\pm 1} = \mp \left(\frac{15}{8\pi}\right)^{1/2} \sin \theta \cos \theta e^{\pm i\phi}$ | $Y_3^{\pm 3} = \mp \left(\frac{35}{64\pi}\right)^{1/2} \sin^3 \theta e^{\pm 3i\phi}$ |

$$Y_l^m(\theta, \phi) = \epsilon \sqrt{\frac{(2l+1)(l-|m|)!}{4\pi(l+|m|)!}} e^{im\phi} P_l^m(\cos \theta), \quad [4.32]$$

where $\epsilon = (-1)^m$ for $m \geq 0$ and $\epsilon = 1$ for $m \leq 0$. As we shall prove later on, they are automatically orthogonal, so

$$\int_0^{2\pi} \int_0^\pi [Y_l^m(\theta, \phi)]^* [Y_{l'}^{m'}(\theta, \phi)] \sin \theta d\theta d\phi = \delta_{ll'} \delta_{mm'}. \quad [4.33]$$

In Table 4.2 I have listed the first few spherical harmonics.

***Problem 4.3** Use Equations 4.27, 4.28, and 4.32 to construct Y_0^0 and Y_2^1 . Check that they are normalized and orthogonal.

Problem 4.4 Show that

$$\Theta(\theta) = A \ln[\tan(\theta/2)]$$

satisfies the θ equation (Equation 4.25) for $l = m = 0$. This is the unacceptable “second solution”—what’s wrong with it?

***Problem 4.5** Using Equation 4.32, find $Y_l^l(\theta, \phi)$ and $Y_3^2(\theta, \phi)$. Check that they satisfy the angular equation (Equation 4.18), for the appropriate values of the parameters l and m .

****Problem 4.6** Starting from the Rodrigues formula, derive the orthonormality condition for Legendre polynomials:

$$\int_{-1}^1 P_l(x) P_{l'}(x) dx = \left(\frac{2}{2l+1}\right) \delta_{ll'}. \quad [4.34]$$

Hint: Use integration by parts.

4.1.3 The Radial Equation

Notice that the angular part of the wave function, $Y(\theta, \phi)$, is the same for all spherically symmetric potentials; the actual *shape* of the potential, $V(r)$, affects only the *radial* part of the wave function, $R(r)$, which is determined by Equation 4.16:

$$\frac{d}{dr} \left(r^2 \frac{dR}{dr} \right) - \frac{2mr^2}{\hbar^2} [V(r) - E]R = l(l+1)R. \quad [4.35]$$

This equation simplifies if we change variables: Let

$$u(r) \equiv rR(r), \quad [4.36]$$

so that $R = u/r$, $dR/dr = [r(du/dr) - u]/r^2$, $(d/dr)[r^2(dR/dr)] = rd^2u/dr^2$, and hence

$$-\frac{\hbar^2}{2m} \frac{d^2u}{dr^2} + \left[V + \frac{\hbar^2}{2m} \frac{l(l+1)}{r^2} \right] u = Eu. \quad [4.37]$$

This is called the **radial equation**⁹; it is *identical in form* to the one-dimensional Schrödinger equation (Equation 2.4), except that the effective potential,

$$V_{\text{eff}} = V + \frac{\hbar^2}{2m} \frac{l(l+1)}{r^2}, \quad [4.38]$$

contains an extra piece, the so-called **centrifugal term**, $(\hbar^2/2m)[l(l+1)/r^2]$. It tends to throw the particle outward (away from the origin), just like the centrifugal (pseudo-) force in classical mechanics. Meanwhile, the normalization condition (Equation 4.31) becomes

$$\int_0^\infty |u|^2 dr = 1. \quad [4.39]$$

We cannot proceed further until a specific potential is provided.

Example. Consider the **infinite spherical well**,

$$V(r) = \begin{cases} 0, & \text{if } r < a; \\ \infty, & \text{if } r > a. \end{cases} \quad [4.40]$$

Outside the well the wave function is zero; inside the well the radial equation says

$$\frac{d^2u}{dr^2} = \left[\frac{l(l+1)}{r^2} - k^2 \right] u, \quad [4.41]$$

⁹Those m 's are *masses*, of course—the radial equation makes no reference to the quantum number m .

where

$$k \equiv \frac{\sqrt{2mE}}{\hbar}, \quad [4.42]$$

as usual. Our problem is to solve this equation, subject to the boundary condition $u(a) = 0$. The case $l = 0$ is easy:

$$\frac{d^2u}{dr^2} = -k^2u \quad \Rightarrow \quad u(r) = A \sin(kr) + B \cos(kr).$$

But remember, the actual radial wave function is $R(r) \equiv u(r)/r$, and $[\cos(kr)]/r$ blows up as $r \rightarrow 0$. So¹⁰ we must choose $B = 0$. The boundary condition then requires $\sin(ka) = 0$, and hence $ka = n\pi$, for some integer n . The allowed energies are evidently

$$E_{n0} = \frac{n^2\pi^2\hbar^2}{2ma^2}, \quad (n = 1, 2, 3, \dots), \quad [4.43]$$

the same as for the one-dimensional infinite square well (Equation 2.23). Normalizing $u(r)$ yields $A = \sqrt{2/a}$; inclusion of the angular part (constant, in this instance, since $Y_0^0(\theta, \phi) = 1/\sqrt{4\pi}$), we conclude that

$$\psi_{n00} = \frac{1}{\sqrt{2\pi a}} \frac{\sin(n\pi r/a)}{r}. \quad [4.44]$$

[Notice that the stationary states are labeled by *three quantum numbers*, n , l , and m : $\psi_{nlm}(r, \theta, \phi)$. The *energy*, however, depends only on n and l : E_{nl} .]

The general solution to Equation 4.41 (for an arbitrary integer l) is not so familiar:

$$u(r) = Arj_l(kr) + Brn_l(kr), \quad [4.45]$$

where $j_l(x)$ is the **spherical Bessel function** of order l , and $n_l(x)$ is the **spherical Neumann function** of order l . They are defined as follows:

$$j_l(x) \equiv (-x)^l \left(\frac{1}{x} \frac{d}{dx} \right)^l \frac{\sin x}{x}; \quad n_l(x) \equiv -(-x)^l \left(\frac{1}{x} \frac{d}{dx} \right)^l \frac{\cos x}{x}. \quad [4.46]$$

For example,

$$j_0(x) = \frac{\sin x}{x}; \quad n_0(x) = -\frac{\cos x}{x};$$

$$j_1(x) = (-x) \frac{1}{x} \frac{d}{dx} \left(\frac{\sin x}{x} \right) = \frac{\sin x}{x^2} - \frac{\cos x}{x};$$

¹⁰Actually, all we require is that the wave function be *normalizable*, not that it be *finite*: $R(r) \sim 1/r$ at the origin *would* be normalizable (because of the r^2 in Equation 4.31). For a more compelling proof that $B = 0$, see R. Shankar, *Principles of Quantum Mechanics* (New York: Plenum, 1980), p. 351.

$$n_1(x) = -(-x) \frac{1}{x} \frac{d}{dx} \left(\frac{\cos x}{x} \right) = -\frac{\cos x}{x^2} - \frac{\sin x}{x};$$

and so on. The first few spherical Bessel and Neumann functions are listed in Table 4.3. Notice that for small x (where $\sin x \approx x - x^3/3! + x^5/5! - \dots$ and $\cos x \approx 1 - x^2/2 + x^4/4! - \dots$),

$$j_0(x) \approx 1; \quad n_0(x) \approx \frac{1}{x}; \quad j_1(x) \approx \frac{x}{3}; \quad n_1(x) \approx -\frac{1}{x^2};$$

etc. The point is that the Bessel functions are finite at the origin, but the Neumann functions blow up at the origin. Accordingly, we must have $B_l = 0$, and hence

$$R(r) = A j_l(kr). \tag{4.47}$$

There remains the boundary condition, $R(a) = 0$. Evidently k must be chosen such that

$$j_l(ka) = 0; \tag{4.48}$$

that is, (ka) is a zero of the l^{th} -order spherical Bessel function. Now the Bessel functions are oscillatory (see Figure 4.2); each one has an infinite number of zeros. But (unfortunately, for us) they are not located at nice sensible points (such as n , or $n\pi$, or something); they have to be computed numerically.¹¹ At any rate, the boundary condition requires that

$$k = \frac{1}{a} \beta_{nl}, \tag{4.49}$$

Table 4.3: The first few spherical Bessel and Neumann functions, $j_l(x)$ and $n_l(x)$.

| | |
|---|---|
| $j_0 = \frac{\sin x}{x}$ | $n_0 = -\frac{\cos x}{x}$ |
| $j_1 = \frac{\sin x}{x^2} - \frac{\cos x}{x}$ | $n_1 = -\frac{\cos x}{x^2} - \frac{\sin x}{x}$ |
| $j_2 = \left(\frac{3}{x^3} - \frac{1}{x} \right) \sin x - \frac{3}{x^2} \cos x$ | $n_2 = -\left(\frac{3}{x^3} - \frac{1}{x} \right) \cos x - \frac{3}{x^2} \sin x$ |
| $j_l \rightarrow \frac{x^l}{(2l+1)!!}, \quad n_l \rightarrow -\frac{(2l-1)!!}{x^{l+1}}, \quad \text{for } x \ll 1.$ | |

¹¹Abramowitz and Stegun, eds., *Handbook of Mathematical Functions* (New York: Dover, 1965), Chapter 10, provides an extensive listing.

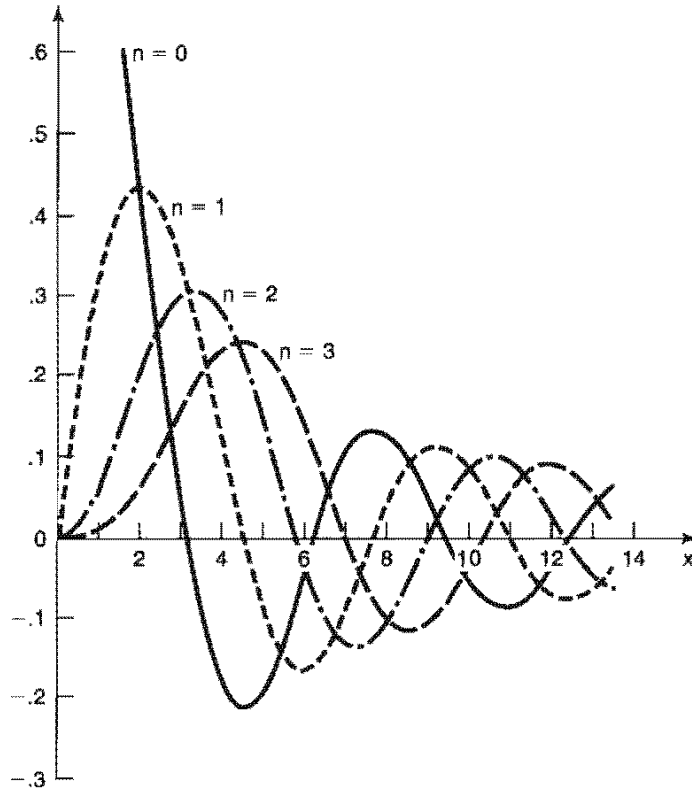

Figure 4.2: Graphs of the first four spherical Bessel functions.

where β_{nl} is the n^{th} zero of the l^{th} spherical Bessel function. The allowed energies, then, are given by

$$E_{nl} = \frac{\hbar^2}{2ma^2} \beta_{nl}^2, \quad [4.50]$$

and the wave functions are

$$\psi_{nlm}(r, \theta, \phi) = A_{nl} j_l(\beta_{nl}r/a) Y_l^m(\theta, \phi), \quad [4.51]$$

with the constant A_{nl} to be determined by normalization. Each energy level is $(2l+1)$ -fold degenerate, since there are $(2l+1)$ different values of m for each value of l (see Equation 4.29).

Problem 4.7

- (a) From the definitions (Equation 4.46), construct $j_2(x)$ and $n_2(x)$.
- (b) Expand the sines and cosines to obtain approximate formulas for $j_2(x)$ and $n_2(x)$, valid when $x \ll 1$. Confirm that $j_2(x)$ is finite at the origin but $n_2(x)$ blows up.

Problem 4.8

- (a) Check that $Arj_1(kr)$ satisfies the radial equation (Equation 4.37) with $V(r) = 0$ and $l = 1$.

- (b) Determine graphically the allowed energies for the infinite spherical well when $l = 1$. Show that for large n , $E_{n1} \approx (\hbar^2 \pi^2 / 2ma^2)(n + 1/2)^2$.

****Problem 4.9** A particle of mass m is placed in a *finite* spherical well:

$$V(r) = \begin{cases} 0, & \text{if } r \leq a; \\ V_0, & \text{if } r > a. \end{cases}$$

Find the ground state by solving the radial equation with $l = 0$. Show that there is no bound state at all if $V_0 a^2 < \pi^2 \hbar^2 / 8m$.

4.2 THE HYDROGEN ATOM

The hydrogen atom consists of a heavy, essentially motionless proton (we may as well put it at the origin) of charge e , together with a much lighter electron (charge $-e$) that circles around it, held in orbit by the mutual attraction of opposite charges (see Figure 4.3). From Coulomb's law, the potential energy (in SI units) is

$$V(r) = -\frac{e^2}{4\pi\epsilon_0 r}, \quad [4.52]$$

and the radial equation (Equation 4.37) says

$$-\frac{\hbar^2}{2m} \frac{d^2 u}{dr^2} + \left[-\frac{e^2}{4\pi\epsilon_0 r} + \frac{\hbar^2 l(l+1)}{2m r^2} \right] u = Eu. \quad [4.53]$$

Our problem is to solve this equation for $u(r)$ and determine the allowed electron energies E . The hydrogen atom is such an important case that I'm not going to hand you the solutions this time—we'll work them out in detail by the method we used in the analytical solution to the harmonic oscillator. (If any step in this process is unclear, you may wish to refer back to Section 2.3.2 for a more complete explanation.) Incidentally, the Coulomb potential (Equation 4.52) admits *continuum* states (with $E > 0$), describing electron-proton scattering, as well as discrete *bound* states, representing the hydrogen atom, but we shall confine our attention to the latter.

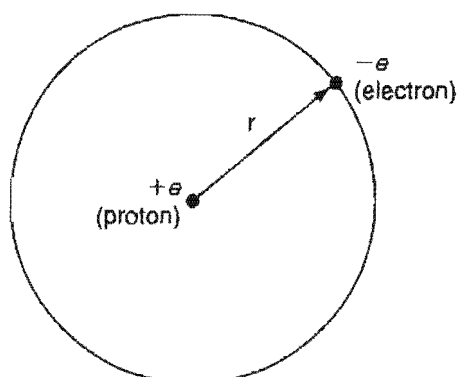

Figure 4.3: The hydrogen atom.

4.2.1 The Radial Wave Function

Our first task is to tidy up the notation. Let

$$\kappa \equiv \frac{\sqrt{-2mE}}{\hbar}. \quad [4.54]$$

(For bound states, $E < 0$, so κ is real.) Dividing Equation 4.53 by E , we have

$$\frac{1}{\kappa^2} \frac{d^2 u}{dr^2} = \left[1 - \frac{me^2}{2\pi\epsilon_0\hbar^2\kappa} \frac{1}{(\kappa r)} + \frac{l(l+1)}{(\kappa r)^2} \right] u.$$

This suggests that we let

$$\rho \equiv \kappa r, \quad \text{and} \quad \rho_0 \equiv \frac{me^2}{2\pi\epsilon_0\hbar^2\kappa}, \quad [4.55]$$

so that

$$\frac{d^2 u}{d\rho^2} = \left[1 - \frac{\rho_0}{\rho} + \frac{l(l+1)}{\rho^2} \right] u. \quad [4.56]$$

Next we examine the asymptotic form of the solutions. As $\rho \rightarrow \infty$, the constant term in the brackets dominates, so (approximately)

$$\frac{d^2 u}{d\rho^2} = u.$$

The general solution is

$$u(\rho) = Ae^{-\rho} + Be^{\rho}, \quad [4.57]$$

but e^{ρ} blows up (as $\rho \rightarrow \infty$), so $B = 0$. Evidently,

$$u(\rho) \sim Ae^{-\rho} \quad [4.58]$$

for large ρ . On the other hand, as $\rho \rightarrow 0$ the centrifugal term dominates¹²; approximately, then,

$$\frac{d^2 u}{d\rho^2} = \frac{l(l+1)}{\rho^2} u.$$

The general solution (check it!) is

$$u(\rho) = C\rho^{l+1} + D\rho^{-l},$$

but ρ^{-l} blows up (as $\rho \rightarrow 0$), so $D = 0$. Thus

$$u(\rho) \sim C\rho^{l+1} \quad [4.59]$$

¹²This argument does not apply when $l = 0$ (although the conclusion, Equation 4.59, is in fact valid for that case too). But never mind: All I am trying to do is provide some *motivation* for a change of variables (Equation 4.60.)

for small ρ .

The next step is to peel off the asymptotic behavior, introducing the new function $v(\rho)$:

$$u(\rho) = \rho^{l+1} e^{-\rho} v(\rho), \quad [4.60]$$

in the hope that $v(\rho)$ will turn out to be simpler than $u(\rho)$. The first indications are not auspicious:

$$\frac{du}{d\rho} = \rho^l e^{-\rho} \left[(l+1-\rho)v + \rho \frac{dv}{d\rho} \right],$$

and

$$\frac{d^2u}{d\rho^2} = \rho^l e^{-\rho} \left\{ \left[-2l - 2 + \rho + \frac{l(l+1)}{\rho} \right] v + 2(l+1-\rho) \frac{dv}{d\rho} + \rho \frac{d^2v}{d\rho^2} \right\}.$$

In terms of $v(\rho)$, then, the radial equation (Equation 4.56) reads

$$\rho \frac{d^2v}{d\rho^2} + 2(l+1-\rho) \frac{dv}{d\rho} + [\rho_0 - 2(l+1)]v = 0. \quad [4.61]$$

Finally, we assume the solution, $v(\rho)$, can be expressed as a power series in ρ :

$$v(\rho) = \sum_{j=0}^{\infty} a_j \rho^j. \quad [4.62]$$

Our problem is to determine the coefficients (a_0, a_1, a_2, \dots). Differentiating term by term,

$$\frac{dv}{d\rho} = \sum_{j=0}^{\infty} j a_j \rho^{j-1} = \sum_{j=0}^{\infty} (j+1) a_{j+1} \rho^j.$$

[In the second summation I have renamed the “dummy index”: $j \rightarrow j+1$. If this troubles you, write out the first few terms explicitly, and *check* it. You might say that the sum should now begin at $j = -1$, but the factor $(j+1)$ kills that term anyway, so we might as well start at zero.] Differentiating again,

$$\frac{d^2v}{d\rho^2} = \sum_{j=0}^{\infty} j(j+1) a_{j+1} \rho^{j-1}.$$

Inserting these into Equation 4.61, we have

$$\begin{aligned} \sum_{j=0}^{\infty} j(j+1) a_{j+1} \rho^j + 2(l+1) \sum_{j=0}^{\infty} (j+1) a_{j+1} \rho^j \\ - 2 \sum_{j=0}^{\infty} j a_j \rho^j + [\rho_0 - 2(l+1)] \sum_{j=0}^{\infty} a_j \rho^j = 0. \end{aligned}$$

Equating the coefficients of like powers yields

$$j(j+1)a_{j+1} + 2(l+1)(j+1)a_{j+1} - 2ja_j + [\rho_0 - 2(l+1)]a_j = 0,$$

or

$$a_{j+1} = \left\{ \frac{2(j+l+1) - \rho_0}{(j+1)(j+2l+2)} \right\} a_j. \quad [4.63]$$

This recursion formula determines the coefficients, and hence the function $v(\rho)$: We start with $a_0 = A$ (this becomes an overall constant, to be fixed eventually by normalization), and Equation 4.63 gives us a_1 ; putting this back in, we obtain a_2 , and so on.¹³

Now let's see what the coefficients look like for large j (this corresponds to large ρ , where the higher powers dominate). In this regime the recursion formula says

$$a_{j+1} \cong \frac{2j}{j(j+1)} a_j = \frac{2}{j+1} a_j,$$

so

$$a_j \cong \frac{2^j}{j!} A. \quad [4.64]$$

Suppose for a moment that this were the *exact* result. Then

$$v(\rho) = A \sum_{j=0}^{\infty} \frac{2^j}{j!} \rho^j = A e^{2\rho},$$

and hence

$$u(\rho) = A \rho^{l+1} e^{\rho}, \quad [4.65]$$

which blows up at large ρ . The positive exponential is precisely the asymptotic behavior we *didn't* want in Equation 4.57. (It's no accident that it reappears here; after all, it *does* represent the asymptotic form of *some* solutions to the radial equation—they just don't happen to be the ones we're interested in, because they aren't normalizable.) There is only one way out of this dilemma: *The series must terminate*. There must occur some maximal integer, j_{\max} , such that

$$a_{j_{\max}+1} = 0 \quad [4.66]$$

(and beyond which all coefficients vanish automatically). Evidently (Equation 4.63)

$$2(j_{\max} + l + 1) - \rho_0 = 0.$$

¹³You might wonder why I didn't use the series method directly on $u(\rho)$ —why factor out the asymptotic behavior before applying this procedure? The reason for peeling off ρ^{l+1} is largely aesthetic: Without this, the sequence would begin with a long string of zeroes (the first nonzero coefficient being a_{l+1}); by factoring out ρ^{l+1} we obtain a series that starts out with ρ^0 . The $e^{-\rho}$ factor is more critical—if you *don't* pull that out, you get a three-term recursion formula involving a_{j+2} , a_{j+1} , and a_j (try it!), and that is enormously more difficult to work with.

Defining

$$n \equiv j_{\max} + l + 1 \quad [4.67]$$

(the so-called **principal quantum number**), we have

$$\rho_0 = 2n. \quad [4.68]$$

But ρ_0 determines E (Equations 4.54 and 4.55):

$$E = -\frac{\hbar^2 \kappa^2}{2m} = -\frac{me^4}{8\pi^2 \epsilon_0^2 \hbar^2 \rho_0^2}, \quad [4.69]$$

so the allowed energies are

$$E_n = -\left[\frac{m}{2\hbar^2} \left(\frac{e^2}{4\pi\epsilon_0} \right)^2 \right] \frac{1}{n^2} = \frac{E_1}{n^2}, \quad n = 1, 2, 3, \dots \quad [4.70]$$

This is the famous **Bohr formula**—by any measure the most important result in all of quantum mechanics. Bohr obtained it in 1913 by a serendipitous mixture of inapplicable classical physics and premature quantum theory (the Schrödinger equation did not come until 1924).

Combining Equations 4.55 and 4.68, we find that

$$\kappa = \left(\frac{me^2}{4\pi\epsilon_0\hbar^2} \right) \frac{1}{n} = \frac{1}{an}, \quad [4.71]$$

where

$$a \equiv \frac{4\pi\epsilon_0\hbar^2}{me^2} = 0.529 \times 10^{-10} \text{ m} \quad [4.72]$$

is the so-called **Bohr radius**. It follows (again, from Equation 4.55) that

$$\rho = \frac{r}{an}. \quad [4.73]$$

Evidently the spatial wave functions for hydrogen are labeled by three quantum numbers (n , l , and m):

$$\psi_{nlm}(r, \theta, \phi) = R_{nl}(r) Y_l^m(\theta, \phi), \quad [4.74]$$

where (referring back to Equations 4.36 and 4.60)

$$R_{nl}(r) = \frac{1}{r} \rho^{l+1} e^{-\rho} v(\rho), \quad [4.75]$$

and $v(\rho)$ is a polynomial of degree $j_{\max} = n - l - 1$ in ρ , whose coefficients are determined (up to an overall normalization factor) by the recursion formula

$$a_{j+1} = \frac{2(j+l+1-n)}{(j+1)(j+2l+2)} a_j. \quad [4.76]$$

The **ground state** (that is, the state of lowest energy) is the case $n = 1$; putting in the accepted values for the physical constants, we get

$$E_1 = - \left[\frac{m}{2\hbar^2} \left(\frac{e^2}{4\pi\epsilon_0} \right)^2 \right] = -13.6 \text{ eV}. \quad [4.77]$$

Evidently the **binding energy** of hydrogen (the amount of energy you would have to impart to the electron in order to ionize the atom) is 13.6 eV. Equation 4.67 forces $l = 0$, whence also $m = 0$ (see Equation 4.29), so

$$\psi_{100}(r, \theta, \phi) = R_{10}(r) Y_0^0(\theta, \phi). \quad [4.78]$$

The recursion formula truncates after the first term (Equation 4.76 with $j = 0$ yields $a_1 = 0$), so $v(\rho)$ is a constant (a_0) and

$$R_{10}(r) = \frac{a_0}{a} e^{-r/a}. \quad [4.79]$$

Normalizing it, in accordance with Equation 4.31,

$$\int_0^\infty |R_{10}|^2 r^2 dr = \frac{|a_0|^2}{a^2} \int_0^\infty e^{-2r/a} r^2 dr = |a_0|^2 \frac{a}{4} = 1,$$

so $a_0 = 2/\sqrt{a}$. Meanwhile, $Y_0^0 = 1/\sqrt{4\pi}$, so

$$\psi_{100}(r, \theta, \phi) = \frac{1}{\sqrt{\pi a^3}} e^{-r/a}. \quad [4.80]$$

If $n = 2$ the energy is

$$E_2 = \frac{-13.6 \text{ eV}}{4} = -3.4 \text{ eV}; \quad [4.81]$$

this is the first excited state—or rather, *states*, since we can have either $l = 0$ (in which case $m = 0$) or $l = 1$ (with $m = -1, 0$, or $+1$), so there are actually four different states that share this energy. If $l = 0$, the recursion relation (Equation 4.76) gives

$$a_1 = -a_0 \text{ (using } j = 0\text{), and } a_2 = 0 \text{ (using } j = 1\text{),}$$

so $v(\rho) = a_0(1 - \rho)$, and hence

$$R_{20}(r) = \frac{a_0}{2a} \left(1 - \frac{r}{2a}\right) e^{-r/2a}. \quad [4.82]$$

If $l = 1$ the recursion formula terminates the series after a single term, so $v(\rho)$ is a constant, and we find

$$R_{21}(r) = \frac{a_0}{4a^2} r e^{-r/2a}. \quad [4.83]$$

(In each case the constant a_0 is to be determined by normalization—see Problem 4.11.)

For arbitrary n , the possible values of l (consistent with Equation 4.67) are

$$l = 0, 1, 2, \dots, n - 1. \quad [4.84]$$

For each l , there are $(2l + 1)$ possible values of m (Equation 4.29), so the total degeneracy of the energy level E_n is

$$d(n) = \sum_{l=0}^{n-1} (2l + 1) = n^2. \quad [4.85]$$

The polynomial $v(\rho)$ (defined by the recursion formula, Equation 4.76) is a function well known to applied mathematicians; apart from normalization, it can be written as

$$v(\rho) = L_{n-l-1}^{2l+1}(2\rho), \quad [4.86]$$

where

$$L_{q-p}^p(x) \equiv (-1)^p \left(\frac{d}{dx}\right)^p L_q(x) \quad [4.87]$$

is an **associated Laguerre polynomial**, and

$$L_q(x) \equiv e^x \left(\frac{d}{dx}\right)^q (e^{-x} x^q) \quad [4.88]$$

is the q th **Laguerre polynomial**.¹⁴ (The first few Laguerre polynomials are listed in Table 4.4; some associated Laguerre polynomials are given in Table 4.5. The first few radial wave functions are listed in Table 4.6 and plotted in Figure 4.4.) The normalized hydrogen wave functions are¹⁵

$$\psi_{nlm} = \sqrt{\left(\frac{2}{na}\right)^3 \frac{(n-l-1)!}{2n[(n+l)!]^3}} e^{-r/na} \left(\frac{2r}{na}\right)^l L_{n-l-1}^{2l+1}\left(\frac{2r}{na}\right) Y_l^m(\theta, \phi). \quad [4.89]$$

¹⁴As usual, there are rival normalization conventions in the literature; I have adopted the most nearly standard one.

¹⁵If you want to see how the normalization factor is calculated, study (for example), L. Schiff, *Quantum Mechanics*, 2nd ed. (New York: McGraw-Hill, 1968), page 93.

Table 4.4: The first few Laguerre polynomials, $L_q(x)$.

$$L_0 = 1$$

$$L_1 = -x + 1$$

$$L_2 = x^2 - 4x + 2$$

$$L_3 = -x^3 + 9x^2 - 18x + 6$$

$$L_4 = x^4 - 16x^3 + 72x^2 - 96x + 24$$

$$L_5 = -x^5 + 25x^4 - 200x^3 + 600x^2 - 600x + 120$$

$$L_6 = x^6 - 36x^5 + 450x^4 - 2400x^3 + 5400x^2 - 4320x + 720$$

Table 4.5: Some associated Laguerre polynomials, $L_{q-p}^p(x)$.

$$L_0^0 = 1$$

$$L_0^2 = 2$$

$$L_1^0 = -x + 1$$

$$L_1^2 = -6x + 18$$

$$L_2^0 = x^2 - 4x + 2$$

$$L_2^2 = 12x^2 - 96x + 144$$

$$L_0^1 = 1$$

$$L_0^3 = 6$$

$$L_1^1 = -2x + 4$$

$$L_1^3 = -24x + 96$$

$$L_2^1 = 3x^2 - 18x + 18$$

$$L_2^3 = 60x^2 - 600x + 1200$$

They are not pretty, but don't complain—this is one of the very few realistic systems that can be solved at all, in exact closed form. As we will prove later on, they are mutually orthogonal:

$$\int \psi_{nlm}^* \psi_{n'l'm'} r^2 \sin \theta dr d\theta d\phi = \delta_{nn'} \delta_{ll'} \delta_{mm'}. \quad [4.90]$$

***Problem 4.10** Work out the radial wave functions R_{30} , R_{31} , and R_{32} , using the recursion formula (Equation 4.76). Don't bother to normalize them.

***Problem 4.11**

(a) Normalize R_{20} (Equation 4.82), and construct the function ψ_{200} .

(b) Normalize R_{21} (Equation 4.83), and construct ψ_{211} , ψ_{210} , and ψ_{21-1} .

****Problem 4.12**

(a) Using Equation 4.88, work out the first four Laguerre polynomials.

(b) Using Equations 4.86, 4.87, and 4.88, find $v(\rho)$ for the case $n = 5$, $l = 2$.

Table 4.6: The first few radial wave functions for hydrogen, $R_{nl}(r)$.

| |
|--|
| $R_{10} = 2a^{-3/2} \exp(-r/a)$ |
| $R_{20} = \frac{1}{\sqrt{2}} a^{-3/2} \left(1 - \frac{1}{2} \frac{r}{a}\right) \exp(-r/2a)$ |
| $R_{21} = \frac{1}{\sqrt{24}} a^{-3/2} \frac{r}{a} \exp(-r/2a)$ |
| $R_{30} = \frac{2}{\sqrt{27}} a^{-3/2} \left(1 - \frac{2r}{3a} + \frac{2}{27} \left(\frac{r}{a}\right)^2\right) \exp(-r/3a)$ |
| $R_{31} = \frac{8}{27\sqrt{6}} a^{-3/2} \left(1 - \frac{1}{6} \frac{r}{a}\right) \left(\frac{r}{a}\right) \exp(-r/3a)$ |
| $R_{32} = \frac{4}{81\sqrt{30}} a^{-3/2} \left(\frac{r}{a}\right)^2 \exp(-r/3a)$ |
| $R_{40} = \frac{1}{4} a^{-3/2} \left(1 - \frac{3r}{4a} + \frac{1}{8} \left(\frac{r}{a}\right)^2 - \frac{1}{192} \left(\frac{r}{a}\right)^3\right) \exp(-r/4a)$ |
| $R_{41} = \frac{\sqrt{5}}{16\sqrt{3}} a^{-3/2} \left(1 - \frac{1}{4} \frac{r}{a} + \frac{1}{80} \left(\frac{r}{a}\right)^2\right) \frac{r}{a} \exp(-r/4a)$ |
| $R_{42} = \frac{1}{64\sqrt{5}} a^{-3/2} \left(1 - \frac{1}{12} \frac{r}{a}\right) \left(\frac{r}{a}\right)^2 \exp(-r/4a)$ |
| $R_{43} = \frac{1}{768\sqrt{35}} a^{-3/2} \left(\frac{r}{a}\right)^3 \exp(-r/4a)$ |

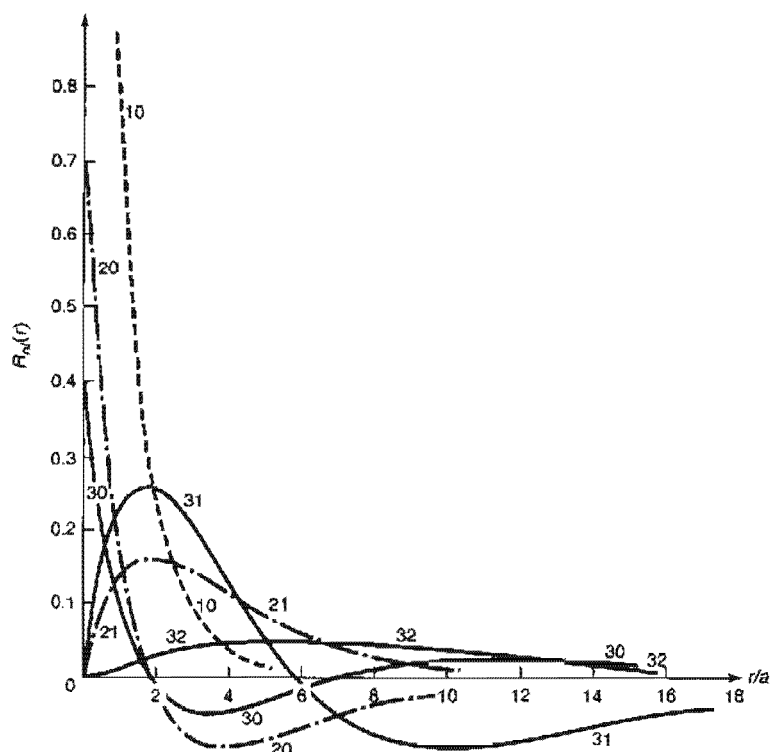
Figure 4.4: Graphs of the first few hydrogen radial wave functions, $R_{nl}(r)$.

- (c) Again, find $v(\rho)$ for the case $n = 5, l = 2$, but this time get it from the recursion formula (Equation 4.76).

***Problem 4.13**

- (a) Find $\langle r \rangle$ and $\langle r^2 \rangle$ for an electron in the ground state of hydrogen. Express your answers in terms of the Bohr radius a .
- (b) Find $\langle x \rangle$ and $\langle x^2 \rangle$ for an electron in the ground state of hydrogen. *Hint:* This requires no new integration—note that $r^2 = x^2 + y^2 + z^2$, and exploit the symmetry of the ground state.
- (c) Find $\langle x^2 \rangle$ in the state $n = 2, l = 1, m = 1$. *Hint:* This state is *not* symmetrical in x, y, z . Use $x = r \sin \theta \cos \phi$.

Problem 4.14 What is the probability that an electron in the ground state of hydrogen will be found *inside the nucleus*?

- (a) First calculate the *exact* answer, assuming that the wave function (Equation 4.80) is correct all the way down to $r = 0$. Let b be the radius of the nucleus.
- (b) Expand your result as a power series in the small number $\varepsilon \equiv 2b/a$, and show that the lowest-order term is the cubic: $P \approx (4/3)(b/a)^3$. This should be a suitable approximation, provided that $b \ll a$ (which it is).
- (c) Alternatively, we might assume that $\psi(r)$ is essentially constant over the (tiny) volume of the nucleus, so that $P \approx (4/3)\pi b^3 |\psi(0)|^2$. Check that you get the same answer this way.
- (d) Use $b \approx 10^{-15}$ m and $a \approx 0.5 \times 10^{-10}$ m to get a numerical estimate for P . Roughly speaking, this represents the “fraction of its time that the electron spends inside the nucleus”.

Problem 4.15

- (a) Use the recursion formula (Equation 4.76) to confirm that when $l = n - 1$ the radial wave function takes the form

$$R_{n(n-1)} = N_n r^{n-1} e^{-r/na},$$

and determine the normalization constant N_n by direct integration.

- (b) Calculate $\langle r \rangle$ and $\langle r^2 \rangle$ for states of the form $\psi_{n(n-1)m}$.
- (c) Show that $\sigma_r = \langle r \rangle / \sqrt{2n + 1}$ for such states. Note that the fractional spread in r decreases with increasing n (in this sense the system “begins to look classical” for large n). Sketch the radial wave functions for several values of n to illustrate this point.

4.2.2 The Spectrum of Hydrogen

In principle, if you put a hydrogen atom into some stationary state Ψ_{nlm} , it should stay there forever. However, if you *tickle* it slightly (by collision with another atom, say, or by shining light on it), then the atom may undergo a **transition** to some other stationary state—either by *absorbing* energy and moving up to a higher-energy state, or by *giving off* energy (typically in the form of electromagnetic radiation) and moving down.¹⁶ In practice such perturbations are *always* present; transitions (or, as they are sometimes called, “quantum jumps”) are constantly occurring, and the result is that a container of hydrogen gives off light (photons), whose energy corresponds to the *difference* in energy between the initial and final states:

$$E_\gamma = E_i - E_f = -13.6 \text{ eV} \left(\frac{1}{n_i^2} - \frac{1}{n_f^2} \right). \quad [4.91]$$

Now, according to the **Planck formula**,¹⁷ the energy of a photon is proportional to its frequency:

$$E_\gamma = h\nu. \quad [4.92]$$

Meanwhile, the *wavelength* is given by $\lambda = c/\nu$, so

$$\frac{1}{\lambda} = R \left(\frac{1}{n_f^2} - \frac{1}{n_i^2} \right), \quad [4.93]$$

where

$$R \equiv \frac{m}{4\pi c\hbar^3} \left(\frac{e^2}{4\pi\epsilon_0} \right)^2 = 1.097 \times 10^7 \text{ m}^{-1}. \quad [4.94]$$

R is known as the **Rydberg constant**, and Equation 4.93 is the **Rydberg formula** for the spectrum of hydrogen. It was discovered empirically in the nineteenth century, and the greatest triumph of Bohr’s theory was its ability to account for this result—and to calculate R in terms of the fundamental constants of nature. Transitions to the ground state ($n_f = 1$) lie in the ultraviolet; they are known to spectroscopists as the **Lyman series**. Transitions to the first excited state ($n_f = 2$) fall in the visible region; they constitute the **Balmer series**. Transitions to $n_f = 3$ (the **Paschen series**) are in the infrared, and so on (see Figure 4.5). (At room temperature, most hydrogen atoms are in the ground state; to obtain the emission spectrum, you must first pump them up into the various excited states; typically this is done by passing an electric spark through the gas.)

¹⁶By its nature, this involves a time-dependent interaction, and the details will have to wait for Chapter 9; for our present purposes the actual mechanism involved is immaterial.

¹⁷The photon is a quantum of electromagnetic radiation; it’s a relativistic object if there ever was one, and therefore outside the scope of nonrelativistic quantum mechanics. It will be useful in a few places to speak of photons and to invoke the Planck formula for their energy, but please bear in mind that this is external to the theory we are developing.

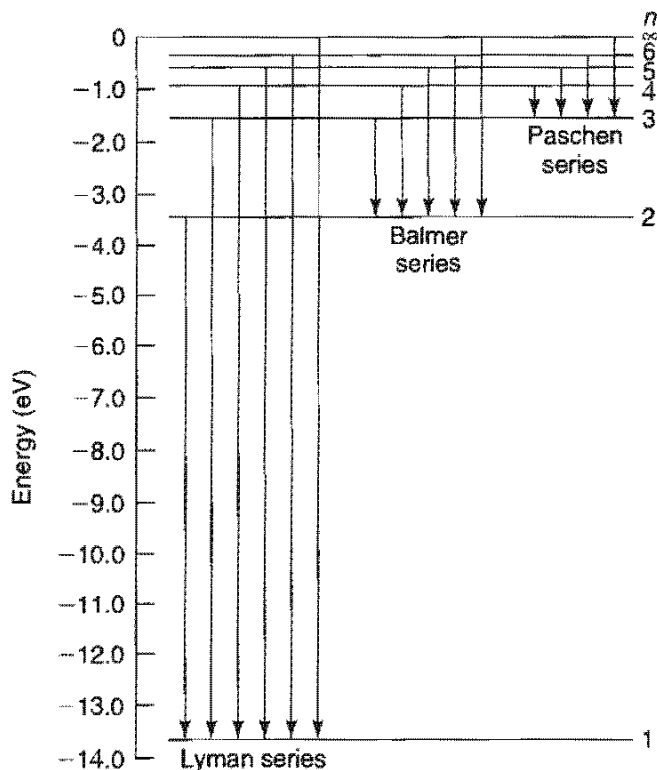

Figure 4.5: Energy levels and transitions in the spectrum of hydrogen.

Problem 4.16 Consider the earth-sun system as a gravitational analog to the hydrogen atom.

- What is the potential energy function (replacing Equation 4.52)? (Let m be the mass of the earth and M the mass of the sun.)
- What is the “Bohr radius” for this system? Work out the actual numerical value.
- Write down the gravitational “Bohr formula”, and, by equating E_n to the classical energy of a planet in a circular orbit of radius r_0 , show that $n = \sqrt{r_0/a}$. From this, estimate the quantum number n of the earth.
- Suppose the earth made a transition to the next lower level ($n - 1$). How much energy (in Joules) would be released? What would the wavelength of the emitted photon (or, more likely, graviton) be?

***Problem 4.17** A **hydrogenic atom** consists of a single electron orbiting a nucleus with Z protons. ($Z = 1$ would be hydrogen itself, $Z = 2$ is ionized helium, $Z = 3$ is doubly ionized lithium, and so on.) Determine the Bohr energies $E_n(Z)$, the binding energy $E_1(Z)$, the Bohr radius $a(Z)$, and the Rydberg constant $R(Z)$ for a hydrogenic atom. (Express your answers as appropriate multiples of the hydrogen values.) Where in the electromagnetic spectrum would the Lyman series fall, for $Z = 2$ and $Z = 3$?

4.3 ANGULAR MOMENTUM

In classical mechanics, the angular momentum of a particle (with respect to the origin) is given by the formula

$$\mathbf{L} = \mathbf{r} \times \mathbf{p}, \quad [4.95]$$

which is to say,

$$L_x = yp_z - zp_y, \quad L_y = zp_x - xp_z, \quad \text{and} \quad L_z = xp_y - yp_x. \quad [4.96]$$

The corresponding quantum operators are obtained by the standard prescription (Equation 4.2):

$$\begin{aligned} L_x &= \frac{\hbar}{i} \left(y \frac{\partial}{\partial z} - z \frac{\partial}{\partial y} \right); \quad L_y = \frac{\hbar}{i} \left(z \frac{\partial}{\partial x} - x \frac{\partial}{\partial z} \right); \\ L_z &= \frac{\hbar}{i} \left(x \frac{\partial}{\partial y} - y \frac{\partial}{\partial x} \right). \end{aligned} \quad [4.97]$$

In the following sections we will deduce the eigenvalues and eigenfunctions of these operators.

4.3.1 Eigenvalues

L_x and L_y do not commute; in fact [providing a test function, $f(x, y, z)$, for them to act upon]:

$$\begin{aligned} [L_x, L_y]f &= \left(\frac{\hbar}{i} \right)^2 \left\{ \left(y \frac{\partial}{\partial z} - z \frac{\partial}{\partial y} \right) \left(z \frac{\partial}{\partial x} - x \frac{\partial}{\partial z} \right) f \right. \\ &\quad \left. - \left(z \frac{\partial}{\partial x} - x \frac{\partial}{\partial z} \right) \left(y \frac{\partial}{\partial z} - z \frac{\partial}{\partial y} \right) f \right\} \\ &= \left(\frac{\hbar}{i} \right)^2 \left\{ y \frac{\partial}{\partial z} \left(z \frac{\partial f}{\partial x} \right) - y \frac{\partial}{\partial z} \left(x \frac{\partial f}{\partial z} \right) \right. \\ &\quad \left. - z \frac{\partial}{\partial y} \left(z \frac{\partial f}{\partial x} \right) + z \frac{\partial}{\partial y} \left(x \frac{\partial f}{\partial z} \right) - z \frac{\partial}{\partial x} \left(y \frac{\partial f}{\partial z} \right) \right. \\ &\quad \left. + z \frac{\partial}{\partial x} \left(z \frac{\partial f}{\partial y} \right) + x \frac{\partial}{\partial z} \left(y \frac{\partial f}{\partial z} \right) - x \frac{\partial}{\partial z} \left(z \frac{\partial f}{\partial y} \right) \right\} \\ &= \left(\frac{\hbar}{i} \right)^2 \left(y \frac{\partial f}{\partial x} + yz \frac{\partial^2 f}{\partial z \partial x} - yx \frac{\partial^2 f}{\partial z^2} - z^2 \frac{\partial^2 f}{\partial y \partial x} + zx \frac{\partial^2 f}{\partial y \partial z} \right. \\ &\quad \left. - zy \frac{\partial^2 f}{\partial x \partial z} + z^2 \frac{\partial^2 f}{\partial x \partial y} + xy \frac{\partial^2 f}{\partial z^2} - x \frac{\partial f}{\partial y} - xz \frac{\partial^2 f}{\partial z \partial y} \right). \end{aligned}$$

All the terms cancel in pairs (by virtue of the equality of cross-derivatives) except two:

$$[L_x, L_y]f = \left(\frac{\hbar}{i}\right)^2 \left(y \frac{\partial}{\partial x} - x \frac{\partial}{\partial y}\right) f = i\hbar L_z f,$$

and we conclude (dropping the test function)

$$[L_x, L_y] = i\hbar L_z. \quad [4.98]$$

By cyclic permutation of the indices it follows also that

$$[L_y, L_z] = i\hbar L_x \quad \text{and} \quad [L_z, L_x] = i\hbar L_y. \quad [4.99]$$

From these fundamental commutation relations the entire theory of angular momentum can be deduced.

Evidently L_x , L_y , and L_z are *incompatible* observables. According to the generalized uncertainty principle (Equation 3.139),

$$\sigma_{L_x}^2 \sigma_{L_y}^2 \geq \left(\frac{1}{2i} \langle i\hbar L_z \rangle\right)^2 = \frac{\hbar^2}{4} \langle L_z \rangle^2,$$

or

$$\sigma_{L_x} \sigma_{L_y} \geq \frac{\hbar}{2} |\langle L_z \rangle|. \quad [4.100]$$

It would therefore be futile to look for states that are simultaneously eigenfunctions of L_x and of L_y . On the other hand, the *square* of the *total* angular momentum,

$$L^2 \equiv L_x^2 + L_y^2 + L_z^2, \quad [4.101]$$

does commute with L_x :

$$\begin{aligned} [L^2, L_x] &= [L_x^2, L_x] + [L_y^2, L_x] + [L_z^2, L_x] \\ &= L_y[L_y, L_x] + [L_y, L_x]L_y + L_z[L_z, L_x] + [L_z, L_x]L_z \\ &= L_y(-i\hbar L_z) + (-i\hbar L_z)L_y + L_z(i\hbar L_y) + (i\hbar L_y)L_z \\ &= 0. \end{aligned}$$

(I used Equation 3.142 and the fact that *any* operator commutes with *itself*.¹⁸) It follows, of course, that L^2 also commutes with L_y and L_z :

$$[L^2, L_x] = 0, \quad [L^2, L_y] = 0, \quad [L^2, L_z] = 0, \quad [4.102]$$

¹⁸Note that all the operators we encounter in quantum mechanics (see footnote 8, Chapter 1) are **linear**, in the sense that $\hat{A}(f + g) = \hat{A}f + \hat{A}g$, and therefore *distributive* with respect to addition: $\hat{A}(\hat{B} + \hat{C}) = \hat{A}\hat{B} + \hat{A}\hat{C}$. In particular, $[\hat{A}, \hat{B} + \hat{C}] = [\hat{A}, \hat{B}] + [\hat{A}, \hat{C}]$.

or, more compactly,

$$[L^2, \mathbf{L}] = 0. \quad [4.103]$$

So L^2 is compatible with each component of \mathbf{L} , and we *can* hope to find simultaneous eigenstates of L^2 and (say) L_z :

$$L^2 f = \lambda f \quad \text{and} \quad L_z f = \mu f. \quad [4.104]$$

We'll use a "ladder operator" technique, very similar to the one we applied to the harmonic oscillator back in Section 2.3.1. Let

$$L_{\pm} \equiv L_x \pm iL_y. \quad [4.105]$$

Its commutator with L_z is

$$[L_z, L_{\pm}] = [L_z, L_x] \pm i[L_z, L_y] = i\hbar L_y \pm i(-i\hbar L_x) = \pm\hbar(L_x \pm iL_y),$$

so

$$[L_z, L_{\pm}] = \pm\hbar L_{\pm}. \quad [4.106]$$

And, of course,

$$[L^2, L_{\pm}] = 0. \quad [4.107]$$

I claim that if f is an eigenfunction of L^2 and L_z , so also is $L_{\pm}f$. For Equation 4.107 says

$$L^2(L_{\pm}f) = L_{\pm}(L^2f) = L_{\pm}(\lambda f) = \lambda(L_{\pm}f), \quad [4.108]$$

so $L_{\pm}f$ is an eigenfunction of L^2 , with the same eigenvalue λ , and Equation 4.106 says

$$\begin{aligned} L_z(L_{\pm}f) &= (L_z L_{\pm} - L_{\pm} L_z)f + L_{\pm} L_z f = \pm\hbar L_{\pm}f + L_{\pm}(\mu f) \\ &= (\mu \pm \hbar)(L_{\pm}f), \end{aligned} \quad [4.109]$$

so $L_{\pm}f$ is an eigenfunction of L_z with the *new* eigenvalue $\mu \pm \hbar$. L_+ is called the "raising" operator because it *increases* the eigenvalue of L_z by \hbar , and L_- is called the "lowering" operator because it *lowers* the eigenvalue by \hbar .

For a given value of λ , then, we obtain a "ladder" of states, with each "rung" separated from its neighbors by one unit of \hbar in the eigenvalue of L_z (see Figure 4.6). To ascend the ladder we apply the raising operator, and to descend, the lowering operator. But this process cannot go on forever: Eventually we're going to reach a state for which the z -component exceeds the *total*, and that cannot be (see Problem 4.18). So there must exist a "top rung," f_t , such that¹⁹

$$L_+ f_t = 0. \quad [4.110]$$

¹⁹Actually, all we can conclude is that $L_+ f_t$ is *not normalizable*—its norm could be *infinite*, instead of zero. Problem 4.19 eliminates this alternative.

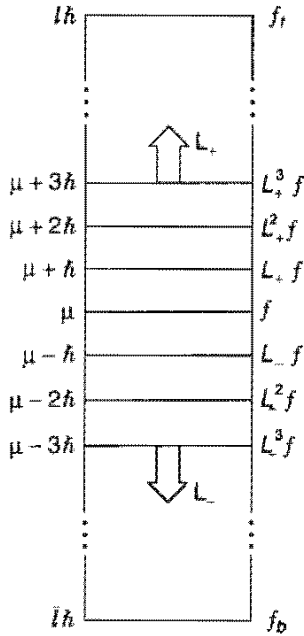

Figure 4.6: The “ladder” of angular momentum states.

Let $\hbar l$ be the eigenvalue of L_z at this top rung (the appropriateness of the letter l —sometimes called the **azimuthal quantum number**—will appear in a moment):

$$L_z f_t = \hbar l f_t; \quad L^2 f_t = \lambda f_t. \quad [4.111]$$

Now

$$\begin{aligned} L_{\pm} L_{\mp} &= (L_x \pm iL_y)(L_x \mp iL_y) = L_x^2 + L_y^2 \mp i(L_x L_y - L_y L_x) \\ &= L^2 - L_z^2 \mp i(\hbar L_z), \end{aligned}$$

or, putting it the other way around,

$$L^2 = L_{\pm} L_{\mp} + L_z^2 \mp \hbar L_z. \quad [4.112]$$

It follows that

$$L^2 f_t = (L_- L_+ + L_z^2 + \hbar L_z) f_t = (0 + \hbar^2 l^2 + \hbar^2 l) f_t = \hbar^2 l(l+1) f_t,$$

and hence

$$\lambda = \hbar^2 l(l+1). \quad [4.113]$$

This tells us the eigenvalue of L^2 in terms of the maximum eigenvalue of L_z .

Meanwhile, there is also (for the same reason) a *bottom* rung, f_b , such that

$$L_- f_b = 0. \quad [4.114]$$

Let $\hbar \bar{l}$ be the eigenvalue of L_z at this bottom rung:

$$L_z f_b = \hbar \bar{l} f_b; \quad L^2 f_b = \lambda f_b. \quad [4.115]$$

Using Equation 4.112, we have

$$L^2 f_b = (L_+ L_- + L_z^2 - \hbar L_z) f_b = (0 + \hbar^2 \bar{l}^2 - \hbar^2 \bar{l}) f_b = \hbar^2 \bar{l}(\bar{l} - 1) f_b,$$

and therefore

$$\lambda = \hbar^2 \bar{l}(\bar{l} - 1). \quad [4.116]$$

Comparing Equations 4.113 and 4.116, we see that $l(l + 1) = \bar{l}(\bar{l} - 1)$, so either $\bar{l} = l + 1$ (which is absurd—the bottom rung is higher than the top rung!), or else

$$\bar{l} = -l. \quad [4.117]$$

Evidently the eigenvalues of L_z are $m\hbar$, where m (the appropriateness of this letter will also be clear in a moment) goes from $-l$ to $+l$ in N integer steps. In particular, it follows that $l = -l + N$, and hence $l = N/2$, so l must be *an integer or a half-integer*. The eigenfunctions are characterized by the numbers l and m :

$$L^2 f_l^m = \hbar^2 l(l + 1) f_l^m; \quad L_z f_l^m = \hbar m f_l^m, \quad [4.118]$$

where

$$l = 0, 1/2, 1, 3/2, \dots; \quad m = -l, -l + 1, \dots, l - 1, l. \quad [4.119]$$

For a given value of l , there are $2l + 1$ different values of m (i.e., $2l + 1$ “rungs” on the “ladder”).

I hope you’re impressed: By *purely algebraic means*, starting with the fundamental commutation relations (Equations 4.98 and 4.99), we have determined the eigenvalues of L^2 and L_z —without ever seeing the eigenfunctions themselves! We turn now to the problem of constructing the eigenfunctions, but I should warn you that this is a much messier business. Just so you know where we’re headed, I’ll tell you the punch line before we begin: $f_l^m = Y_l^m$ —the eigenfunctions of L^2 and L_z are nothing but the old spherical harmonics, which we came upon by a quite different route in Section 4.1.2 (that’s why I chose the letters l and m , of course).

Problem 4.18

- (a) Prove that if f is simultaneously an eigenfunction of L^2 and of L_z (Equation 4.104), the square of the eigenvalue of L_z cannot exceed the eigenvalue of L^2 . *Hint:* Examine the expectation value of L^2 .
- (b) As it turns out (see Equations 4.118 and 4.119), the square of the eigenvalue of L_z never even *equals* the eigenvalue of L^2 (except in the special case $l = m = 0$). Comment on the implications of this result. Show that it is enforced by the uncertainty principle (Equation 4.100), and explain how the special case gets away with it.

***Problem 4.19** The raising and lowering operators change the value of m by one unit:

$$L_{\pm} f_l^m = (A_l^m) f_l^{m \pm 1}, \quad [4.120]$$

where A_l^m is some constant. *Question:* What is A_l^m , if the eigenfunctions are to be *normalized*? *Hint:* First show that L_{\mp} is the Hermitian conjugate of L_{\pm} (since L_x

and L_y are observables, you may assume they are Hermitian, but prove it if you like. Then use Equation 4.112. *Answer:*

$$A_l^m = \hbar \sqrt{l(l+1) - m(m \pm 1)}. \quad [4.121]$$

Note what happens at the top and bottom of the ladder.

***Problem 4.20**

- (a) Starting with the canonical commutation relations for position and momentum, Equation 4.10, work out the following commutators:

$$\begin{aligned} [L_z, x] &= i\hbar y, & [L_z, y] &= -i\hbar x, & [L_z, z] &= 0 \\ [L_z, p_x] &= i\hbar p_y, & [L_z, p_y] &= -i\hbar p_x, & [L_z, p_z] &= 0. \end{aligned} \quad [4.122]$$

- (b) Use these results to obtain $[L_z, L_x] = i\hbar L_y$ directly from Equation 4.96.
 (c) Evaluate the commutators $[L_z, r^2]$ and $[L_z, p^2]$ (where, of course, $r^2 = x^2 + y^2 + z^2$ and $p^2 = p_x^2 + p_y^2 + p_z^2$).
 (d) Show that the Hamiltonian $H = (p^2/2m) + V$ commutes with all three components of \mathbf{L} , provided that V depends only on r . (Thus H , L^2 , and L_z are mutually compatible observables.)

****Problem 4.21**

- (a) Prove that for a particle in a potential $V(\mathbf{r})$ the rate of change of the expectation value of the orbital angular momentum \mathbf{L} is equal to the expectation value of the torque:

$$\frac{d}{dt} \langle \mathbf{L} \rangle = \langle \mathbf{N} \rangle,$$

where

$$\mathbf{N} = \mathbf{r} \times (-\nabla V).$$

(This is the rotational analog to Ehrenfest's theorem.)

- (b) Show that $d\langle \mathbf{L} \rangle/dt = 0$ for any spherically symmetric potential. (This is one form of the quantum statement of **conservation of angular momentum**.)

4.3.2 Eigenfunctions

First of all we need to rewrite L_x , L_y , and L_z in spherical coordinates. Now $\mathbf{L} = (\hbar/i)(\mathbf{r} \times \nabla)$, and the gradient, in spherical coordinates, is²⁰

$$\nabla = \hat{r} \frac{\partial}{\partial r} + \hat{\theta} \frac{1}{r} \frac{\partial}{\partial \theta} + \hat{\phi} \frac{1}{r \sin \theta} \frac{\partial}{\partial \phi}; \quad [4.123]$$

²⁰George Arfken, *Mathematical Methods for Physicists*, 3rd ed. (Orlando, FL: Academic Press, 1985), Section 2.5.

meanwhile, $\mathbf{r} = r\hat{r}$, so

$$\mathbf{L} = \frac{\hbar}{i} \left[r(\hat{r} \times \hat{r}) \frac{\partial}{\partial r} + (\hat{r} \times \hat{\theta}) \frac{\partial}{\partial \theta} + (\hat{r} \times \hat{\phi}) \frac{1}{\sin \theta} \frac{\partial}{\partial \phi} \right].$$

But $(\hat{r} \times \hat{r}) = 0$, $(\hat{r} \times \hat{\theta}) = \hat{\phi}$, and $(\hat{r} \times \hat{\phi}) = -\hat{\theta}$ (see Figure 4.1), and hence

$$\mathbf{L} = \frac{\hbar}{i} \left(\hat{\phi} \frac{\partial}{\partial \theta} - \hat{\theta} \frac{1}{\sin \theta} \frac{\partial}{\partial \phi} \right). \quad [4.124]$$

The unit vectors $\hat{\theta}$ and $\hat{\phi}$ can be resolved into their Cartesian components:

$$\hat{\theta} = (\cos \theta \cos \phi)\hat{i} + (\cos \theta \sin \phi)\hat{j} - (\sin \theta)\hat{k}; \quad [4.125]$$

$$\hat{\phi} = -(\sin \phi)\hat{i} + (\cos \phi)\hat{j}. \quad [4.126]$$

Thus

$$\mathbf{L} = \frac{\hbar}{i} \left[(-\sin \phi \hat{i} + \cos \phi \hat{j}) \frac{\partial}{\partial \theta} - (\cos \theta \cos \phi \hat{i} + \cos \theta \sin \phi \hat{j} - \sin \theta \hat{k}) \frac{1}{\sin \theta} \frac{\partial}{\partial \phi} \right].$$

Evidently,

$$L_x = \frac{\hbar}{i} \left(-\sin \phi \frac{\partial}{\partial \theta} - \cos \phi \cot \theta \frac{\partial}{\partial \phi} \right), \quad [4.127]$$

$$L_y = \frac{\hbar}{i} \left(+\cos \phi \frac{\partial}{\partial \theta} - \sin \phi \cot \theta \frac{\partial}{\partial \phi} \right), \quad [4.128]$$

and

$$L_z = \frac{\hbar}{i} \frac{\partial}{\partial \phi}. \quad [4.129]$$

We shall also need the raising and lowering operators:

$$L_{\pm} = L_x \pm iL_y = \frac{\hbar}{i} \left[(-\sin \phi \pm i \cos \phi) \frac{\partial}{\partial \theta} - (\cos \phi \pm i \sin \phi) \cot \theta \frac{\partial}{\partial \phi} \right].$$

But $\cos \phi \pm i \sin \phi = e^{\pm i\phi}$, so

$$L_{\pm} = \pm \hbar e^{\pm i\phi} \left(\frac{\partial}{\partial \theta} \pm i \cot \theta \frac{\partial}{\partial \phi} \right). \quad [4.130]$$

We are now in a position to determine $f_l^m(\theta, \phi)$ (I'll drop the subscript and superscript for now). It's an eigenfunction of L_z , with eigenvalue $\hbar m$:

$$L_z f = \frac{\hbar}{i} \frac{\partial f}{\partial \phi} = \hbar m f,$$

so

$$f = g(\theta) e^{im\phi}. \quad [4.131]$$

[Here $g(\theta)$ is a constant of integration, as far as ϕ is concerned, but it can still depend on θ .] And f is also an eigenfunction of L^2 (which we'll write in terms of L_{\pm} and L_z , using Equation 4.112), with eigenvalue $\hbar^2 l(l+1)$:

$$\begin{aligned} L^2 f &= (L_+ L_- + L_z^2 - \hbar L_z) f \\ &= \hbar e^{i\phi} \left(\frac{\partial}{\partial \theta} + i \cot \theta \frac{\partial}{\partial \phi} \right) (-\hbar e^{-i\phi}) \left(\frac{\partial f}{\partial \theta} - i \cot \theta \frac{\partial f}{\partial \phi} \right) - \hbar^2 \frac{\partial^2 f}{\partial \phi^2} - \frac{\hbar^2}{i} \frac{\partial f}{\partial \phi} \\ &= \hbar^2 l(l+1) f. \end{aligned}$$

But in view of Equation 4.131, $\partial f / \partial \theta = e^{im\phi} dg / d\theta$ and $\partial f / \partial \phi = im e^{im\phi} g$, so

$$\begin{aligned} -e^{i\phi} \left(\frac{\partial}{\partial \theta} + i \cot \theta \frac{\partial}{\partial \phi} \right) (e^{i(m-1)\phi}) \left(\frac{dg}{d\theta} + mg \cot \theta \right) + m^2 g e^{im\phi} - m g e^{im\phi} \\ = e^{im\phi} \left[-\frac{d}{d\theta} \left(\frac{dg}{d\theta} + mg \cot \theta \right) + (m-1) \cot \theta \left(\frac{dg}{d\theta} + mg \cot \theta \right) \right. \\ \left. + m(m-1)g \right] = l(l+1) g e^{im\phi}. \end{aligned}$$

Canceling $e^{im\phi}$,

$$\begin{aligned} -\frac{d^2 g}{d\theta^2} - m \frac{dg}{d\theta} \cot \theta + mg \csc^2 \theta + (m-1) \cot \theta \frac{dg}{d\theta} + m(m-1)(1 + \cot^2 \theta)g \\ = -\frac{d^2 g}{d\theta^2} - \cot \theta \frac{dg}{d\theta} + m^2 g \csc^2 \theta = l(l+1)g, \end{aligned}$$

or, multiplying through by $-\sin^2 \theta$:

$$\sin^2 \theta \frac{d^2 g}{d\theta^2} + \sin \theta \cos \theta \frac{dg}{d\theta} - m^2 g = -l(l+1) \sin^2 \theta g.$$

This is a differential equation for $g(\theta)$; it can be written in a more familiar form:

$$\sin \theta \frac{d}{d\theta} \left(\sin \theta \frac{dg}{d\theta} \right) + [l(l+1) \sin^2 \theta - m^2] g = 0. \quad [4.132]$$

But this is precisely the equation for the θ -dependent part, $\Theta(\theta)$, of $Y_l^m(\theta, \phi)$ (compare Equation 4.25). Meanwhile, the ϕ -dependent part of f (to wit, $e^{im\phi}$) is identical to $\Phi(\phi)$ (Equation 4.22). Conclusion: The *spherical harmonics are precisely the (normalized) eigenfunctions of L^2 and L_z .*

When we solved the Schrödinger equation by separation of variables, in Section 4.1, we were inadvertently constructing simultaneous eigenfunctions of the three commuting operators H , L^2 , and L_z :

$$H\psi = E\psi, \quad L^2\psi = \hbar^2 l(l+1)\psi, \quad L_z\psi = \hbar m\psi. \quad [4.133]$$

But there is a curious twist to this story, for the *algebraic* theory of angular momentum permits l (and hence also m) to take on *half-integer* values (Equation 4.119), whereas the *analytic* method yielded eigenfunctions only for *integer* values (Equation 4.29). You might reasonably guess that the half-integer solutions are spurious, but it turns out that they are of profound importance, as we shall see in the following sections.

***Problem 4.22**

- (a) What is $L_+ Y_l^l$? (No calculation allowed!)
- (b) Use the result of (a), together with the fact that $L_z Y_l^l = \hbar l Y_l^l$, to determine $Y_l^l(\theta, \phi)$, up to a normalization constant.
- (c) Determine the normalization constant by direct integration. Compare your final answer to what you got in Problem 4.5.

Problem 4.23 In Problem 4.3 you showed that

$$Y_2^1(\theta, \phi) = -\sqrt{15/8\pi} \sin\theta \cos\theta e^{i\phi}.$$

Apply the raising operator to find $Y_2^2(\theta, \phi)$. Use Equation 4.121 to get the normalization.

Problem 4.24

- (a) Prove that the spherical harmonics are orthogonal (Equation 4.33). *Hint:* This requires no calculation, if you invoke the appropriate theorem.
- (b) Prove the orthogonality of the hydrogen wave functions $\psi_{nlm}(r, \theta, \phi)$ (Equation 4.90).

Problem 4.25 Two particles of mass m are attached to the ends of a massless rigid rod of length a . The system is free to rotate in three dimensions about the center (but the center point itself is fixed).

- (a) Show that the allowed energies of this **rigid rotor** are

$$E_n = \frac{\hbar^2 n(n+1)}{ma^2}, \quad \text{for } n = 0, 1, 2, \dots$$

Hint: First express the (classical) energy in terms of the total angular momentum.

- (b) What are the normalized eigenfunctions for this system? What is the degeneracy of the n th energy level?

4.4 SPIN

In *classical* mechanics, a rigid object admits two kinds of angular momentum: **orbital** ($\mathbf{L} = \mathbf{r} \times \mathbf{p}$), associated with the motion *of* the center of mass, and **spin** ($\mathbf{S} = I\boldsymbol{\omega}$), associated with motion *about* the center of mass. For example, the earth has orbital angular momentum attributable to its annual revolution around the sun, and spin angular momentum coming from its daily rotation about the north-south axis. In the classical context this distinction is largely a matter of convenience, for when you come right down to it, \mathbf{S} is nothing but the sum total of the “orbital” angular momenta of all the rocks and dirt clods that go to make up the earth, as they circle around the axis. But an analogous thing happens in quantum mechanics, and here the distinction is absolutely fundamental. In addition to orbital angular momentum, associated (in the case of hydrogen) with the motion of the electron around the nucleus (and described by the spherical harmonics), the electron also carries *another* form of angular momentum, which has nothing to do with motion in space (and which is not, therefore, described by any function of the position variables r, θ, ϕ) but which is somewhat analogous to classical spin (and for which, therefore, we use the same word). It doesn't pay to press this analogy too far: The electron (as far as we know) is a structureless point particle, and its spin angular momentum cannot be decomposed into orbital angular momenta of constituent parts (see Problem 4.26).²¹ Suffice it to say that elementary particles carry **intrinsic** angular momentum (\mathbf{S}) in addition to their “extrinsic” angular momentum (\mathbf{L}).

The *algebraic* theory of spin is a carbon copy of the theory of orbital angular momentum, beginning with the fundamental commutation relations²²:

$$[S_x, S_y] = i\hbar S_z, \quad [S_y, S_z] = i\hbar S_x, \quad [S_z, S_x] = i\hbar S_y. \quad [4.134]$$

It follows (as before) that the eigenvectors of S^2 and S_z satisfy²³

$$S^2|s m\rangle = \hbar^2 s(s+1)|s m\rangle; \quad S_z|s m\rangle = \hbar m|s m\rangle; \quad [4.135]$$

and

$$S_{\pm}|s m\rangle = \hbar\sqrt{s(s+1) - m(m \pm 1)}|s(m \pm 1)\rangle, \quad [4.136]$$

²¹For a contrary interpretation, see Hans C. Ohanian, “What is Spin?”, *Am. J. Phys.* **54**, 500 (1986).

²²We shall take these as *postulates* for the theory of spin; the analogous formulas for *orbital* angular momentum (Equations 4.98 and 4.99) were *derived* from the known form of the operators (Equation 4.97). In a more sophisticated treatment they can both be obtained from the rotational invariance of the three-dimensional world [see, for example, Leslie E. Ballentine, *Quantum Mechanics* (Englewood Cliffs, NJ: Prentice Hall, 1990), Section 3.3]. Indeed, these fundamental commutation relations apply to *all* forms of angular momentum, whether spin, orbital, or the combined angular momentum of a composite system, which could include some spin and some orbital.

²³Because the eigenstates of spin are not *functions*, I revert to the “ket” notation for them. (I could have done the same in Section 4.3, writing $|l m\rangle$ in place of Y_l^m , but in that context the function notation seems more natural.) By the way, I'm running out of letters, so I'll use m for the eigenvalue of S_z , just as I did for L_z (some authors write m_l and m_s at this stage, just to be absolutely clear).

where $S_{\pm} \equiv S_x \pm iS_y$. But this time the eigenvectors are *not* spherical harmonics (they're not functions of θ and ϕ at all), and there is no a priori reason to exclude the half-integer values of s and m :

$$s = 0, \frac{1}{2}, 1, \frac{3}{2}, \dots; \quad m = -s, -s + 1, \dots, s - 1, s. \quad [4.137]$$

It so happens that every elementary particle has a *specific and immutable* value of s , which we call the **spin** of that particular species: pi mesons have spin 0; electrons have spin 1/2; photons have spin 1; deltas have spin 3/2; gravitons have spin 2; and so on. By contrast, the *orbital* angular momentum quantum number l (for an electron in a hydrogen atom, say) can take on any (integer) value you please, and will change from one to another when the system is perturbed. But s is *fixed*, for any given particle, and this makes the theory of spin comparatively simple.²⁴

Problem 4.26 If the electron is a classical solid sphere, with radius

$$r_e = \frac{e^2}{4\pi\epsilon_0 mc^2}, \quad [4.138]$$

(the so-called **classical electron radius**, obtained by assuming that the electron's mass is attributable to energy stored in its electric field, via the Einstein formula $E = mc^2$), and its angular momentum is $(1/2)\hbar$, then how fast (in m/s) is a point on the "equator" moving? Does this model for spin make sense? (Actually, the radius of the electron is known experimentally to be much less than r_e , but this only makes matters worse.)

4.4.1 Spin 1/2

By far the most important case is $s = 1/2$, for this is the spin of the particles that make up ordinary matter (protons, neutrons, and electrons), as well as all quarks and all leptons. Moreover, once you understand spin 1/2, it is a simple matter to work out the formalism for any higher spin. There are just *two* eigenstates: $|\frac{1}{2} \frac{1}{2}\rangle$, which we call **spin up** (informally, \uparrow), and $|\frac{1}{2} (-\frac{1}{2})\rangle$, which we call **spin down** (\downarrow). Using these as basis vectors, the general state of a spin-1/2 particle can be expressed as a two-element column matrix (or **spinor**):

$$\chi = \begin{pmatrix} a \\ b \end{pmatrix} = a\chi_+ + b\chi_-. \quad [4.139]$$

²⁴Indeed, in a mathematical sense, spin 1/2 is the simplest possible nontrivial quantum system, for it admits just two possible states. In place of an infinite-dimensional Hilbert space, with all its subtleties and complications, we find ourselves working in an ordinary two-dimensional vector space; in place of unfamiliar differential equations and fancy functions, we are confronted with 2×2 matrices and two-component vectors. For this reason, some authors *begin* quantum mechanics with a treatment of the spin-1/2 system. But the price of mathematical simplicity is conceptual abstraction, and I prefer not to do it that way.

with

$$\chi_+ = \begin{pmatrix} 1 \\ 0 \end{pmatrix} \quad [4.140]$$

representing spin up, and

$$\chi_- = \begin{pmatrix} 0 \\ 1 \end{pmatrix} \quad [4.141]$$

for spin down. Meanwhile, the spin operators become 2×2 matrices, which we can work out by noting their effect on χ_+ and χ_- : Equation 4.135 says

$$S^2 \chi_+ = \frac{3}{4} \hbar^2 \chi_+; \quad S^2 \chi_- = \frac{3}{4} \hbar^2 \chi_-; \quad S_z \chi_+ = \frac{\hbar}{2} \chi_+; \quad S_z \chi_- = -\frac{\hbar}{2} \chi_-; \quad [4.142]$$

and Equation 4.136 gives

$$S_+ \chi_- = \hbar \chi_+; \quad S_- \chi_+ = \hbar \chi_-; \quad S_+ \chi_+ = S_- \chi_- = 0. \quad [4.143]$$

Now, $S_{\pm} = S_x \pm i S_y$, so

$$S_x = \frac{1}{2}(S_+ + S_-) \quad \text{and} \quad S_y = \frac{1}{2i}(S_+ - S_-), \quad [4.144]$$

and it follows that

$$S_x \chi_+ = \frac{\hbar}{2} \chi_-; \quad S_x \chi_- = \frac{\hbar}{2} \chi_+; \quad S_y \chi_+ = -\frac{\hbar}{2i} \chi_-; \quad S_y \chi_- = \frac{\hbar}{2i} \chi_+. \quad [4.145]$$

Thus

$$S^2 = \frac{3}{4} \hbar^2 \begin{pmatrix} 1 & 0 \\ 0 & 1 \end{pmatrix}; \quad S_+ = \hbar \begin{pmatrix} 0 & 1 \\ 0 & 0 \end{pmatrix}; \quad S_- = \hbar \begin{pmatrix} 0 & 0 \\ 1 & 0 \end{pmatrix}; \quad [4.146]$$

while

$$S_x = \frac{\hbar}{2} \begin{pmatrix} 0 & 1 \\ 1 & 0 \end{pmatrix}; \quad S_y = \frac{\hbar}{2} \begin{pmatrix} 0 & -i \\ i & 0 \end{pmatrix}; \quad S_z = \frac{\hbar}{2} \begin{pmatrix} 1 & 0 \\ 0 & -1 \end{pmatrix}. \quad [4.147]$$

It's a little tidier to divide off the factor of $\hbar/2$: $\mathbf{S} = (\hbar/2)\boldsymbol{\sigma}$, where

$$\sigma_x \equiv \begin{pmatrix} 0 & 1 \\ 1 & 0 \end{pmatrix}; \quad \sigma_y \equiv \begin{pmatrix} 0 & -i \\ i & 0 \end{pmatrix}; \quad \sigma_z \equiv \begin{pmatrix} 1 & 0 \\ 0 & -1 \end{pmatrix}. \quad [4.148]$$

These are the famous **Pauli spin matrices**. Notice that S_x , S_y , S_z , and S^2 are all *Hermitian* (as they should be, since they represent observables). On the other hand, S_+ and S_- are *not* Hermitian—evidently they are not observable.

The eigenspinors of S_z are (of course)

$$\chi_+ = \begin{pmatrix} 1 \\ 0 \end{pmatrix}, \quad (\text{eigenvalue } +\frac{\hbar}{2}); \quad \chi_- = \begin{pmatrix} 0 \\ 1 \end{pmatrix}, \quad (\text{eigenvalue } -\frac{\hbar}{2}). \quad [4.149]$$

If you measure S_z on a particle in the general state χ (Equation 4.139), you could get $+\hbar/2$, with probability $|a|^2$, or $-\hbar/2$, with probability $|b|^2$. Since these are the *only* possibilities,

$$|a|^2 + |b|^2 = 1 \quad [4.150]$$

(i.e., the spinor must be normalized).²⁵

But what if, instead, you chose to measure S_x ? What are the possible results, and what are their respective probabilities? According to the generalized statistical interpretation, we need to know the eigenvalues and eigenspinors of S_x . The characteristic equation is

$$\begin{vmatrix} -\lambda & \hbar/2 \\ \hbar/2 & -\lambda \end{vmatrix} = 0 \Rightarrow \lambda^2 = \left(\frac{\hbar}{2}\right)^2 \Rightarrow \lambda = \pm \frac{\hbar}{2}.$$

Not surprisingly, the possible values for S_x are the same as those for S_z . The eigenspinors are obtained in the usual way:

$$\frac{\hbar}{2} \begin{pmatrix} 0 & 1 \\ 1 & 0 \end{pmatrix} \begin{pmatrix} \alpha \\ \beta \end{pmatrix} = \pm \frac{\hbar}{2} \begin{pmatrix} \alpha \\ \beta \end{pmatrix} \Rightarrow \begin{pmatrix} \beta \\ \alpha \end{pmatrix} = \pm \begin{pmatrix} \alpha \\ \beta \end{pmatrix},$$

so $\beta = \pm\alpha$. Evidently the (normalized) eigenspinors of S_x are

$$\chi_+^{(x)} = \begin{pmatrix} \frac{1}{\sqrt{2}} \\ \frac{1}{\sqrt{2}} \end{pmatrix}, \text{ (eigenvalue } +\frac{\hbar}{2}\text{); } \chi_-^{(x)} = \begin{pmatrix} \frac{1}{\sqrt{2}} \\ -\frac{1}{\sqrt{2}} \end{pmatrix}, \text{ (eigenvalue } -\frac{\hbar}{2}\text{)}. \quad [4.151]$$

As the eigenvectors of a Hermitian matrix, they span the space; the generic spinor χ can be expressed as a linear combination of them:

$$\chi = \left(\frac{a+b}{\sqrt{2}}\right) \chi_+^{(x)} + \left(\frac{a-b}{\sqrt{2}}\right) \chi_-^{(x)}. \quad [4.152]$$

If you measure S_x , the probability of getting $+\hbar/2$ is $(1/2)|a+b|^2$, and the probability of getting $-\hbar/2$ is $(1/2)|a-b|^2$. (You should check for yourself that these probabilities add up to 1.)

Example. Suppose a spin 1/2 particle is in the state

$$\chi = \frac{1}{\sqrt{6}} \begin{pmatrix} 1+i \\ 2 \end{pmatrix}.$$

If you measure S_z , the probability of getting $+\hbar/2$ is $|(1+i)/\sqrt{6}|^2 = 1/3$, and the probability of getting $-\hbar/2$ is $|2/\sqrt{6}|^2 = 2/3$. If you measure S_x , the probability of

²⁵People often say that $|a|^2$ is the “probability that the particle is in the spin-up state”, but this is sloppy language; the particle is in state χ —*not* χ_+ —and what the speaker really *means* is that if you measured S_z , $|a|^2$ is the probability you’d get $\hbar/2$, which is an entirely different assertion.

getting $+\hbar/2$ is $(1/2)|(3+i)/\sqrt{6}|^2 = 5/6$, and the probability of getting $-\hbar/2$ is $(1/2)|(-1+i)/\sqrt{6}|^2 = 1/6$. Evidently the *expectation* value of S_x is

$$\frac{5}{6} \left(+\frac{\hbar}{2} \right) + \frac{1}{6} \left(-\frac{\hbar}{2} \right) = \frac{\hbar}{3},$$

which we could also have obtained more directly:

$$\langle S_x \rangle = \chi^\dagger S_x \chi = \begin{pmatrix} \frac{1-i}{\sqrt{6}} & \frac{2}{\sqrt{6}} \end{pmatrix} \begin{pmatrix} 0 & \hbar/2 \\ \hbar/2 & 0 \end{pmatrix} \begin{pmatrix} (1+i)/\sqrt{6} \\ 2/\sqrt{6} \end{pmatrix} = \frac{\hbar}{3}.$$

I'd like now to walk you through an imaginary measurement scenario involving spin 1/2, because it serves to illustrate in very concrete terms some of the abstract ideas we discussed back in Chapter 1. Let's say we start out with a particle in the state χ_+ . If someone asks, "What is the z-component of that particle's spin angular momentum?", we could answer unambiguously: $+\hbar/2$. For a measurement of S_z is certain to return that value. But if our interrogator asks instead, "What is the x-component of that particle's spin angular momentum?", we are obliged to equivocate: If you measure S_x , the chances are 50-50 of getting either $\hbar/2$ or $-\hbar/2$. If the questioner is a classical physicist, or a "realist" (in the sense of Section 1.2), he will regard this as an inadequate—not to say impertinent—response: "Are you telling me that you *don't know* the true state of that particle?" On the contrary; I know *precisely* what the state of the particle is: χ_+ . "Well, then, how come you can't tell me what the x-component of its spin is?" Because it simply *does not have* a particular x-component of spin. Indeed, it *cannot*, for if both S_x and S_z were well defined, the uncertainty principle would be violated.

At this point our challenger grabs the test tube and *measures* the x-component of its spin; let's say he gets the value $+\hbar/2$. "Aha!" (he shouts in triumph), "You *lied!* This particle has a perfectly well-defined value of S_x : It's $\hbar/2$." Well, sure—it does *now*, but that doesn't prove it *had* that value, prior to your measurement. "You have obviously been reduced to splitting hairs. And anyway, what happened to your uncertainty principle? I now know both S_x and S_z ." I'm sorry, but you do *not*: In the course of your measurement, you altered the particle's state; it is now in the state $\chi_+^{(x)}$, and whereas you know the value of S_x , you no longer know the value of S_z . "But I was extremely careful not to disturb the particle when I measured S_x ."²⁶ Very well, if you don't believe me, *check it out*: Measure S_z , and see what you get. (Of course, he *may* get $+\hbar/2$, which will be embarrassing to my case—but if we repeat this whole scenario over and over, half the time he will get $-\hbar/2$.)

To the layperson, the philosopher, or the classical physicist, a statement of the form "this particle doesn't have a well-defined position" (or momentum, or

²⁶Neils Bohr was anxious to track down the *mechanism* by which the measurement of S_x inevitably destroys the value of S_z , in gedanken experiments of this sort. His famous debates with Einstein include many delightful examples, showing in detail how experimental constraints serve to enforce the uncertainty principle.

x -component of spin angular momentum, or whatever) sounds vague, incompetent, or (worst of all) profound. It is none of these. But its precise meaning is, I think, almost impossible to convey to anyone who has not studied quantum mechanics in some depth. If you find your own comprehension slipping, from time to time (if you *don't*, you probably haven't understood the problem), come back to the spin-1/2 system: It is the simplest and cleanest context for thinking through the conceptual paradoxes of quantum mechanics.

Problem 4.27

- (a) Check that the spin matrices (Equation 4.147) obey the fundamental commutation relation for angular momentum: $[S_x, S_y] = i\hbar S_z$.
- (b) Show that the Pauli spin matrices satisfy

$$\sigma_j \sigma_k = \delta_{jk} + i \sum_l \epsilon_{jkl} \sigma_l, \quad [4.153]$$

where the indices stand for x , y , or z , and ϵ_{jkl} is the **Levi-Civita** symbol: +1 if $jkl = 123, 231$, or 312 ; -1 if $jkl = 132, 213$, or 321 ; 0 otherwise.

***Problem 4.28** An electron is in the spin state

$$\chi = A \begin{pmatrix} 3i \\ 4 \end{pmatrix}.$$

- (a) Determine the normalization constant A .
- (b) Find the expectation values of S_x , S_y , and S_z .
- (c) Find the "uncertainties" σ_{S_x} , σ_{S_y} , and σ_{S_z} .
- (d) Confirm that your results are consistent with all three uncertainty principles (Equation 4.100 and its cyclic permutations—only with S in place of L , of course).

***Problem 4.29** For the most general normalized spinor χ (Equation 4.139), compute $\langle S_x \rangle$, $\langle S_y \rangle$, $\langle S_z \rangle$, $\langle S_x^2 \rangle$, $\langle S_y^2 \rangle$, and $\langle S_z^2 \rangle$. Check that $\langle S_x^2 \rangle + \langle S_y^2 \rangle + \langle S_z^2 \rangle = \langle S^2 \rangle$.

***Problem 4.30**

- (a) Find the eigenvalues and eigenspinors of S_y .
- (b) If you measured S_y on a particle in the general state χ (Equation 4.139), what values might you get, and what is the probability of each? Check that the probabilities add up to 1.
- (c) If you measured S_y^2 , what values might you get and with what probability?
-

****Problem 4.31** Construct the matrix S_r representing the component of spin angular momentum along an arbitrary direction \hat{r} . Use spherical coordinates, so that

$$\hat{r} = \sin \theta \cos \phi \hat{i} + \sin \theta \sin \phi \hat{j} + \cos \theta \hat{k}. \quad [4.154]$$

Find the eigenvalues and (normalized) eigenspinors of S_r . *Answer:*

$$\chi_+^{(r)} = \begin{pmatrix} \cos(\theta/2) \\ e^{i\phi} \sin(\theta/2) \end{pmatrix}; \quad \chi_-^{(r)} = \begin{pmatrix} \sin(\theta/2) \\ -e^{i\phi} \cos(\theta/2) \end{pmatrix}. \quad [4.155]$$

Problem 4.32 Construct the spin matrices (S_x , S_y , and S_z) for a particle of spin 1. *Hint:* How many eigenstates of S_z are there? Determine the action of S_z , S_+ , and S_- on each of these states. Follow the procedure used in the text for spin 1/2.

4.4.2 Electron in a Magnetic Field

A spinning charged particle constitutes a magnetic dipole. Its **magnetic dipole moment** $\boldsymbol{\mu}$ is proportional to its spin angular momentum \mathbf{S} :

$$\boldsymbol{\mu} = \gamma \mathbf{S}; \quad [4.156]$$

the proportionality constant γ is called the **gyromagnetic ratio**.²⁷ When a magnetic dipole is placed in a magnetic field \mathbf{B} , it experiences a torque, $\boldsymbol{\mu} \times \mathbf{B}$, which tends to line it up parallel to the field (just like a compass needle). The energy associated with this torque is²⁸

$$H = -\boldsymbol{\mu} \cdot \mathbf{B}, \quad [4.157]$$

so the Hamiltonian of a spinning charged particle, at rest²⁹ in a magnetic field \mathbf{B} , becomes

$$H = -\gamma \mathbf{B} \cdot \mathbf{S}, \quad [4.158]$$

where \mathbf{S} is the appropriate spin matrix (Equation 4.147, in the case of spin 1/2).

Example: Larmor precession. Imagine a particle of spin 1/2 at rest in a uniform magnetic field, which points in the z -direction:

$$\mathbf{B} = B_0 \hat{k}. \quad [4.159]$$

²⁷See, for example, D. Griffiths, *Introduction to Electrodynamics*, 2nd ed. (Englewood Cliffs, NJ: Prentice Hall, 1986), page 239. Classically, the gyromagnetic ratio of a rigid object is $q/2m$, where q is its charge and m is its mass. For reasons that are fully explained only in relativistic quantum theory, the gyromagnetic ratio of the electron is almost exactly *twice* the classical value.

²⁸Griffiths, (footnote 27), pages 246 and 268.

²⁹If the particle is allowed to *move*, there will also be kinetic energy to consider; moreover, it will be subject to the Lorentz force ($q\mathbf{v} \times \mathbf{B}$), which is not derivable from a potential energy function and hence does not fit the Schrödinger equation as we have formulated it so far. I'll show you later on how to handle this problem, but for the moment let's just assume that the particle is free to *rotate*, but otherwise stationary.

The Hamiltonian matrix is

$$H = -\gamma B_0 S_z = -\frac{\gamma B_0 \hbar}{2} \begin{pmatrix} 1 & 0 \\ 0 & -1 \end{pmatrix}. \quad [4.160]$$

The eigenstates of H are the same as those of S_z :

$$\begin{cases} \chi_+, & \text{with energy } E_+ = -(\gamma B_0 \hbar)/2, \\ \chi_-, & \text{with energy } E_- = +(\gamma B_0 \hbar)/2. \end{cases} \quad [4.161]$$

Evidently, the energy is lowest when the dipole moment is parallel to the field—just as it would be classically.

Since the Hamiltonian is time independent, the general solution to the time-dependent Schrödinger equation,

$$i\hbar \frac{\partial \chi}{\partial t} = H\chi, \quad [4.162]$$

can be expressed in terms of the stationary states:

$$\chi(t) = a\chi_+ e^{-iE_+ t/\hbar} + b\chi_- e^{-iE_- t/\hbar} = \begin{pmatrix} a e^{i\gamma B_0 t/2} \\ b e^{-i\gamma B_0 t/2} \end{pmatrix}.$$

The constants a and b are determined by the initial conditions; say

$$\chi(0) = \begin{pmatrix} a \\ b \end{pmatrix},$$

where $|a|^2 + |b|^2 = 1$. With no essential loss of generality³⁰ I'll write $a = \cos(\alpha/2)$ and $b = \sin(\alpha/2)$, where α is a fixed angle whose physical significance will appear in a moment. Thus

$$\chi(t) = \begin{pmatrix} \cos(\alpha/2) e^{i\gamma B_0 t/2} \\ \sin(\alpha/2) e^{-i\gamma B_0 t/2} \end{pmatrix}. \quad [4.163]$$

To get a feel for what is happening here, let's calculate the expectation value of the spin $\langle \mathbf{S} \rangle$ as a function of time:

$$\begin{aligned} \langle S_x \rangle &= \chi(t)^\dagger S_x \chi(t) \\ &= (\cos(\alpha/2) e^{-i\gamma B_0 t/2} \quad \sin(\alpha/2) e^{i\gamma B_0 t/2}) \frac{\hbar}{2} \begin{pmatrix} 0 & 1 \\ 1 & 0 \end{pmatrix} \begin{pmatrix} \cos(\alpha/2) e^{i\gamma B_0 t/2} \\ \sin(\alpha/2) e^{-i\gamma B_0 t/2} \end{pmatrix} \\ &= \frac{\hbar}{2} \sin \alpha \cos(\gamma B_0 t). \end{aligned} \quad [4.164]$$

Similarly,

$$\langle S_y \rangle = \chi(t)^\dagger S_y \chi(t) = -\frac{\hbar}{2} \sin \alpha \sin(\gamma B_0 t), \quad [4.165]$$

³⁰This does assume that a and b are *real*; you can work out the general case if you like, but all it does is add a constant to t .

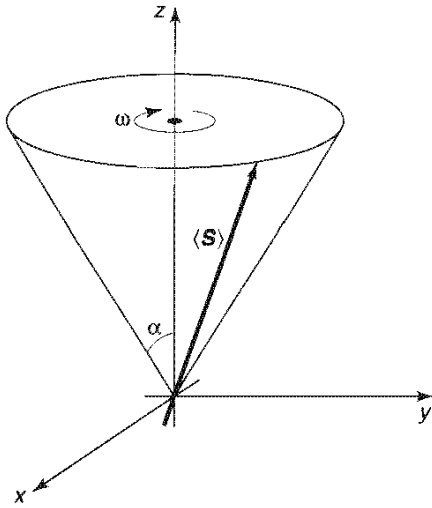

Figure 4.7: Precession of $\langle \mathbf{S} \rangle$ in a uniform magnetic field.

and

$$\langle S_z \rangle = \chi(t)^\dagger S_z \chi(t) = \frac{\hbar}{2} \cos \alpha. \quad [4.166]$$

Evidently $\langle \mathbf{S} \rangle$ is tilted at a constant angle α to the z -axis, and precesses about the field at the **Larmor frequency**

$$\omega = \gamma B_0, \quad [4.167]$$

just as it would classically³¹ (see Figure 4.7). No *surprise* here—Ehrenfest's theorem (in the form derived in Problem 4.21) guarantees that $\langle \mathbf{S} \rangle$ evolves according to the classical laws. But it's nice to see how this works out in a specific context.

Example: the Stern-Gerlach experiment. In an *inhomogeneous* magnetic field, there is not only a torque, but also a force, on a magnetic dipole³²:

$$\mathbf{F} = \nabla(\boldsymbol{\mu} \cdot \mathbf{B}). \quad [4.168]$$

This force can be used to separate out particles with a particular spin orientation, as follows. Imagine a beam of relatively heavy neutral atoms,³³ traveling in the y -direction, which passes through a region of inhomogeneous magnetic field (Figure 4.8)—for example,

$$\mathbf{B}(x, y, z) = -\alpha x \hat{i} + (B_0 + \alpha z) \hat{k}, \quad [4.169]$$

where B_0 is a strong uniform field and the constant α describes a small deviation from homogeneity. (Actually, what we'd *like* is just the z -component of this field, but

³¹See, for instance, *The Feynman Lectures on Physics* (Reading, MA: Addison-Wesley, 1964). Volume II, Section 34-3. Of course, in the classical case it is the angular momentum vector itself, not just its expectation value, that precesses around the magnetic field.

³²Griffiths, (footnote 27), page 247. Note that \mathbf{F} is the negative gradient of the energy (Equation 4.157).

³³We make them neutral to avoid the large-scale deflection that would otherwise result from the Lorentz force, and heavy so we can construct localized wave packets and treat the motion in terms of classical particle trajectories. In practice, the Stern-Gerlach experiment doesn't work, for example, with a beam of free electrons.

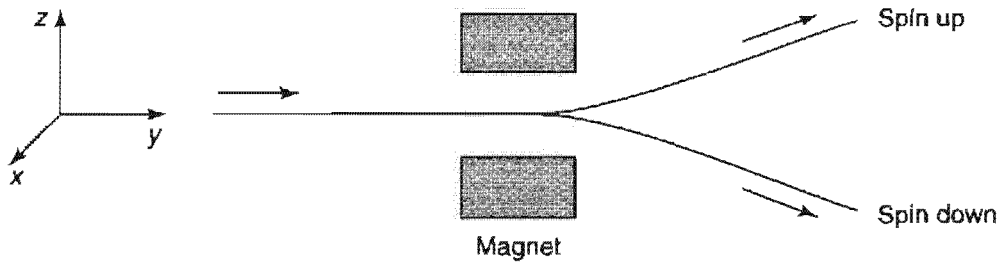

Figure 4.8: The Stern-Gerlach apparatus.

unfortunately that's impossible—it would violate the electromagnetic law $\nabla \cdot \mathbf{B} = 0$; like it or not, the x -component comes along for the ride.) The force on these atoms is

$$\mathbf{F} = \gamma\alpha(-S_x\hat{i} + S_z\hat{k}).$$

But because of the Larmor precession about B_0 , S_x oscillates rapidly, and averages to zero; the *net* force is in the z -direction:

$$F_z = \gamma\alpha S_z, \quad [4.170]$$

and the beam is deflected up or down, in proportion to the z -component of the spin angular momentum. Classically we'd expect a smear, but in fact the beam splits into $2s + 1$ individual beams, beautifully demonstrating the quantization of S_z . (If you use silver atoms, for example, all the inner electrons are paired in such a way that their spin and orbital angular momenta cancel. The net spin is simply that of the outermost—unpaired—electron, so in this case $s = 1/2$, and the beam splits in two.)

That argument was purely *classical*, up to the final step; “force” has no place in a proper quantum calculation, and you might therefore prefer the following approach to the same problem.³⁴ We examine the process from the perspective of a reference frame that moves along with the beam. In this frame the Hamiltonian starts out zero, turns on for a time T (as the particle passes through the magnet), and then turns off again:

$$H(t) = \begin{cases} 0, & \text{for } t < 0, \\ -\gamma(B_0 + \alpha z)S_z, & \text{for } 0 \leq t \leq T, \\ 0, & \text{for } t > T. \end{cases} \quad [4.171]$$

(I ignore the pesky x -component of \mathbf{B} , which—for reasons indicated above—is irrelevant to the problem.) Suppose the atom has spin $1/2$, and starts out in the state

$$\chi(t) = a\chi_+ + b\chi_-, \quad \text{for } t \leq 0.$$

While the Hamiltonian acts, $\chi(t)$ evolves in the usual way:

$$\chi(t) = a\chi_+e^{-iE_+t/\hbar} + b\chi_-e^{-iE_-t/\hbar}, \quad \text{for } 0 \leq t \leq T,$$

³⁴This argument follows L. Ballentine, *Quantum Mechanics* (Englewood Cliffs, NJ: Prentice Hall, 1990), page 172.

where (from Equation 4.158)

$$E_{\pm} = \mp \gamma (B_0 + \alpha z) \frac{\hbar}{2}, \quad [4.172]$$

and hence it emerges in the state

$$\chi(t) = (a e^{i\gamma T B_0/2} \chi_+) e^{i(\alpha\gamma T/2)z} + (b e^{-i\gamma T B_0/2} \chi_-) e^{-i(\alpha\gamma T/2)z}, \quad (t \geq T). \quad [4.173]$$

The two terms now carry *momentum* in the z -direction (see Equation 3.131); the spin-up component has momentum

$$p_z = \frac{\alpha\gamma T \hbar}{2}, \quad [4.174]$$

and it moves in the plus- z direction; the spin-down component has the opposite momentum, and it moves in the minus- z direction. Thus the beam splits in two, as before. (Note that Equation 4.174 is consistent with the earlier result, Equation 4.170, for in this case $S_z = \hbar/2$ and $p_z = F_z T$.)

The Stern-Gerlach experiment has played an important role in the philosophy of quantum mechanics, where it serves both as the prototype for the preparation of a quantum state and as an illuminating model for a certain kind of quantum measurement. We casually assume that the initial state of a system is *known* (the Schrödinger equation tells us how it subsequently evolves)—but it is natural to wonder how you get a system into a particular state in the first place. Well, if you want to prepare a beam of atoms in a given spin configuration, you pass an unpolarized beam through a Stern-Gerlach magnet and select the outgoing stream you are interested in (closing off the others with suitable baffles and shutters). Conversely, if you want to *measure* the z -component of an atom's spin, you send it through a Stern-Gerlach apparatus and record which bin it lands in. I do not claim that this is always the most *practical* way to do the job, but it is *conceptually* very clean and hence a useful context in which to explore the problems of state preparation and measurement.

Problem 4.33 In the first example (Larmor precession in a uniform magnetic field):

- (a) If you measured the component of spin angular momentum along the x -direction, at time t , what is the probability that you would get $+\hbar/2$?
- (b) Same question, but for the y -component.
- (c) Same, but for the z -component.

****Problem 4.34** An electron is at rest in an oscillating magnetic field

$$\mathbf{B} = B_0 \cos(\omega t) \hat{k},$$

where B_0 and ω are constants.

- (a) Construct the Hamiltonian matrix for this system.
- (b) The electron starts out (at $t = 0$) in the spin-up state with respect to the x -axis [that is, $\chi(0) = \chi_+^{(x)}$]. Determine $\chi(t)$ at any subsequent time. *Beware:* This is a *time-dependent* Hamiltonian, so you cannot get $\chi(t)$ in the usual way from stationary states. Fortunately, in this case you can solve the time-dependent Schrödinger equation (Equation 4.162) directly.
- (c) Find the probability of getting $-\hbar/2$ if you measure S_x . *Answer:*

$$\sin^2 \left(\frac{\gamma B_0}{2\omega} \sin(\omega t) \right).$$

- (d) What is the minimum field (B_0) required to force a complete flip in S_x ?

4.4.3 Addition of Angular Momenta

Suppose now that we have *two* spin-1/2 particles—for example, the electron and the proton in the ground state³⁵ of hydrogen. Each can have spin up or spin down, so there are four possibilities in all³⁶:

$$\uparrow\uparrow, \uparrow\downarrow, \downarrow\uparrow, \downarrow\downarrow, \tag{4.175}$$

where the first arrow refers to the electron and the second to the proton. *Question:* What is the *total* angular momentum of the atom? Let

$$\mathbf{S} \equiv \mathbf{S}^{(1)} + \mathbf{S}^{(2)}. \tag{4.176}$$

Each of the four composite states is an eigenstate of S_z —the z -components simply *add*

$$\begin{aligned} S_z \chi_1 \chi_2 &= (S_z^{(1)} + S_z^{(2)}) \chi_1 \chi_2 = (S_z^{(1)} \chi_1) \chi_2 + \chi_1 (S_z^{(2)} \chi_2) \\ &= (\hbar m_1 \chi_1) \chi_2 + \chi_1 (\hbar m_2 \chi_2) = \hbar (m_1 + m_2) \chi_1 \chi_2, \end{aligned}$$

[note that $\mathbf{S}^{(1)}$ acts only on χ_1 , and $\mathbf{S}^{(2)}$ acts only on χ_2]. So m (the quantum number for the composite system) is just $m_1 + m_2$:

$$\begin{aligned} \uparrow\uparrow: m &= 1; \\ \uparrow\downarrow: m &= 0; \\ \downarrow\uparrow: m &= 0; \\ \downarrow\downarrow: m &= -1. \end{aligned}$$

³⁵I put them in the ground state so there won't be any *orbital* angular momentum to worry about.

³⁶More precisely, each particle is in a *linear combination* of spin up and spin down, and the composite system is in a *linear combination* of the four states listed.

At first glance, this doesn't look right: m is supposed to advance in integer steps, from $-s$ to $+s$, so it appears that $s = 1$ —but there is an extra state with $m = 0$. One way to untangle this problem is to apply the lowering operator $S_- = S_-^{(1)} + S_-^{(2)}$ to the state $\uparrow\uparrow$, using Equation 4.143:

$$\begin{aligned} S_-(\uparrow\uparrow) &= (S_-^{(1)} \uparrow) \uparrow + \uparrow (S_-^{(2)} \uparrow) \\ &= (\hbar \downarrow) \uparrow + \uparrow (\hbar \downarrow) = \hbar(\downarrow\uparrow + \uparrow\downarrow). \end{aligned}$$

Evidently the three states with $s = 1$ are (in the notation $|s m\rangle$):

$$\left\{ \begin{array}{l} |1 1\rangle = \uparrow\uparrow \\ |1 0\rangle = \frac{1}{\sqrt{2}}(\uparrow\downarrow + \downarrow\uparrow) \\ |1 -1\rangle = \downarrow\downarrow \end{array} \right\} \quad s = 1 \text{ (triplet)}. \quad [4.177]$$

(As a check, try applying the lowering operator to $|1 0\rangle$; what *should* you get? See Problem 4.35.) This is called the **triplet** combination, for the obvious reason. Meanwhile, the orthogonal state with $m = 0$ carries $s = 0$:

$$\left\{ |0 0\rangle = \frac{1}{\sqrt{2}}(\uparrow\downarrow - \downarrow\uparrow) \right\} \quad s = 0 \text{ (singlet)}. \quad [4.178]$$

(If you apply the raising or lowering operator to this state, you'll get zero. See Problem 4.35.)

I claim, then, that the combination of two spin-1/2 particles can carry a total spin of 1 or 0, depending on whether they occupy the triplet or the singlet configuration. To confirm this, I need to prove that the triplet states are eigenvectors of S^2 with eigenvalue $2\hbar^2$ and the singlet is an eigenvector of S^2 with eigenvalue 0. Now

$$S^2 = (\mathbf{S}^{(1)} + \mathbf{S}^{(2)}) \cdot (\mathbf{S}^{(1)} + \mathbf{S}^{(2)}) = (S^{(1)})^2 + (S^{(2)})^2 + 2\mathbf{S}^{(1)} \cdot \mathbf{S}^{(2)}. \quad [4.179]$$

Using Equations 4.142 and 4.145, we have

$$\begin{aligned} \mathbf{S}^{(1)} \cdot \mathbf{S}^{(2)}(\uparrow\downarrow) &= (S_x^{(1)} \uparrow)(S_x^{(2)} \downarrow) + (S_y^{(1)} \uparrow)(S_y^{(2)} \downarrow) + (S_z^{(1)} \uparrow)(S_z^{(2)} \downarrow) \\ &= \left(\frac{\hbar}{2} \downarrow\right) \left(\frac{\hbar}{2} \uparrow\right) + \left(\frac{i\hbar}{2} \downarrow\right) \left(\frac{-i\hbar}{2} \uparrow\right) + \left(\frac{\hbar}{2} \uparrow\right) \left(\frac{-\hbar}{2} \downarrow\right) \\ &= \frac{\hbar^2}{4}(2 \downarrow\uparrow - \uparrow\downarrow). \end{aligned}$$

Similarly,

$$\mathbf{S}^{(1)} \cdot \mathbf{S}^{(2)}(\downarrow\uparrow) = \frac{\hbar^2}{4}(2 \uparrow\downarrow - \downarrow\uparrow).$$

It follows that

$$\mathbf{S}^{(1)} \cdot \mathbf{S}^{(2)}|1 0\rangle = \frac{\hbar^2}{4} \frac{1}{\sqrt{2}}(2 \downarrow\uparrow - \uparrow\downarrow + 2 \uparrow\downarrow - \downarrow\uparrow) = \frac{\hbar^2}{4}|1 0\rangle, \quad [4.180]$$

and

$$\mathbf{S}^{(1)} \cdot \mathbf{S}^{(2)}|00\rangle = \frac{\hbar^2}{4} \frac{1}{\sqrt{2}}(2 \downarrow\uparrow - \uparrow\downarrow - 2 \uparrow\downarrow + \downarrow\uparrow) = -\frac{3\hbar^2}{4}|00\rangle. \quad [4.181]$$

Returning to Equation 4.179 (and again using Equation 4.142), we conclude that

$$S^2|10\rangle = \left(\frac{3\hbar^2}{4} + \frac{3\hbar^2}{4} + 2\frac{\hbar^2}{4} \right) |10\rangle = 2\hbar^2|10\rangle, \quad [4.182]$$

so $|10\rangle$ is indeed an eigenstate of S^2 with eigenvalue $2\hbar^2$; and

$$S^2|00\rangle = \left(\frac{3\hbar^2}{4} + \frac{3\hbar^2}{4} - 2\frac{3\hbar^2}{4} \right) |00\rangle = 0, \quad [4.183]$$

so $|00\rangle$ is an eigenstate of S^2 with eigenvalue 0. (I will leave it for you to confirm that $|11\rangle$ and $|1-1\rangle$ are eigenstates of S^2 , with the appropriate eigenvalue—see Problem 4.35.)

What we have just done (combining spin 1/2 with spin 1/2 to get spin 1 and spin 0) is the simplest example of a larger problem: If you combine spin s_1 with spin s_2 , what total spins s can you get?³⁷ The answer³⁸ is that you get every spin from $(s_1 + s_2)$ down to $(s_1 - s_2)$ —or $(s_2 - s_1)$, if $s_2 > s_1$ —in integer steps:

$$s = (s_1 + s_2), (s_1 + s_2 - 1), (s_1 + s_2 - 2), \dots, |s_1 - s_2|. \quad [4.184]$$

(Roughly speaking, the highest total spin occurs when the individual spins are aligned parallel to one another, and the lowest occurs when they are antiparallel.) For example, if you package together a particle of spin 3/2 with a particle of spin 2, you could get a total spin of 7/2, 5/2, 3/2, or 1/2, depending on the configuration. Another example: If a hydrogen atom is in the state ψ_{nlm} , the net angular momentum of the electron (spin plus orbital) is $l + 1/2$ or $l - 1/2$; if you now throw in the spin of the proton, the atom's total angular momentum quantum number is $l + 1$, l , or $l - 1$ (and l can be achieved in two distinct ways, depending on whether the electron alone is in the $l + 1/2$ configuration or the $l - 1/2$ configuration).

The particular state $|s m\rangle$ with total spin s and z-component m will be some linear combination of the composite states $|s_1 m_1\rangle|s_2 m_2\rangle$:

$$|s m\rangle = \sum_{m_1+m_2=m} C_{m_1 m_2 m}^{s_1 s_2 s} |s_1 m_1\rangle|s_2 m_2\rangle \quad [4.185]$$

(because the z-components add, the only composite states that contribute are those for which $m_1 + m_2 = m$). Equations 4.177 and 4.178 are special cases of this general

³⁷I say *spins* for simplicity, but either one (or both) could just as well be *orbital* angular momentum (for which, however, we would use the letter l).

³⁸For a proof you must look in a more advanced text; see, for instance, Claude Cohen-Tannoudji, Bernard Diu, and Franck Laloe, *Quantum Mechanics* (New York: John Wiley & Sons, 1977), Vol. 2, Chapter X.

Table 4.7: Clebsch-Gordan coefficients. (A square root sign is understood for every entry; the minus sign, if present, goes *outside* the radical.)

form, with $s_1 = s_2 = 1/2$ (I used the informal notation $\uparrow = |\frac{1}{2} \frac{1}{2}\rangle$, $\downarrow = |\frac{1}{2} (-\frac{1}{2})\rangle$). The constants $C_{m_1 m_2 m}^{s_1 s_2 s}$ are called **Clebsch-Gordan coefficients**. A few of the simplest cases are listed in Table 4.7.³⁹ For example, the shaded column of the 2×1 table tells us that

$$|2 \ 1\rangle = \frac{1}{\sqrt{3}}|2 \ 2\rangle|1 \ -1\rangle + \frac{1}{\sqrt{6}}|2 \ 1\rangle|1 \ 0\rangle - \frac{1}{\sqrt{2}}|2 \ 0\rangle|1 \ 1\rangle.$$

In particular, if two particles (of spin 2 and spin 1) are at rest in a box, and the total spin is 2, and its z -component is 1, then a measurement of $S_z^{(1)}$ could return the value $2\hbar$ (with probability $1/3$), or \hbar (with probability $1/6$), or 0 (with probability $1/2$). Notice that the probabilities add up to 1 (the sum of the squares of any column on the Clebsch-Gordan table is 1).

These tables also work the other way around:

$$|s_1 \ m_1\rangle|s_2 \ m_2\rangle = \sum_s C_{m_1 m_2 m}^{s_1 s_2 s} |s \ m\rangle. \quad [4.186]$$

For example, the shaded row in the $3/2 \times 1$ table tells us that

$$|\frac{3}{2} \ \frac{1}{2}\rangle|1 \ 0\rangle = \sqrt{\frac{3}{5}}|\frac{5}{2} \ \frac{1}{2}\rangle + \sqrt{\frac{1}{15}}|\frac{3}{2} \ \frac{1}{2}\rangle - \sqrt{\frac{1}{3}}|\frac{1}{2} \ \frac{1}{2}\rangle.$$

³⁹The general formula is derived in Arno Bohm, *Quantum Mechanics: Foundations and Applications*, 2nd ed. (New York: Springer-Verlag, 1986), p. 172.

If you put particles of spin $3/2$ and spin 1 in the box, and you know that the first has $m_1 = 1/2$ and the second has $m_2 = 0$ (so m is necessarily $1/2$), and you measured the total spin s , you could get $5/2$ (with probability $3/5$), or $3/2$ (with probability $1/5$), or $1/2$ (with probability $1/3$). Again, the sum of the probabilities is 1 (the sum of the squares of each row on the Clebsch-Gordan table is 1).

If you think this is starting to sound like mystical numerology, I don't blame you. We will not be using the Clebsch-Gordan tables much in the rest of the book, but I wanted you to know where they fit into the scheme of things, in case you encounter them later on. In a mathematical sense this is all applied **group theory**—what we are talking about is the decomposition of the direct product of two irreducible representations of the rotation group into a direct sum of irreducible representations. (You can quote that to impress your friends.)

***Problem 4.35**

- (a) Apply S_- to $|1\ 0\rangle$ (Equation 4.177), and confirm that you get $\sqrt{2}\hbar|1\ -1\rangle$.
- (b) Apply S_{\pm} to $|0\ 0\rangle$ (Equation 4.178), and confirm that you get zero.
- (c) Show that $|1\ 1\rangle$ and $|1\ -1\rangle$ (Equation 4.177) are eigenstates of S^2 , with the appropriate eigenvalue.

Problem 4.36 Quarks carry spin $1/2$. Three quarks bind together to make a **baryon** (such as the proton or neutron); two quarks (or more precisely a quark and an antiquark) bind together to make a **meson** (such as the pion or the kaon). Assume the quarks are in the ground state (so the *orbital* angular momentum is zero).

- (a) What spins are possible for baryons?
- (b) What spins are possible for mesons?

Problem 4.37

- (a) A particle of spin 1 and a particle of spin 2 are at rest in a configuration such that the total spin is 3, and its z -component is 1 (that is, the eigenvalue of S_z is \hbar). If you measured the z -component of the angular momentum of the spin-2 particle, what values might you get, and what is the probability of each one?
- (b) An electron with spin down is in the state ψ_{510} of the hydrogen atom. If you could measure the total angular momentum squared of the electron alone (not including the proton spin), what values might you get, and what is the probability of each?

Problem 4.38 Determine the commutator of S^2 with $S_z^{(1)}$ (where $\mathbf{S} \equiv \mathbf{S}^{(1)} + \mathbf{S}^{(2)}$). Generalize your result to show that

$$[S^2, \mathbf{S}^{(1)}] = 2i\hbar(\mathbf{S}^{(1)} \times \mathbf{S}^{(2)}). \quad [4.187]$$

Note: Because $S_z^{(1)}$ does not commute with S^2 , we cannot hope to find states that are simultaneous eigenvectors of both. To form eigenstates of S^2 , we need linear combinations of eigenstates of $S_z^{(1)}$. This is precisely what the Clebsch-Gordan coefficients (in Equation 4.185) do for us. On the other hand, it follows by obvious inference from Equation 4.187 that the sum $\mathbf{S}^{(1)} + \mathbf{S}^{(2)}$ *does* commute with S^2 , which only confirms what we already knew (see Equation 4.103).

FURTHER PROBLEMS FOR CHAPTER 4

***Problem 4.39** Consider the **three-dimensional harmonic oscillator**, for which the potential is

$$V(r) = \frac{1}{2}m\omega^2 r^2. \quad [4.188]$$

(a) Show that separation of variables in Cartesian coordinates turns this into three one-dimensional oscillators, and exploit your knowledge of the latter to determine the allowed energies. *Answer:*

$$E_n = (n + 3/2)\hbar\omega. \quad [4.189]$$

(b) Determine the degeneracy $d(n)$ of E_n .

*****Problem 4.40** Because the three-dimensional harmonic oscillator potential (Equation 4.188) is spherically symmetric, the Schrödinger equation can be handled by separation of variables in *spherical* coordinates as well as Cartesian coordinates. Use the power series method to solve the radial equation. Find the recursion formula for the coefficients, and determine the allowed energies. Check your answer against Equation 4.189.

****Problem 4.41**

(a) Prove the **three-dimensional virial theorem**

$$2\langle T \rangle = \langle \mathbf{r} \cdot \nabla V \rangle \quad [4.190]$$

(for stationary states). *Hint:* Refer to Problem 3.53.

(b) Apply the virial theorem to the case of hydrogen, and show that

$$\langle T \rangle = -E_n; \quad \langle V \rangle = 2E_n. \quad [4.191]$$

(c) Apply the virial theorem to the three-dimensional harmonic oscillator (Problem 4.39), and show that in this case

$$\langle T \rangle = \langle V \rangle = E_n/2. \quad [4.192]$$

*****Problem 4.42** The **momentum-space wave function** in three dimensions is defined by the natural generalization of Equation 3.132:

$$\phi(\mathbf{p}) \equiv \frac{1}{(2\pi\hbar)^{3/2}} \int e^{-i(\mathbf{p}\cdot\mathbf{r})/\hbar} \psi(\mathbf{r}) d^3\mathbf{r}. \quad [4.193]$$

- (a) Find the momentum-space wave function for the ground state of hydrogen (Equation 4.80). *Hint:* Use spherical coordinates, setting the polar axis along the direction of \mathbf{p} . Do the θ integral first. *Answer:*

$$\phi(\mathbf{p}) = \frac{1}{\pi} \left(\frac{2a}{\hbar} \right)^{3/2} \frac{1}{[1 + (ap/\hbar)^2]^2}. \quad [4.194]$$

- (b) Check that $\phi(\mathbf{p})$ is normalized.
 (c) Use $\phi(\mathbf{p})$ to calculate $\langle p^2 \rangle$.
 (d) What is the expectation value of the kinetic energy in this state? Express your answer as a multiple of E_1 , and check that it is consistent with the virial theorem (Equation 4.191).

Problem 4.43

- (a) Construct the spatial wave function (ψ) for hydrogen in the state $n = 3$, $l = 2$, $m = 1$. Express your answer as a function of r , θ , ϕ , and a (the Bohr radius) *only*—no other variables (ρ , z , etc.), or functions (Y , v , etc.), or constants (A , a_0 , etc.), or derivatives allowed (π is okay, and e , and 2, etc.).
 (b) Check that this wave function is properly normalized by carrying out the appropriate integrals over r , θ , and ϕ .
 (c) Find the expectation value of r^s in this state. For what range of s is the result finite?

*****Problem 4.44** Suppose two spin-1/2 particles are known to be in the singlet configuration (Equation 4.178). Let $S_a^{(1)}$ be the component of the spin angular momentum of particle number 1 in the direction defined by the unit vector \hat{a} . Similarly, let $S_b^{(2)}$ be the component of 2's angular momentum in the direction \hat{b} . Show that

$$\langle S_a^{(1)} S_b^{(2)} \rangle = -\frac{\hbar^2}{4} \cos \theta, \quad [4.195]$$

where θ is the angle between \hat{a} and \hat{b} .

*****Problem 4.45** Work out the Clebsch-Gordan coefficients for the case $s_1 = 1/2$, $s_2 = \text{anything}$. *Hint:* You're looking for the coefficients A and B in

$$|s m\rangle = A \left| \frac{1}{2} \frac{1}{2} \right\rangle |s_2 (m - \frac{1}{2})\rangle + B \left| \frac{1}{2} (-\frac{1}{2}) \right\rangle |s_2 (m + \frac{1}{2})\rangle,$$

such that $|s m\rangle$ is an eigenstate of S^2 . Use the method of Equations 4.179 through 4.182. If you can't figure out what $S_x^{(2)}$ (for instance) does to $|s_2 m_2\rangle$, refer back to Equations 4.136 and 4.144. Use this general result to construct the $(1/2) \times 1$ table of Clebsch-Gordan coefficients, and check it against Table 4.7. *Answer:*

$$A = \sqrt{\frac{s_2 \pm m + 1/2}{2s_2 + 1}}; \quad B = \pm \sqrt{\frac{s_2 \mp m + 1/2}{2s_2 + 1}},$$

where the signs are determined by $s = s_2 \pm 1/2$.

Problem 4.46 Find the matrix representing S_x for a particle of spin $3/2$ (using the basis of eigenstates of S_z). Solve the characteristic equation to determine the eigenvalues of S_x .

*****Problem 4.47** Work out the normalization factor for the spherical harmonics, as follows. From Section 4.1.2 we know that

$$Y_l^m = B_l^m e^{im\phi} P_l^m(\cos\theta);$$

the problem is to determine the factor B_l^m (which I quoted, but did not derive, in Equation 4.32). Use Equations 4.120, 4.121, and 4.130 to obtain a recursion relation giving B_l^{m+1} in terms of B_l^m . Solve it by induction on m to get B_l^m up to an overall constant $C(l)$. Finally, use the result of Problem 4.22 to fix the constant. You may find the following formula for the derivative of an associated Legendre function useful:

$$(1-x^2) \frac{dP_l^m}{dx} = \sqrt{1-x^2} P_l^{m+1} - mx P_l^m. \quad [4.196]$$

Problem 4.48 The electron in a hydrogen atom occupies the combined spin and position state

$$R_{21} \left(\sqrt{\frac{1}{3}} Y_1^0 \chi_+ + \sqrt{\frac{2}{3}} Y_1^1 \chi_- \right).$$

- (a) If you measured the orbital angular momentum squared (L^2), what values might you get, and what is the probability of each?
- (b) Same for the z-component of orbital angular momentum (L_z).
- (c) Same for the spin angular momentum squared (S^2).
- (d) Same for the z-component of spin angular momentum (S_z).

Let $\mathbf{J} \equiv \mathbf{L} + \mathbf{S}$ be the total angular momentum.

- (e) If you measured J^2 , what values might you get, and what is the probability of each?
- (f) Same for J_z .

- (g) If you measured the position of the particle, what is the probability density for finding it at r, θ, ϕ ?
- (h) If you measured both the z -component of the spin *and* the distance from the origin (note that these are compatible observables), what is the probability density for finding the particle with spin up and at radius r ?

*****Problem 4.49**

- (a) For a function $f(\phi)$ that can be expanded in a Taylor series, show that

$$f(\phi + \phi_0) = e^{iL_z\phi_0/\hbar} f(\phi)$$

(where ϕ_0 is any constant angle). For this reason, L_z/\hbar is called the **generator of rotations** about the z -axis. *Hint:* Use Equation 4.129, and refer to Problem 3.55.

More generally, $\mathbf{L} \cdot \hat{n}/\hbar$ is the generator of rotations about the direction \hat{n} , in the sense that $\exp(i\mathbf{L} \cdot \hat{n}\varphi/\hbar)$ effects a rotation through angle φ (in the right-hand sense) about the axis \hat{n} . In the case of spin, the generator of rotations is $\mathbf{S} \cdot \hat{n}/\hbar$. In particular, for spin 1/2

$$\chi' = e^{i(\boldsymbol{\sigma} \cdot \hat{n})\varphi/2} \chi \quad [4.197]$$

tells us how spinors rotate.

- (b) Construct the (2×2) matrix representing rotation by 180° about the x -axis, and show that it converts “spin up” (χ_+) into “spin down” (χ_-), as you would expect.
- (c) Construct the matrix representing rotation by 90° about the y -axis, and check what it does to χ_+ .
- (d) Construct the matrix representing rotation by 360° about the z -axis. If the answer is not quite what you expected, discuss its implications.
- (e) Show that

$$e^{i(\boldsymbol{\sigma} \cdot \hat{n})\varphi/2} = \cos(\varphi/2) + i(\hat{n} \cdot \boldsymbol{\sigma}) \sin(\varphi/2). \quad [4.198]$$

****Problem 4.50** The fundamental commutation relations for angular momentum (Equations 4.98 and 4.99) allow for half-integer (as well as integer) eigenvalues. But for *orbital* angular momentum only the integer values occur. There must be some *extra* constraint in the specific form $\mathbf{L} = \mathbf{r} \times \mathbf{p}$ that excludes half-integer values.⁴⁰ Let a be some convenient constant with the dimensions of length (the Bohr radius, say, if we’re talking about hydrogen), and define the operators

$$\begin{aligned} q_1 &\equiv \frac{1}{\sqrt{2}} [x + (a^2/\hbar)p_y]; & p_1 &\equiv \frac{1}{\sqrt{2}} [p_x - (\hbar/a^2)y]; \\ q_2 &\equiv \frac{1}{\sqrt{2}} [x - (a^2/\hbar)p_y]; & p_2 &\equiv \frac{1}{\sqrt{2}} [p_x + (\hbar/a^2)y]. \end{aligned}$$

⁴⁰This problem is based on an argument in Ballentine, (footnote 34), page 127.

(a) Verify that $[q_1, q_2] = [p_1, p_2] = 0$; $[q_1, p_1] = [q_2, p_2] = i\hbar$. Thus the q 's and the p 's satisfy the canonical commutation relations for position and momentum, and those of index 1 are compatible with those of index 2.

(b) Show that

$$L_z = \frac{\hbar}{2a^2}(q_1^2 - q_2^2) + \frac{a^2}{2\hbar}(p_1^2 - p_2^2).$$

(c) Check that $L_z = H_1 - H_2$, where each H is the Hamiltonian for a harmonic oscillator with mass $m = \hbar/a^2$ and frequency $\omega = 1$.

(d) We know that the eigenvalues of the harmonic oscillator Hamiltonian are $(n + 1/2)\hbar\omega$, where $n = 0, 1, 2, \dots$ (in the algebraic theory of Section 2.3.1, this follows from the form of the Hamiltonian and the canonical commutation relations). Use this to conclude that the eigenvalues of L_z must be integers.

*****Problem 4.51** In classical electrodynamics the force on a particle of charge q moving with velocity \mathbf{v} through electric and magnetic fields \mathbf{E} and \mathbf{B} is given by the **Lorentz force law**:

$$\mathbf{F} = q(\mathbf{E} + \mathbf{v} \times \mathbf{B}). \quad [4.199]$$

This force cannot be expressed as the gradient of a scalar potential energy function, and therefore the Schrödinger equation in its original form (Equation 1.1) cannot accommodate it. But in the more sophisticated form

$$i\hbar \frac{\partial \Psi}{\partial t} = H\Psi \quad [4.200]$$

there is no problem; the classical Hamiltonian⁴¹ is

$$H = \frac{1}{2m}(\mathbf{p} - q\mathbf{A})^2 + q\varphi, \quad [4.201]$$

where \mathbf{A} is the vector potential ($\mathbf{B} = \nabla \times \mathbf{A}$) and φ is the scalar potential ($\mathbf{E} = -\nabla\varphi - \partial\mathbf{A}/\partial t$), so the Schrödinger equation (making the canonical substitution $\mathbf{p} \rightarrow (i/\hbar)\nabla$) becomes

$$i\hbar \frac{\partial \Psi}{\partial t} = \left[\frac{1}{2m} \left(\frac{\hbar}{i}\nabla - q\mathbf{A} \right)^2 + q\varphi \right] \Psi. \quad [4.202]$$

(a) Show that

$$\frac{d\langle \mathbf{r} \rangle}{dt} = \frac{1}{m} \langle (\mathbf{p} - q\mathbf{A}) \rangle. \quad [4.203]$$

⁴¹See, for example, H. Goldstein, *Classical Mechanics*, 2nd ed., Addison-Wesley, Reading, MA, 1980, page 346.

(b) As always (see Equation 1.32) we identify $d\langle\mathbf{r}\rangle/dt$ with $\langle\mathbf{v}\rangle$. Show that

$$m \frac{d\langle\mathbf{v}\rangle}{dt} = q\langle\mathbf{E}\rangle + \frac{q}{2m}\langle(\mathbf{p} \times \mathbf{B} - \mathbf{B} \times \mathbf{p})\rangle - \frac{q^2}{m}\langle(\mathbf{A} \times \mathbf{B})\rangle. \quad [4.204]$$

(c) In particular, if the fields \mathbf{E} and \mathbf{B} are *uniform* over the volume of the wave packet, show that

$$m \frac{d\langle\mathbf{v}\rangle}{dt} = q(\mathbf{E} + \langle\mathbf{v}\rangle \times \mathbf{B}), \quad [4.205]$$

so the *expectation value* of $\langle\mathbf{v}\rangle$ moves according to the Lorentz force law, as we would expect from Ehrenfest's theorem.

*****Problem 4.52** [Refer to Problem 4.51 for background.] Suppose

$$\mathbf{A} = \frac{B_0}{2}(x\hat{j} - y\hat{i}), \quad \text{and} \quad \varphi = Kz^2,$$

where B_0 and K are constants.

(a) Find the fields \mathbf{E} and \mathbf{B} .

(b) Find the allowed energies, for a particle of mass m and charge q , in these fields.

****Problem 4.53** [Refer to Problem 4.51 for background.] In classical electrodynamics the potentials \mathbf{A} and φ are not uniquely determined⁴²; the *physical* quantities are the *fields*, \mathbf{E} and \mathbf{B} .

(a) Show that the potentials

$$\varphi' \equiv \varphi - \frac{\partial\Lambda}{\partial t}, \quad \mathbf{A}' \equiv \mathbf{A} + \nabla\Lambda \quad [4.206]$$

(where Λ is an arbitrary real function of position and time) yield the same fields as φ and \mathbf{A} . Equation [4.206] is called a **gauge transformation**, and the theory is said to be **gauge invariant**.

(b) In quantum mechanics the potentials play a more direct role, and it is of interest to know whether the theory remains gauge invariant. Show that

$$\Psi' \equiv e^{iq\Lambda/\hbar}\Psi \quad [4.207]$$

satisfies the Schrödinger equation [4.202] with the gauge-transformed potentials φ' and \mathbf{A}' . Since Ψ' differs from Ψ only by a *phase factor*, it represents the

⁴²See, for example, Griffiths, (footnote 27), section 10.2.4.

same physical state⁴³, and the theory is gauge invariant (see Section 10.2.4 for further discussion).

⁴³That is to say, $\langle \mathbf{r} \rangle$, $d\langle \mathbf{r} \rangle/dt$, etc. are unchanged. Because Λ depends on position, $\langle \mathbf{p} \rangle$ (with \mathbf{p} represented by the operator $(\hbar/i)\nabla$) *does* change, but as we found in Equation [4.203], \mathbf{p} does not represent the mechanical momentum ($m\mathbf{v}$) in this context (in Lagrangian mechanics it is so-called **canonical momentum**).

CHAPTER 5

IDENTICAL PARTICLES

5.1 TWO-PARTICLE SYSTEMS

For a *single* particle, the wave function $\Psi(\mathbf{r}, t)$ is a function of the spatial coordinates \mathbf{r} and the time t (we'll ignore spin for the moment). The wave function for a *two*-particle system is a function of the coordinates of particle one (\mathbf{r}_1), the coordinates of particle two (\mathbf{r}_2), and the time:

$$\Psi(\mathbf{r}_1, \mathbf{r}_2, t). \quad [5.1]$$

Its time evolution is determined (as always) by the Schrödinger equation:

$$i\hbar \frac{\partial \Psi}{\partial t} = H\Psi, \quad [5.2]$$

where H is the Hamiltonian for the whole system:

$$H = -\frac{\hbar^2}{2m_1} \nabla_1^2 - \frac{\hbar^2}{2m_2} \nabla_2^2 + V(\mathbf{r}_1, \mathbf{r}_2, t) \quad [5.3]$$

(the subscript on ∇ indicates differentiation with respect to the coordinates of particle 1 or particle 2, as the case may be). The statistical interpretation carries over in the obvious way:

$$|\Psi(\mathbf{r}_1, \mathbf{r}_2, t)|^2 d^3\mathbf{r}_1 d^3\mathbf{r}_2 \quad [5.4]$$

is the probability of finding particle 1 in the volume $d^3\mathbf{r}_1$ and particle 2 in the volume $d^3\mathbf{r}_2$; evidently Ψ must be normalized in such a way that

$$\int |\Psi(\mathbf{r}_1, \mathbf{r}_2, t)|^2 d^3\mathbf{r}_1 d^3\mathbf{r}_2 = 1. \quad [5.5]$$

For time-independent potentials, we obtain a complete set of solutions by separation of variables:

$$\Psi(\mathbf{r}_1, \mathbf{r}_2, t) = \psi(\mathbf{r}_1, \mathbf{r}_2)e^{-iEt/\hbar}, \quad [5.6]$$

where the spatial wave function (ψ) satisfies the time-independent Schrödinger equation:

$$-\frac{\hbar^2}{2m_1}\nabla_1^2\psi - \frac{\hbar^2}{2m_2}\nabla_2^2\psi + V\psi = E\psi, \quad [5.7]$$

and E is the total energy of the system.

****Problem 5.1** Typically, the interaction potential depends only on the vector $\mathbf{r} \equiv \mathbf{r}_1 - \mathbf{r}_2$ separating the two particles. In that case the Schrödinger equation separates, if we change variables from $\mathbf{r}_1, \mathbf{r}_2$ to $\mathbf{r}, \mathbf{R} \equiv (m_1\mathbf{r}_1 + m_2\mathbf{r}_2)/(m_1 + m_2)$ (the center of mass).

- (a) Show that $\mathbf{r}_1 = \mathbf{R} + (\mu/m_1)\mathbf{r}$, $\mathbf{r}_2 = \mathbf{R} - (\mu/m_2)\mathbf{r}$, and $\nabla_1 = (\mu/m_2)\nabla_R + \nabla_r$, $\nabla_2 = (\mu/m_1)\nabla_R - \nabla_r$, where

$$\mu \equiv \frac{m_1m_2}{m_1 + m_2} \quad [5.8]$$

is the **reduced mass** of the system.

- (b) Show that the (time-independent) Schrödinger equation becomes

$$-\frac{\hbar^2}{2(m_1 + m_2)}\nabla_R^2\psi - \frac{\hbar^2}{2\mu}\nabla_r^2\psi + V(\mathbf{r})\psi = E\psi.$$

- (c) Solve by separation of variables, letting $\psi(\mathbf{R}, \mathbf{r}) = \psi_R(\mathbf{R})\psi_r(\mathbf{r})$. Note that ψ_R satisfies the one-particle Schrödinger equation, with the *total* mass ($m_1 + m_2$) in place of m , potential zero, and energy E_R , while ψ_r satisfies the one-particle Schrödinger equation with the *reduced* mass in place of m , potential $V(\mathbf{r})$, and energy E_r . The total energy is the sum: $E = E_R + E_r$. *Note:* What this tells us is that the center of mass moves like a free particle, and the *relative* motion (that is, the motion of particle 2 with respect to particle 1) is the same as if we had a *single* particle with the *reduced* mass, subject to the potential V . Exactly the same separation occurs in *classical* mechanics¹; it reduces the two-body problem to an equivalent one-body problem.

Problem 5.2 In view of Problem 5.1, we can correct for the motion of the nucleus in hydrogen by simply replacing the electron mass with the reduced mass:

- (a) Find (to two significant digits) the percent error in the binding energy of hydrogen (Equation 4.77) introduced by our use of m instead of μ .

¹See, for example, Jerry Marion, *Classical Dynamics*, 2nd ed. (New York: Academic Press 1970), Section 8.2.

- (b) Find the separation in wavelength between the red Balmer lines ($n = 3 \rightarrow n = 2$) for hydrogen and deuterium.
- (c) Find the binding energy of **positronium** (in which the proton is replaced by a positron—positrons have the same mass as electrons but opposite charge).
- (d) Suppose you wanted to confirm the existence of **muonic hydrogen**, in which the electron is replaced by a muon (same charge, but 206.77 times heavier). Where (i.e., at what wavelength) would you look for the “Lyman- α ” line ($n = 2 \rightarrow n = 1$)?
-

5.1.1 Bosons and Fermions

Suppose particle 1 is in the (one-particle) state $\psi_a(\mathbf{r})$, and particle 2 is in the state $\psi_b(\mathbf{r})$. In that case $\psi(\mathbf{r}_1, \mathbf{r}_2)$ is a simple *product*:

$$\psi(\mathbf{r}_1, \mathbf{r}_2) = \psi_a(\mathbf{r}_1)\psi_b(\mathbf{r}_2). \quad [5.9]$$

Of course, this assumes that we can tell the particles apart—otherwise it wouldn’t make any sense to claim that number 1 is in state ψ_a and number 2 is in state ψ_b ; all we could say is that *one* of them is in the state ψ_a and the *other* is in state ψ_b , but we wouldn’t know which is which. If we were talking about *classical* mechanics this would be a silly objection: You can *always* tell the particles apart, in principle—just paint one of them red and the other one blue, or stamp identification numbers on them, or hire private detectives to follow them around. But in quantum mechanics the situation is fundamentally different: You can’t paint an electron red, or pin a label on it, and a detective’s observations will inevitably and unpredictably alter the state, raising doubts as to whether the two had perhaps switched places. The fact is, all electrons are *utterly identical*, in a way that no two classical objects can ever be. It is not merely that *we* don’t happen to know which electron is which; *God* doesn’t know which is which, because there is *no such thing* as “this” electron, or “that” electron; all we can legitimately speak about is “an” electron.

Quantum mechanics neatly accommodates the existence of particles that are *indistinguishable in principle*: We simply construct a wave function that is *noncommittal* as to which particle is in which state. There are actually *two* ways to do it:

$$\psi_{\pm}(\mathbf{r}_1, \mathbf{r}_2) = A[\psi_a(\mathbf{r}_1)\psi_b(\mathbf{r}_2) \pm \psi_b(\mathbf{r}_1)\psi_a(\mathbf{r}_2)]. \quad [5.10]$$

Thus the theory admits two kinds of identical particles: **bosons**, for which we use the plus sign, and **fermions**, for which we use the minus sign. Photons and mesons are bosons; protons and electrons are fermions. It so happens that

$$\left\{ \begin{array}{l} \text{all particles with } \textit{integer} \text{ spin are bosons, and} \\ \text{all particles with } \textit{half-integer} \text{ spin are fermions.} \end{array} \right. \quad [5.11]$$

This connection between spin and “statistics” (as we shall see, bosons and fermions have quite different statistical properties) can be *proved* in relativistic quantum mechanics; in the nonrelativistic theory it must be taken as an axiom.

It follows, in particular, that *two identical fermions* (for example, two electrons) *cannot occupy the same state*. For if $\psi_a = \psi_b$, then

$$\psi_-(\mathbf{r}_1, \mathbf{r}_2) = A[\psi_a(\mathbf{r}_1)\psi_a(\mathbf{r}_2) - \psi_a(\mathbf{r}_1)\psi_a(\mathbf{r}_2)] = 0,$$

and we are left with no wave function at all. This is the famous **Pauli exclusion principle**. It is not (as you may have been led to believe) a bizarre ad hoc assumption applying only to electrons, but rather a consequence of the rules for constructing two-particle wave functions, applying to *all* identical fermions.

I assumed, for the sake of argument, that one particle was in the state ψ_a and the other in state ψ_b , but there is a more general (and more sophisticated) way to formulate the problem. Let us define the **exchange operator** P which interchanges the two particles:

$$Pf(\mathbf{r}_1, \mathbf{r}_2) = f(\mathbf{r}_2, \mathbf{r}_1). \quad [5.12]$$

Clearly, $P^2 = 1$, and it follows (prove it for yourself) that the eigenvalues of P are ± 1 . If the two particles are identical, the Hamiltonian must treat them the same: $m_1 = m_2$ and $V(\mathbf{r}_1, \mathbf{r}_2) = V(\mathbf{r}_2, \mathbf{r}_1)$. It follows that P and H are compatible observables,

$$[P, H] = 0, \quad [5.13]$$

and hence we can find a complete set of functions that are simultaneous eigenstates of both. That is to say, we can find solutions to the Schrödinger equation that are either symmetric (eigenvalue $+1$) or antisymmetric (eigenvalue -1) under exchange:

$$\psi(\mathbf{r}_1, \mathbf{r}_2) = \pm\psi(\mathbf{r}_2, \mathbf{r}_1) \quad (+ \text{ for bosons, } - \text{ for fermions}). \quad [5.14]$$

Moreover, if a system starts out in such a state, it will remain in such a state. The *new* law (I'll call it the **symmetrization requirement**) is that for identical particles the wave function is not merely *allowed*, but *required* to satisfy Equation 5.14, with the plus sign for bosons and the minus sign for fermions.² This is the *general* statement, of which Equation 5.10 is a special case.

²It is sometimes suggested that the symmetrization requirement (Equation 5.14) is nothing new—that it is *forced* by the fact that P and H commute. This is false: It is perfectly possible to imagine a system of two *distinguishable* particles (say, an electron and a positron) for which the Hamiltonian is symmetric, and yet there is no requirement that the wave function be symmetric (or antisymmetric). But *identical* particles *have* to occupy symmetric or antisymmetric states, and this is a completely *new fundamental law*—on a par, logically, with Schrödinger's equation and the statistical interpretation. Of course, there didn't *have* to be any such things as identical particles; it could have been that every single particle in nature was clearly distinguishable from every other one. Quantum mechanics allows for the *possibility* of identical particles, and nature (being lazy) seized the opportunity. (But I'm not complaining—this makes matters enormously simpler!)

Example. Suppose we have two noninteracting³ particles, both of mass m , in the infinite square well (Section 2.2). The one-particle states are

$$\psi_n(x) = \sqrt{\frac{2}{a}} \sin\left(\frac{n\pi}{a}x\right), \quad E_n = n^2 K$$

(where $K \equiv \pi^2 \hbar^2 / 2ma^2$). If the particles are *distinguishable*, the composite wave functions are simple products:

$$\psi_{n_1 n_2}(x_1, x_2) = \psi_{n_1}(x_1) \psi_{n_2}(x_2), \quad E_{n_1 n_2} = (n_1^2 + n_2^2) K.$$

For example, the ground state is

$$\psi_{11} = \frac{2}{a} \sin(\pi x_1/a) \sin(\pi x_2/a), \quad E_{11} = 2K;$$

the first excited state is doubly degenerate:

$$\psi_{12} = \frac{2}{a} \sin(\pi x_1/a) \sin(2\pi x_2/a), \quad E_{12} = 5K,$$

$$\psi_{21} = \frac{2}{a} \sin(2\pi x_1/a) \sin(\pi x_2/a), \quad E_{21} = 5K;$$

and so on. If the two particles are identical *bosons*, the ground state is unchanged, but the first excited state is *nondegenerate*:

$$\frac{\sqrt{2}}{a} [\sin(\pi x_1/a) \sin(2\pi x_2/a) + \sin(2\pi x_1/a) \sin(\pi x_2/a)]$$

(still with energy $5K$). And if the particles are identical *fermions*, there is *no* state with energy $2K$; the ground state is

$$\frac{\sqrt{2}}{a} [\sin(\pi x_1/a) \sin(2\pi x_2/a) - \sin(2\pi x_1/a) \sin(\pi x_2/a)],$$

and its energy is $5K$.

*Problem 5.3

- (a) If ψ_a and ψ_b are orthogonal, and both normalized, what is the constant A in Equation 5.10?
- (b) If $\psi_a = \psi_b$ (and it is normalized), what is A ? (This case, of course, occurs only for bosons.)

³They pass right through one another—never mind how you would set this up in practice! I'll ignore spin—if this bothers you (after all, a spinless fermion is a contradiction in terms), assume they're in the same spin state.

Problem 5.4

- (a) Write down the Hamiltonian for two identical noninteracting particles in the infinite square well. Verify that the fermion ground state given in the example is an eigenfunction of H , with the appropriate eigenvalue.
- (b) Find the next two excited states (beyond the ones given in the example)—wave functions and energies—for each of the three cases (distinguishable, identical bosons, identical fermions).

5.1.2 Exchange Forces

To give you some sense of what the symmetrization requirement actually *does*, I'm going to work out a simple one-dimensional example. Suppose one particle is in state $\psi_a(x)$, and the other is in state $\psi_b(x)$, and these two states are orthogonal and normalized. If the two particles are distinguishable, and number 1 is the one in state ψ_a , then the combined wave function is

$$\psi(x_1, x_2) = \psi_a(x_1)\psi_b(x_2); \quad [5.15]$$

if they are identical bosons, the composite wave function is (see Problem 5.3 for the normalization)

$$\psi_+(x_1, x_2) = \frac{1}{\sqrt{2}}[\psi_a(x_1)\psi_b(x_2) + \psi_b(x_1)\psi_a(x_2)]; \quad [5.16]$$

and if they are identical fermions, it is

$$\psi_-(x_1, x_2) = \frac{1}{\sqrt{2}}[\psi_a(x_1)\psi_b(x_2) - \psi_b(x_1)\psi_a(x_2)]. \quad [5.17]$$

Let's calculate the expectation value of the square of the separation distance between the two particles,

$$\langle (x_1 - x_2)^2 \rangle = \langle x_1^2 \rangle + \langle x_2^2 \rangle - 2\langle x_1 x_2 \rangle. \quad [5.18]$$

Case 1: Distinguishable particles. For the wave function in Equation 5.15, we have

$$\langle x_1^2 \rangle = \int x_1^2 |\psi_a(x_1)|^2 dx_1 \int |\psi_b(x_2)|^2 dx_2 = \langle x^2 \rangle_a$$

(the expectation value of x^2 in the one-particle state ψ_a),

$$\langle x_2^2 \rangle = \int |\psi_a(x_1)|^2 dx_1 \int x_2^2 |\psi_b(x_2)|^2 dx_2 = \langle x^2 \rangle_b,$$

and

$$\langle x_1 x_2 \rangle = \int x_1 |\psi(x_1)|^2 dx_1 \int x_2 |\psi(x_2)|^2 dx_2 = \langle x \rangle_a \langle x \rangle_b.$$

In this case, then,

$$\langle (x_1 - x_2)^2 \rangle_d = \langle x^2 \rangle_a + \langle x^2 \rangle_b - 2\langle x \rangle_a \langle x \rangle_b. \quad [5.19]$$

(Incidentally, the answer would—of course—be the same if particle 1 had been in state ψ_b , and particle 2 in state ψ_a .)

Case 2: Identical particles. For the wave functions in Equations 5.16 and 5.17,

$$\begin{aligned} \langle x_1^2 \rangle &= \frac{1}{2} \left[\int x_1^2 |\psi_a(x_1)|^2 dx_1 \int |\psi_b(x_2)|^2 dx_2 \right. \\ &\quad + \int x_1^2 |\psi_b(x_1)|^2 dx_1 \int |\psi_a(x_2)|^2 dx_2 \\ &\quad \pm \int x_1^2 \psi_a(x_1)^* \psi_b(x_1) dx_1 \int \psi_b(x_2)^* \psi_a(x_2) dx_2 \\ &\quad \left. \pm \int x_1^2 \psi_b(x_1)^* \psi_a(x_1) dx_1 \int \psi_a(x_2)^* \psi_b(x_2) dx_2 \right] \\ &= \frac{1}{2} [\langle x^2 \rangle_a + \langle x^2 \rangle_b \pm 0 \pm 0] = \frac{1}{2} (\langle x^2 \rangle_a + \langle x^2 \rangle_b). \end{aligned}$$

Similarly,

$$\langle x_2^2 \rangle = \frac{1}{2} (\langle x^2 \rangle_b + \langle x^2 \rangle_a).$$

(Naturally, $\langle x_2^2 \rangle = \langle x_1^2 \rangle$, since you can't tell them apart.) But

$$\begin{aligned} \langle x_1 x_2 \rangle &= \frac{1}{2} \left[\int x_1 |\psi_a(x_1)|^2 dx_1 \int x_2 |\psi_b(x_2)|^2 dx_2 \right. \\ &\quad + \int x_1 |\psi_b(x_1)|^2 dx_1 \int x_2 |\psi_a(x_2)|^2 dx_2 \\ &\quad \pm \int x_1 \psi_a(x_1)^* \psi_b(x_1) dx_1 \int x_2 \psi_b(x_2)^* \psi_a(x_2) dx_2 \\ &\quad \left. \pm \int x_1 \psi_b(x_1)^* \psi_a(x_1) dx_1 \int x_2 \psi_a(x_2)^* \psi_b(x_2) dx_2 \right] \end{aligned}$$

$$\begin{aligned}
&= \frac{1}{2} (\langle x \rangle_a \langle x \rangle_b + \langle x \rangle_b \langle x \rangle_a \pm \langle x \rangle_{ab} \langle x \rangle_{ba} \pm \langle x \rangle_{ba} \langle x \rangle_{ab}) \\
&= \langle x \rangle_a \langle x \rangle_b \pm |\langle x \rangle_{ab}|^2,
\end{aligned}$$

where

$$\langle x \rangle_{ab} \equiv \int x \psi_a(x)^* \psi_b(x) dx. \quad [5.20]$$

Evidently

$$\langle (x_1 - x_2)^2 \rangle_{\pm} = \langle x^2 \rangle_a + \langle x^2 \rangle_b - 2\langle x \rangle_a \langle x \rangle_b \mp 2|\langle x \rangle_{ab}|^2. \quad [5.21]$$

Comparing Equations 5.19 and 5.21, we see that the difference resides in the final term:

$$\langle (\Delta x)^2 \rangle_{\pm} = \langle (\Delta x)^2 \rangle_d \mp 2|\langle x \rangle_{ab}|^2; \quad [5.22]$$

identical bosons (the upper signs) tend to be somewhat closer together, and identical fermions (the lower signs) somewhat farther apart, than distinguishable particles in the same two states. Notice that $\langle x \rangle_{ab}$ *vanishes* unless the two wave functions actually *overlap* [if $\psi_a(x)$ is zero wherever $\psi_b(x)$ is *nonzero*, the integral in Equation 5.20 is itself zero]. So if ψ_a represents an electron in an atom in Chicago and ψ_b represents an electron in an atom in Seattle, it's not going to make any difference whether you antisymmetrize the wave function or not. As a *practical* matter, therefore, it's okay to pretend that electrons with nonoverlapping wave functions are distinguishable (Indeed, this is the only thing that allows physicists and chemists to proceed at *all*, for in *principle* every electron in the universe is linked to every other one via the antisymmetrization of their wave functions, and if this really *mattered*, you wouldn't be able to talk about any *one* electron until you were prepared to deal with them *all*!)

The *interesting* case is when there *is* some overlap of the wave functions. The system behaves as though there were a "force of attraction" between identical bosons, pulling them closer together, and a "force of repulsion" between identical fermions, pushing them apart. We call it an **exchange force**, although it's not really a force at all—no physical agency is pushing on the particles; rather, it is a purely *geometrical* consequence of the symmetrization requirement. It is also a strictly quantum mechanical phenomenon, with no classical counterpart. Nevertheless, it has profound consequences. Consider, for example, the hydrogen molecule (H_2). Roughly speaking, the ground state consists of one electron in the atomic ground state (Equation 4.80) centered on nucleus 1, and one electron in the atomic ground state centered at nucleus 2. If electrons were *bosons*, the symmetrization requirement (or, if you like, the "exchange force") would tend to concentrate the electrons toward the middle, between the two protons (Figure 5.1a), and the resulting accumulation of negative charge would attract the protons inward, accounting for the **covalent bond** that holds

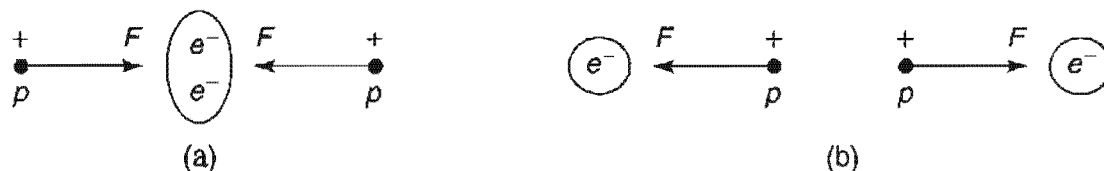

Figure 5.1: Schematic picture of the covalent bond; (a) Symmetric configuration produces attractive force; (b) antisymmetric configuration produces repulsive force.

the molecule together. Unfortunately, electrons *aren't* bosons, they're fermions, and this means that the concentration of negative charge should actually be shifted to the wings (Figure 5.1b), tearing the molecule apart!

But wait. We have been ignoring *spin*. The *complete* state of the electron includes not only its position wave function, but also a spinor, describing the orientation of its spin⁴:

$$\psi(\mathbf{r})\chi(s). \quad [5.23]$$

When we put together the two-electron state, it is the *whole works*, not just the spatial part, that has to be antisymmetric with respect to exchange. Now, a glance back at the composite spin states (Equations 4.177 and 4.178) reveals that the singlet combination is antisymmetric (and hence would have to be joined with a *symmetric* spatial function), whereas the three triplet states are all symmetric (and would require an *antisymmetric* spatial function). Evidently, then, the singlet state should lead to *bonding*, and the triplet to *antibonding*. Sure enough, the chemists tell us that covalent bonding requires the two electrons to occupy the singlet state, with total spin zero.⁵

***Problem 5.5** Imagine two noninteracting particles, each of mass m , in the infinite square well. If one is in the state ψ_n (Equation 2.24) and the other in state ψ_m orthogonal to ψ_n , calculate $\langle (x_1 - x_2)^2 \rangle$, assuming that (a) they are distinguishable particles, (b) they are identical bosons, and (c) they are identical fermions.

Problem 5.6 Suppose you had *three* particles, one in state $\psi_a(x)$, one in state $\psi_b(x)$, and one in state $\psi_c(x)$. Assuming that ψ_a , ψ_b , and ψ_c are orthonormal, construct the three-particle states (analogous to Equations 5.15, 5.16, and 5.17) representing (a) distinguishable particles, (b) identical bosons, and (c) identical fermions. Keep in mind that (b) must be completely symmetric under interchange of *any pair* of particles, and (c) must be completely anti-symmetric in the same sense.) *Note:* There's a cute

⁴In the absence of coupling between spin and position, we are free to assume that the state is *separable* in its spin and spatial coordinates. This just says that the probability of getting spin up is independent of the *location* of the particle. In the *presence* of coupling, the general state would take the form of a linear combination: $\psi_+(\mathbf{r})\chi_+ + \psi_-(\mathbf{r})\chi_-$.

⁵In casual language, it is often said that the electrons are "oppositely aligned" (one with spin up, and the other with spin down). This is something of an oversimplification, since the same could be said of the $m = 0$ triplet state. The precise statement is that they are in the singlet configuration.

trick for constructing completely antisymmetric wave functions: Form the **Slater determinant**, whose first row is $\psi_a(x_1), \psi_b(x_1), \psi_c(x_1)$, etc., whose second row is $\psi_a(x_2), \psi_b(x_2), \psi_c(x_2)$, etc., and so on (this device works for any number of particles).

5.2 ATOMS

A neutral atom, of atomic number Z , consists of a heavy nucleus, with electric charge Ze , surrounded by Z electrons (mass m and charge $-e$). The Hamiltonian for this system is⁶

$$H = \sum_{j=1}^Z \left\{ -\frac{\hbar^2}{2m} \nabla_j^2 - \left(\frac{1}{4\pi\epsilon_0} \right) \frac{Ze^2}{r_j} \right\} + \frac{1}{2} \left(\frac{1}{4\pi\epsilon_0} \right) \sum_{j \neq k}^Z \frac{e^2}{|\mathbf{r}_j - \mathbf{r}_k|}. \quad [5.24]$$

The term in curly brackets represents the kinetic plus potential energy of the j th electron in the electric field of the nucleus; the second sum (which runs over all values of j and k except $j = k$) is the potential energy associated with the mutual repulsion of the electrons (the factor of $1/2$ in front corrects for the fact that the summation counts each pair twice). The problem is to solve Schrödinger's equation.

$$H\psi = E\psi, \quad [5.25]$$

for the wave function $\psi(\mathbf{r}_1, \mathbf{r}_2, \dots, \mathbf{r}_Z)$. Because electrons are identical fermions, however, not all solutions are acceptable: only those for which the complete state (position and spin),

$$\psi(\mathbf{r}_1, \mathbf{r}_2, \dots, \mathbf{r}_Z) \chi(\mathbf{s}_1, \mathbf{s}_2, \dots, \mathbf{s}_Z), \quad [5.26]$$

is antisymmetric with respect to interchange of any two electrons. In particular, no two electrons can occupy the *same* state.

Unfortunately, the Schrödinger equation with the Hamiltonian in Equation 5.24 cannot be solved exactly (at any rate, it *hasn't* been) except for the very simplest case. $Z = 1$ (hydrogen). In practice, one must resort to elaborate approximation methods. Some of these we shall explore in Part II; for now I plan only to sketch some of the qualitative features of the solutions, obtained by neglecting the electron repulsion term altogether. In section 5.2.1 we'll study the ground state and excited states of helium, and in section 5.2.2 we'll examine the ground states of higher atoms.

⁶I'm assuming the nucleus is *stationary*. The trick of accounting for nuclear motion by using the reduced mass (Problem 5.1) works only for the *two*-body problem—hydrogen; fortunately, the nucleus is so much more massive than the electrons that the correction is extremely small even in that case (see Problem 5.2a), and it is smaller still for the heavier atoms. There are more interesting effects, due to magnetic interactions associated with electron spin, relativistic corrections, and the finite size of the nucleus. We'll look into these in later chapters, but all of them are minute corrections to the "purely Coulombic" atom described by Equation 5.24.

Problem 5.7 Suppose you could find a solution $\psi(\mathbf{r}_1, \mathbf{r}_2, \dots, \mathbf{r}_Z)$ to the Schrödinger (Equation 5.25) for the Hamiltonian in Equation 5.24. Describe how you could construct from it a completely symmetric function and a completely antisymmetric function, which also satisfy the Schrödinger equation, with the same energy.

5.2.1 Helium

After hydrogen, the simplest atom is helium ($Z = 2$). The Hamiltonian,

$$H = \left\{ -\frac{\hbar^2}{2m} \nabla_1^2 - \frac{1}{4\pi\epsilon_0} \frac{2e^2}{r_1} \right\} + \left\{ -\frac{\hbar^2}{2m} \nabla_2^2 - \frac{1}{4\pi\epsilon_0} \frac{2e^2}{r_2} \right\} + \frac{1}{4\pi\epsilon_0} \frac{e^2}{|\mathbf{r}_1 - \mathbf{r}_2|}, \quad [5.27]$$

consists of two *hydrogenic* Hamiltonians (with nuclear charge $2e$), one for electron 1 and one for electron 2, together with a final term describing the repulsion of the two electrons. It is this last term that causes all the problems. If we simply *ignore* it, the Schrödinger equation separates, and the solutions can be written as products of *hydrogen* wave functions:

$$\psi(\mathbf{r}_1, \mathbf{r}_2) = \psi_{nlm}(\mathbf{r}_1) \psi_{n'l'm'}(\mathbf{r}_2), \quad [5.28]$$

only with half the Bohr radius (Equation 4.72), and four times the Bohr energies (Equation 4.70). The total energy would be

$$E = 4(E_n + E_{n'}), \quad [5.29]$$

where $E_n = -13.6/n^2$ eV. In particular, the ground state would be

$$\psi_0(\mathbf{r}_1, \mathbf{r}_2) = \psi_{100}(\mathbf{r}_1) \psi_{100}(\mathbf{r}_2) = \frac{8}{\pi a^3} e^{-2(r_1+r_2)/a} \quad [5.30]$$

(see Equation 4.80), and its energy would be

$$E_0 = 8(-13.6 \text{ eV}) = -109 \text{ eV}. \quad [5.31]$$

Because ψ_0 is a symmetric function, the spin state has to be *antisymmetric*, so the ground state of helium is a *singlet* configuration, with the spins “oppositely aligned”. The *actual* ground state of helium is indeed a singlet, but the experimentally determined energy is -78.975 eV, so the agreement is not very good. But this is hardly surprising: We ignored electron repulsion, which is certainly *not* a small contribution. It is clearly *positive* (see Equation 5.27), which is comforting—evidently it brings the total energy up from -109 to -79 eV (see Problem 5.10).

The excited states of helium consist of one electron in the hydrogenic ground state and the other in an excited state:

$$\psi_{nlm} \psi_{100}. \quad [5.32]$$

[If you try to put *both* electrons in excited states, one immediately drops to the ground state, releasing enough energy to knock the other one into the continuum ($E > 0$), leaving you with a helium ion (He^+) and a free electron. This is an interesting system in its own right—see Problem 5.8—but it is not our present concern.] We can construct from this both symmetric and antisymmetric combinations, in the usual way (Equation 5.10); the former go with the *antisymmetric* spin configuration (the singlet), and they are called **parahelium**, while the latter require a *symmetric* spin configuration (the triplet), and they are known as **orthohelium**. The ground state is necessarily parahelium; the excited states come in both forms. Because the symmetric spatial state brings the electrons closer together (as we discovered in Section 5.1.2), we expect a higher interaction energy in parahelium, and indeed it is experimentally confirmed that the parahelium states have somewhat higher energy than their orthohelium counterparts (see Figure 5.2).

Problem 5.8

- (a) Suppose you put both electrons in a helium atom into the $n = 2$ state; what would the energy of the emitted electron be?
- (b) Describe (quantitatively) the spectrum of the helium ion, He^+ .

Problem 5.9 Discuss (qualitatively) the energy level scheme for helium (a) if electrons were identical bosons, and (b) if electrons were distinguishable particles (but still with the same mass and charge). Pretend the electrons still have spin $1/2$.

**Problem 5.10

- (a) Calculate $\langle (1/|\mathbf{r}_1 - \mathbf{r}_2|) \rangle$ for the state ψ_0 (Equation 5.30). *Hint:* Do the $d^3\mathbf{r}_2$ integral first, using spherical coordinates and setting the polar axis along \mathbf{r}_1 , so that

$$|\mathbf{r}_1 - \mathbf{r}_2| = \sqrt{r_1^2 + r_2^2 - 2r_1r_2 \cos \theta_2}.$$

The θ_2 integral is easy, but be careful to take the *positive root*. You'll have to break the r_2 integral into two pieces, one ranging from 0 to r_1 , the other from r_1 to ∞ . *Answer:* $5/4a$.

- (b) Use your result in (a) to estimate the electron interaction energy in the ground state of helium. Express your answer in electron volts, and add it to E_0 (Equation 5.31) to get a corrected estimate of the ground-state energy. Compare the experimental value. *Note:* Of course, we're still working with an approximate wave function, so don't expect *perfect* agreement.
-

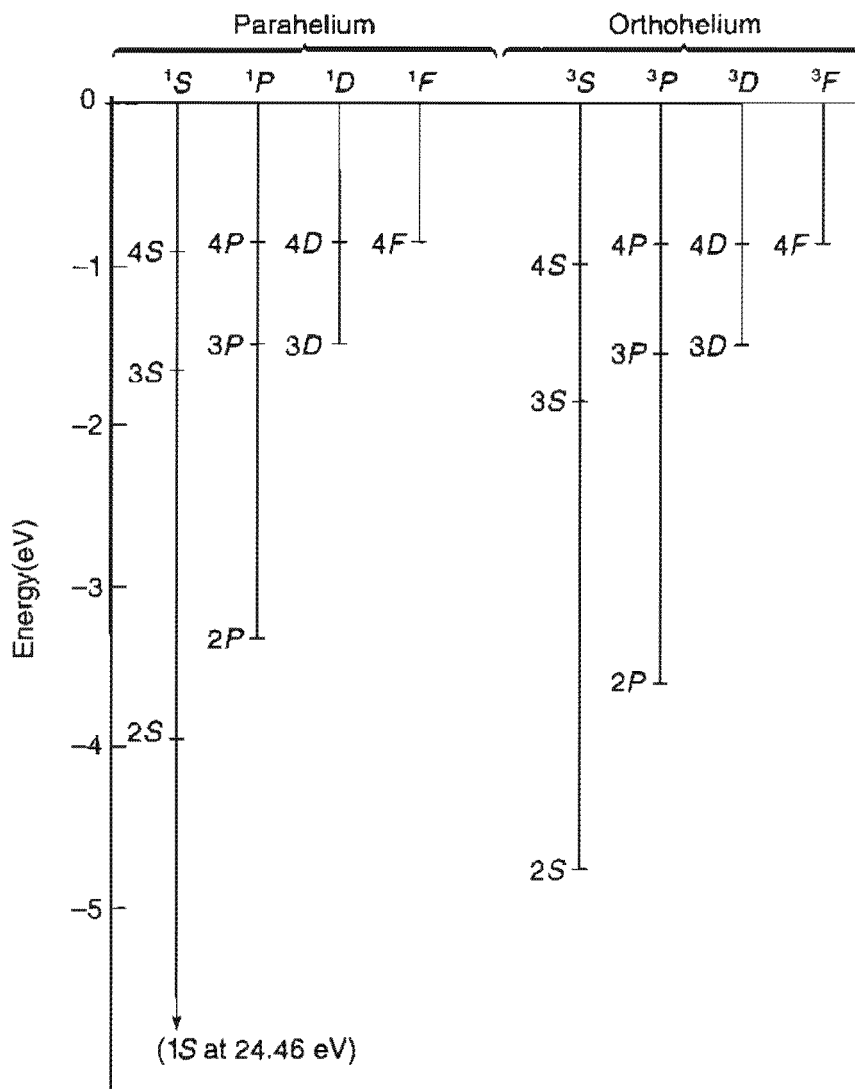

Figure 5.2: Energy level diagram for helium (the notation is explained in Section 5.2.2). Note that parahelium energies are uniformly higher than their orthohelium counterparts. The numerical values on the vertical scale are *relative* to the ground state of ionized helium (He^+): $4 \times (-13.6 \text{ eV}) = -54.4 \text{ eV}$; to get the *total* energy of the state, subtract 54.4 eV.

5.2.2 The Periodic Table

The ground-state electron configurations for heavier atoms can be pieced together in much the same way. To first approximation (ignoring their mutual repulsion altogether), the individual electrons occupy one-particle hydrogenic states (n, l, m), called **orbitals**, in the Coulomb potential of a nucleus with charge Ze . If electrons were bosons (or distinguishable particles), they would all shake down to the ground state (1,0,0), and chemistry would be very dull indeed. But electrons are in fact identical fermions, subject to the Pauli exclusion principle, so only *two* can occupy any given orbital (one with spin up, and one with spin down—or, more precisely, in the

singlet configuration). There are n^2 hydrogenic wave functions (all with the same energy E_n) for a given value of n , so the $n = 1$ shell has room for two electrons, the $n = 2$ shell holds eight, $n = 3$ takes 18, and in general the n th shell can accommodate $2n^2$ electrons. Qualitatively, the horizontal rows on the **Periodic Table** correspond to filling out each shell (if this were the whole story, they would have lengths 2, 8, 18, 32, 50, etc., instead of 2, 8, 8, 18, 18, etc.; we'll see in a moment how the electron-electron repulsion throws the counting off).

With helium, the $n = 1$ shell is filled, so the next atom, lithium ($Z = 3$), has to put one electron into the $n = 2$ shell. Now, for $n = 2$ we can have $l = 0$ or $l = 1$; which of these will the third electron choose? In the absence of electron-electron interactions, they both have the same energy (the Bohr energies depend on n , remember, but not on l). But the effect of electron repulsion is to favor the lowest value of l , for the following reason: Angular momentum tends to throw the electron outward (more formally, the expectation value of r increases with increasing l , for a given n), and the farther out an electron gets, the more effectively the inner electrons screen the nucleus (roughly speaking, the innermost electron "sees" the full nuclear charge Ze , but the outermost electron sees an effective charge hardly greater than e). Within a given shell, therefore, the state with lowest energy (which is to say, the most tightly bound electron) is $l = 0$, and the energy increases with increasing l . Thus the third electron in lithium occupies the orbital (2,0,0). The next atom (beryllium, with $Z = 4$) also fits into this state (only with "opposite spin"), but boron ($Z = 5$) has to make use of $l = 1$.

Continuing in this way, we reach neon ($Z = 10$), at which point the $n = 2$ shell is filled, and we advance to the next row of the periodic table and begin to populate the $n = 3$ shell. First there are two atoms (sodium and magnesium) with $l = 0$, and then there are six with $l = 1$ (aluminum through argon). Following argon there "should" be 10 atoms with $n = 3$ and $l = 2$; however, by this time the screening effect is so strong that it overlaps the next shell, so potassium ($Z = 19$) and calcium ($Z = 20$) choose $n = 4, l = 0$, in preference to $n = 3, l = 2$. After that we drop back to pick up the $n = 3, l = 2$ stragglers (scandium through zinc), followed by $n = 4, l = 1$ (gallium through krypton), at which point we again make a premature jump to the next row ($n = 5$) and wait until later to slip in the $l = 2$ and $l = 3$ orbitals from the $n = 4$ shell. For details of this intricate counterpoint, refer to any book on atomic physics.⁷

I would be delinquent if I failed to mention the archaic nomenclature for atomic states, because all chemists and most physicists use it (and the people who make up the Graduate Record Exam *love* this kind of thing). For reasons known best to nineteenth-century spectroscopists, $l = 0$ is called *s* (for "sharp"), $l = 1$ is *p* (for "principal"), $l = 2$ is *d* ("diffuse"), and $l = 3$ is *f* ("fundamental"); after that I guess they ran out of

⁷See, for example, U. Fano and L. Fano, *Basic Physics of Atoms and Molecules* (New York: John Wiley & Sons, 1959), Chapter 18, or the classic by G. Herzberg, *Atomic Spectra and Atomic Structure* (New York: Dover, 1944).

imagination, because the list just continues alphabetically (*g, h, i, etc.*).⁸ The state of a particular electron is represented by the pair nl , with n (the number) giving the shell and l (the letter) specifying the orbital angular momentum; the magnetic quantum number m is not listed, but an exponent is used to indicate the number of electrons that occupy the state in question. Thus the configuration

$$(1s)^2(2s)^2(2p)^2 \quad [5.33]$$

tells us that there are two electrons in the orbital (1,0,0), two in the orbital (2,0,0), and two in some combination of the orbitals (2,1,1), (2,1,0), and (2,1,-1). This happens to be the ground state of carbon.

In that example there are two electrons with orbital angular momentum quantum number 1, so the total orbital angular momentum quantum number L (capital L , instead of l , to indicate that this pertains to the *total*, not to any one particle) could be 2, 1, or 0. Meanwhile, the two (1s) electrons are locked together in the singlet state, with total spin zero, and so are the two (2s) electrons, but the two (2p) electrons could be in the singlet configuration or the triplet configuration. So the total spin quantum number S (capital, again, because it's the *total*) could be 1 or 0. Evidently the *grand total* (orbital plus spin) J could be 3, 2, 1, or 0. There exist rituals (**Hund's rules**⁹) for figuring out what these totals will be, for a particular atom. The result is recorded as the following hieroglyphic:

$${}^{2S+1}L_J \quad [5.34]$$

(where S and J are the numbers, and L the letter—capitalized, this time, because we're talking about the *totals*). The ground state of carbon happens to be 3P_0 : The total spin is 1 (hence the 3), the total orbital angular momentum is 1 (hence the P), and the *grand total* angular momentum is zero (hence the 0). In Table 5.1 the individual configurations and the total angular momenta (in the notation of Equation 5.34) are listed, for the first four rows of the Periodic Table.

***Problem 5.11

- (a) Figure out the electron configurations (in the notation of Equation 5.33) for the first two rows of the Periodic Table (up to neon), and check your results against Table 5.1.
- (b) Figure out the corresponding total angular momenta, in the notation of Equation [5.34], for the first four elements. List all the possibilities for boron, carbon, and nitrogen.

⁸The shells themselves are assigned equally arbitrary nicknames, starting (don't ask me why) with K : the K shell is $n = 1$, the L shell is $n = 2$, M is $n = 3$, and so on (at least they're in alphabetical order).

⁹See, for example, Stephen Gasiorowicz, *Quantum Physics* (New York: John Wiley & Sons, 1974), Chapters 18 and 19.

Table 5.1: Ground-state electron configurations for the first four rows of the Periodic Table.

| Z | Element | Configuration | |
|----|---------|--|-------------|
| 1 | H | (1s) | $^2S_{1/2}$ |
| 2 | He | (1s) ² | 1S_0 |
| 3 | Li | (He)(2s) | $^2S_{1/2}$ |
| 4 | Be | (He)(2s) ² | 1S_0 |
| 5 | B | (He)(2s) ² (2p) | $^2P_{1/2}$ |
| 6 | C | (He)(2s) ² (2p) ² | 3P_0 |
| 7 | N | (He)(2s) ² (2p) ³ | $^4S_{3/2}$ |
| 8 | O | (He)(2s) ² (2p) ⁴ | 3P_2 |
| 9 | F | (He)(2s) ² (2p) ⁵ | $^2P_{3/2}$ |
| 10 | Ne | (He)(2s) ² (2p) ⁶ | 1S_0 |
| 11 | Na | (Ne)(3s) | $^2S_{1/2}$ |
| 12 | Mg | (Ne)(3s) ² | 1S_0 |
| 13 | Al | (Ne)(3s) ² (3p) | $^2P_{1/2}$ |
| 14 | Si | (Ne)(3s) ² (3p) ² | 3P_0 |
| 15 | P | (Ne)(3s) ² (3p) ³ | $^4S_{3/2}$ |
| 16 | S | (Ne)(3s) ² (3p) ⁴ | 3P_2 |
| 17 | Cl | (Ne)(3s) ² (3p) ⁵ | $^2P_{3/2}$ |
| 18 | Ar | (Ne)(3s) ² (3p) ⁶ | 1S_0 |
| 19 | K | (Ar)(4s) | $^2S_{1/2}$ |
| 20 | Ca | (Ar)(4s) ² | 1S_0 |
| 21 | Sc | (Ar)(4s) ² (3d) | $^2D_{3/2}$ |
| 22 | Ti | (Ar)(4s) ² (3d) ² | 3F_2 |
| 23 | V | (Ar)(4s) ² (3d) ³ | $^4F_{3/2}$ |
| 24 | Cr | (Ar)(4s)(3d) ⁵ | 7S_3 |
| 25 | Mn | (Ar)(4s) ² (3d) ⁵ | $^6S_{3/2}$ |
| 26 | Fe | (Ar)(4s) ² (3d) ⁶ | 5D_4 |
| 27 | Co | (Ar)(4s) ² (3d) ⁷ | $^4F_{9/2}$ |
| 28 | Ni | (Ar)(4s) ² (3d) ⁸ | 3F_4 |
| 29 | Cu | (Ar)(4s)(3d) ¹⁰ | $^2S_{1/2}$ |
| 30 | Zn | (Ar)(4s) ² (3d) ¹⁰ | 1S_0 |
| 31 | Ga | (Ar)(4s) ² (3d) ¹⁰ (4p) | $^2P_{1/2}$ |
| 32 | Ge | (Ar)(4s) ² (3d) ¹⁰ (4p) ² | 3P_0 |
| 33 | As | (Ar)(4s) ² (3d) ¹⁰ (4p) ³ | $^4S_{3/2}$ |
| 34 | Se | (Ar)(4s) ² (3d) ¹⁰ (4p) ⁴ | 3P_2 |
| 35 | Br | (Ar)(4s) ² (3d) ¹⁰ (4p) ⁵ | $^2P_{3/2}$ |
| 36 | Kr | (Ar)(4s) ² (3d) ¹⁰ (4p) ⁶ | 1S_0 |

(c) **Hund's first rule** says that, all other things being equal, the state with the highest total spin will have the lowest energy. What would this predict in the case of the excited states of helium?

- (d) **Hund's second rule** says that if a subshell (n, l) is no more than half filled, then the lowest energy level has $J = |L - S|$; if it is more than half filled, then $J = L + S$ has the lowest energy. Use this to resolve the boron ambiguity in (b).
- (e) Use Hund's rules and the fact that a symmetric spin state must go with an antisymmetric position state (and vice versa) to resolve the carbon ambiguity in (b). What can you say about nitrogen?

Problem 5.12 The ground state of dysprosium (element 66, in the sixth row of the Periodic Table) is listed as 5I_8 . What are the total spin, total orbital, and grand total angular momentum quantum numbers? Suggest a likely electron configuration for dysprosium.

5.3 SOLIDS

In the solid state, a few of the loosely bound outermost **valence** electrons in each atom become detached and roam around throughout the material, no longer subject only to the Coulomb field of a specific "parent" nucleus, but rather to the combined potential of the entire crystal lattice. In this section we will examine two extremely primitive models: first, the electron gas theory of Sommerfeld, which ignores *all* forces (except the confining boundaries), treating the wandering electrons as free particles in a box (the three-dimensional analog to an infinite square well); and second, Bloch's theory, which introduces a periodic potential representing the electrical attraction of the regularly spaced, positively charged, nuclei (but still ignores electron-electron repulsion). These models are no more than the first halting steps toward a quantum theory of solids, but already they reveal the critical role of the Pauli exclusion principle in accounting for the "solidity" of solids, and provide illuminating insight into the remarkable electrical properties of conductors, semiconductors, and insulators.

5.3.1 The Free Electron Gas

Suppose the object in question is a rectangular solid, with dimensions l_x, l_y, l_z , and imagine that an electron inside experiences no forces at all, except at the impenetrable walls:

$$V(x, y, z) = \begin{cases} 0, & \text{if } (0 < x < l_x, 0 < y < l_y, 0 < z < l_z); \\ \infty, & \text{otherwise.} \end{cases} \quad [5.35]$$

The Schrödinger equation,

$$-\frac{\hbar^2}{2m} \nabla^2 \psi = E \psi,$$

separates in Cartesian coordinates: $\psi(x, y, z) = X(x)Y(y)Z(z)$, with

$$-\frac{\hbar^2}{2m} \frac{d^2 X}{dx^2} = E_x X, \quad -\frac{\hbar^2}{2m} \frac{d^2 Y}{dy^2} = E_y Y, \quad -\frac{\hbar^2}{2m} \frac{d^2 Z}{dz^2} = E_z Z,$$

and $E = E_x + E_y + E_z$. Letting

$$k_x \equiv \frac{\sqrt{2mE_x}}{\hbar}, \quad k_y \equiv \frac{\sqrt{2mE_y}}{\hbar}, \quad k_z \equiv \frac{\sqrt{2mE_z}}{\hbar},$$

we obtain the general solutions

$$X(x) = A_x \sin(k_x x) + B_x \cos(k_x x), \quad Y(y) = A_y \sin(k_y y) + B_y \cos(k_y y),$$

$$Z(z) = A_z \sin(k_z z) + B_z \cos(k_z z).$$

The boundary conditions require that $X(0) = Y(0) = Z(0) = 0$, so $B_x = B_y = B_z = 0$, and $X(l_x) = Y(l_y) = Z(l_z) = 0$, so

$$k_x l_x = n_x \pi, \quad k_y l_y = n_y \pi, \quad k_z l_z = n_z \pi, \quad [5.36]$$

where each n is a positive integer:

$$n_x = 1, 2, 3, \dots, \quad n_y = 1, 2, 3, \dots, \quad n_z = 1, 2, 3, \dots \quad [5.37]$$

The (normalized) wave functions are

$$\psi_{n_x n_y n_z} = \sqrt{\frac{8}{l_x l_y l_z}} \sin\left(\frac{n_x \pi}{l_x} x\right) \sin\left(\frac{n_y \pi}{l_y} y\right) \sin\left(\frac{n_z \pi}{l_z} z\right), \quad [5.38]$$

and the allowed energies are

$$E_{n_x n_y n_z} = \frac{\hbar^2 \pi^2}{2m} \left(\frac{n_x^2}{l_x^2} + \frac{n_y^2}{l_y^2} + \frac{n_z^2}{l_z^2} \right) = \frac{\hbar^2 k^2}{2m}, \quad [5.39]$$

where k is the magnitude of the **wave vector** $\mathbf{k} = (k_x, k_y, k_z)$.

If you imagine a three-dimensional space, with axes k_x, k_y, k_z , and planes drawn in at $k_x = (\pi/l_x), (2\pi/l_x), (3\pi/l_x), \dots$, at $k_y = (\pi/l_y), (2\pi/l_y), (3\pi/l_y), \dots$, and at $k_z = (\pi/l_z), (2\pi/l_z), (3\pi/l_z), \dots$, each intersection point represents a distinct (one-particle) stationary state (Figure 5.3). Each block in this grid, and hence also each state, occupies a volume

$$\frac{\pi^3}{l_x l_y l_z} = \frac{\pi^3}{V} \quad [5.40]$$

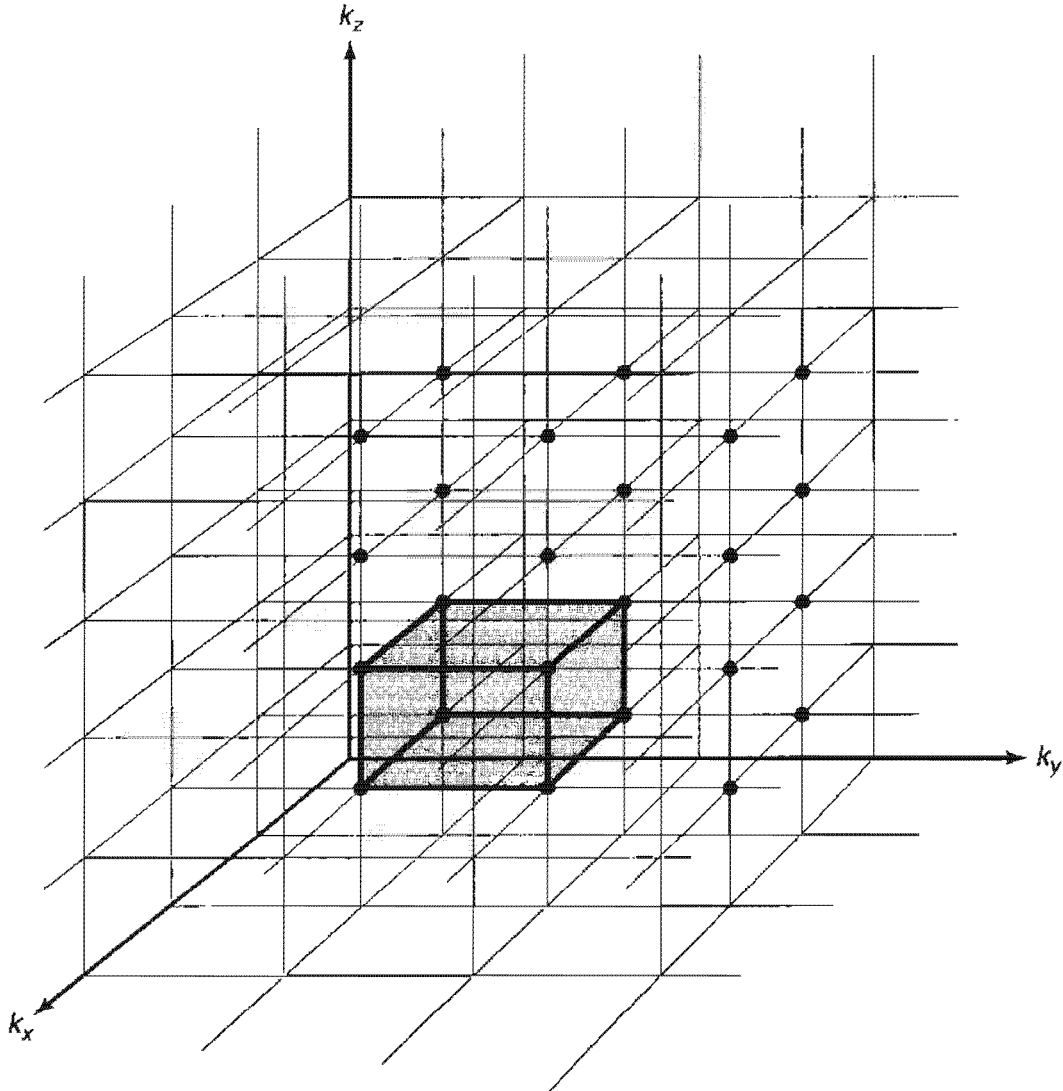

Figure 5.3: Free electron gas. Each intersection on the grid represents an allowed energy. Shading indicates one block; there is one state for every block.

of “ k -space,” where $V \equiv l_x l_y l_z$ is the spatial volume of the object itself. Now suppose our sample contains N atoms, and each atom contributes q free electrons. (In practice, N will be enormous—on the order of Avogadro’s number, for an object of macroscopic size.) If electrons were bosons (or distinguishable particles), they would all settle down to the ground state, ψ_{111} .¹⁰ But electrons are in fact identical fermions subject to the Pauli exclusion principle, so only two of them can occupy any given state. They will fill up one octant of a *sphere* in k -space,¹¹ whose radius k_F is determined by the fact that each pair of electrons requires a volume π^3/V (Equation 5.40):

¹⁰I’m assuming there is no appreciable thermal excitation, or other disturbance, to lift the solid out of its collective ground state. If you like, I’m talking about a “cold” solid, though (as you will show in Problem 5.13c), typical solids are still “cold,” in this sense, far above room temperature.

¹¹Because N is such a huge number, we need not worry about the distinction between the actual jagged edge of the grid and the smooth spherical surface that approximates it.

$$\frac{1}{8} \left(\frac{4}{3} \pi k_F^3 \right) = \frac{Nq}{2} \left(\frac{\pi^3}{V} \right).$$

Thus

$$k_F = (3\rho\pi^2)^{1/3}, \quad [5.41]$$

where

$$\rho \equiv \frac{Nq}{V} \quad [5.42]$$

is the *free electron density* (the number of free electrons per unit volume).

The boundary separating occupied and unoccupied states, in k -space, is called the **Fermi surface** (hence the subscript F). The maximum occupied energy is called the **Fermi energy** E_F ; evidently, for a free electron gas,

$$E_F = \frac{\hbar^2}{2m} (3\rho\pi^2)^{2/3}. \quad [5.43]$$

The *total energy* of the electron gas can be calculated as follows: a shell of thickness dk (Figure 5.4) contains a volume

$$\frac{1}{8} (4\pi k^2) dk,$$

so the number of electron states in the shell is

$$\frac{2[(1/2)\pi k^2 dk]}{(\pi^3/V)} = \frac{V}{\pi^2} k^2 dk.$$

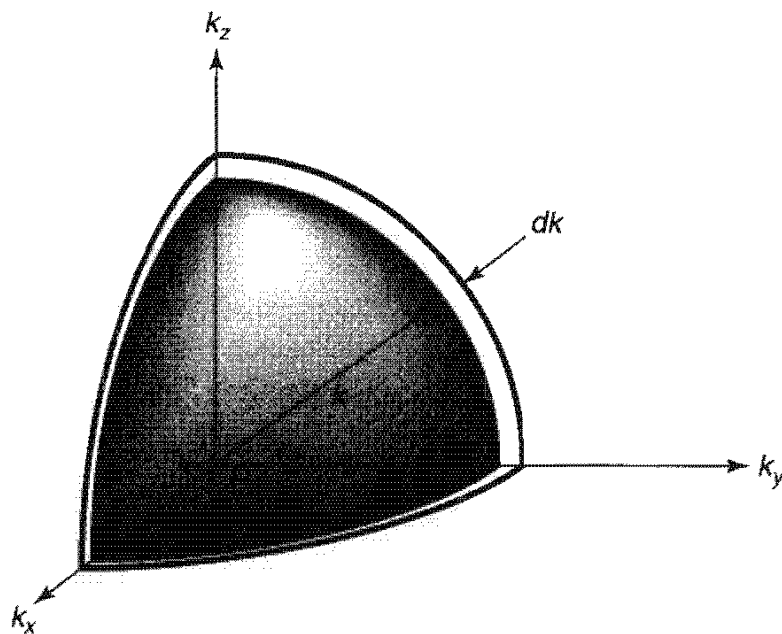

Figure 5.4: One octant of a spherical shell in k -space.

Each of these states carries an energy $\hbar^2 k^2/2m$ (Equation 5.39), so the energy of the shell is

$$dE = \frac{\hbar^2 k^2}{2m} \frac{V}{\pi^2} k^2 dk, \quad [5.44]$$

and hence the total energy is

$$E_{\text{tot}} = \frac{\hbar^2 V}{2\pi^2 m} \int_0^{k_F} k^4 dk = \frac{\hbar^2 k_F^5 V}{10\pi^2 m} = \frac{\hbar^2 (3\pi^2 Nq)^{5/3}}{10\pi^2 m} V^{-2/3}. \quad [5.45]$$

This quantum mechanical energy plays a role rather analogous to the internal thermal energy (U) of an ordinary gas. In particular, it exerts a pressure on the walls, for if the box expands by an amount dV , the total energy decreases:

$$dE_{\text{tot}} = -\frac{2}{3} \frac{\hbar^2 (3\pi^2 Nq)^{5/3}}{10\pi^2 m} V^{-5/3} dV = -\frac{2}{3} E_{\text{tot}} \frac{dV}{V},$$

and this shows up as work done on the outside ($dW = P dV$) by the quantum pressure P . Evidently

$$P = \frac{2}{3} \frac{E_{\text{tot}}}{V} = \frac{2}{3} \frac{\hbar^2 k_F^5}{10\pi^2 m} = \frac{(3\pi^2)^{2/3} \hbar^2}{5m} \rho^{5/3}. \quad [5.46]$$

Here, then, is a partial answer to the question of why a cold solid object doesn't simply *collapse*: There is a stabilizing internal pressure that has nothing to do with electron-electron repulsion (which we have ignored) or thermal motion (which we have excluded) but is strictly quantum mechanical, and derives ultimately from the antisymmetrization requirement for the wave functions of identical fermions. It is sometimes called **degeneracy pressure**, although "exclusion pressure" might be a better term.¹²

Problem 5.13 The density of copper is 8.96 gm/cm³, and its atomic weight is 63.5 gm/mole.

- (a) Calculate the Fermi energy for copper (Equation 5.43). Assume $q = 1$, and give your answer in electron volts.
- (b) What is the corresponding electron velocity [set $E_F = (1/2)mv^2$]? Is it safe to assume that the electrons in copper are nonrelativistic?
- (c) At what temperature would the characteristic thermal energy ($k_B T$, where k_B is the Boltzmann constant and T is the Kelvin temperature) equal the Fermi energy, for copper? *Note*: This is called the **Fermi temperature**. As long as the *actual* temperature is substantially below the Fermi temperature, the material can be regarded as "cold", with most of the electrons in the ground-state configuration. Since the melting point of copper is 1356 K, solid copper is *always* cold.

¹²We derived Equations 5.41, 5.43, 5.45, and 5.46 for the special case of an infinite rectangular well; but they hold for containers of any shape as long as the number of particles is extremely large.

- (d) Calculate the degeneracy pressure (Equation 5.46) of copper, in the electron gas model.

Problem 5.14 The **bulk modulus** of a substance is the ratio of a small decrease in pressure to the resulting fractional increase in volume:

$$B = -V \frac{dP}{dV}.$$

Show that $B = (5/3)P$, in the free electron gas model, and use your result in Problem 5.13(d) to estimate the bulk modulus of copper. *Note:* The observed value is 13.4×10^{10} N/m², but don't expect perfect agreement—after all, we're neglecting all electron-nucleus and electron-electron forces! Actually, it is rather surprising that this calculation comes as close as it *does*.

5.3.2 Band Structure

We're now going to improve on the free electron model by including the forces exerted on the electrons by the regularly spaced, positively charged, essentially stationary nuclei. The qualitative behavior of solids is dictated to a remarkable degree by the mere fact that this potential is *periodic*—its actual *shape* is relevant only to the finer details. To show you how it goes, I'm going to develop the simplest possible example: a one-dimensional **Dirac comb**, consisting of evenly spaced delta-function wells (Figure 5.5). But before I get to that, we need to know a bit about the general theory of periodic potentials.

Consider, then, a single particle subject to a periodic potential in one dimension:

$$V(x + a) = V(x). \quad [5.47]$$

Bloch's theorem tells us that the solutions to the Schrödinger equation,

$$-\frac{\hbar^2}{2m} \frac{d^2\psi}{dx^2} + V(x)\psi = E\psi, \quad [5.48]$$

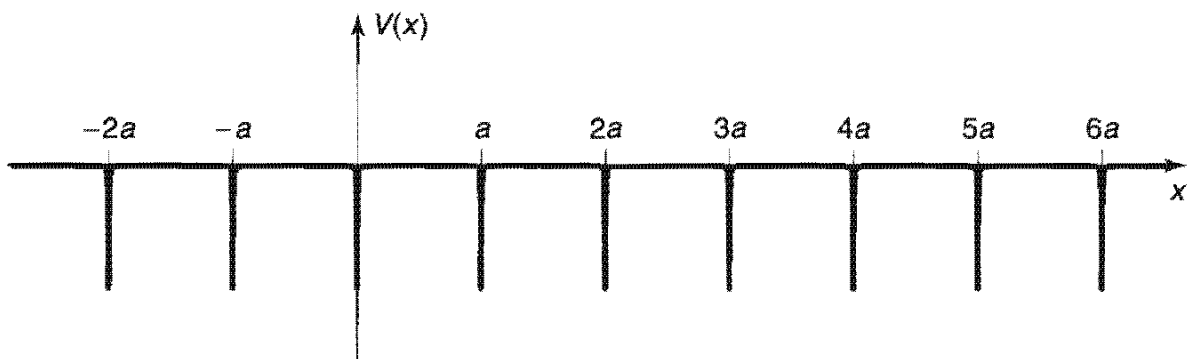

Figure 5.5: The Dirac comb, Equation 5.57.

for such a potential, can be taken to satisfy the condition

$$\psi(x + a) = e^{iKa} \psi(x) \quad [5.49]$$

for some constant K .

Proof: Let D be the “displacement” operator:

$$Df(x) = f(x + a). \quad [5.50]$$

By virtue of Equation 5.47, D commutes with the Hamiltonian:

$$[D, H] = 0, \quad [5.51]$$

and hence (see Section 3.4.1) we are free to choose eigenfunctions of H that are simultaneously eigenfunctions of D : $D\psi = \lambda\psi$, or

$$\psi(x + a) = \lambda\psi(x). \quad [5.52]$$

Now λ is certainly not zero [if it were, then—since Equation 5.52 holds for all x —we would immediately obtain $\psi(x) = 0$, which is not a permissible eigenfunction], so, like any nonzero complex number, it can be expressed as an exponential:

$$\lambda = e^{iKa} \quad [5.53]$$

for some constant K . QED.

At this stage Equation 5.53 is merely a strange way to write the eigenvalue λ , but in a moment we will discover that K is in fact *real*, so that although $\psi(x)$ itself is not periodic, $|\psi(x)|^2$ is:

$$|\psi(x + a)|^2 = |\psi(x)|^2, \quad [5.54]$$

as one would certainly expect.¹³

Of course, no *real* solid goes on forever, and the edges are going to spoil the periodicity of $V(x)$ and render Bloch’s theorem inapplicable. However, for any macroscopic crystal, containing something on the order of Avogadro’s number of atoms, it is hardly imaginable that edge effects can significantly influence the behavior of electrons deep inside. This suggests the following device to salvage Bloch’s theorem: We wrap the x -axis around in a circle and connect it onto its tail, after a large number $N \approx 10^{23}$ of periods; formally, we impose the boundary condition

$$\psi(x + Na) = \psi(x). \quad [5.55]$$

¹³Indeed, you might be tempted to reverse the argument, *starting* with Equation 5.54, as a way of proving Bloch’s theorem. It doesn’t work, for Equation 5.54 alone would allow the phase factor in Equation 5.49 to be a *function* of x .

It follows (from Equation 5.49) that

$$e^{iNKa}\psi(x) = \psi(x),$$

so $e^{iNKa} = 1$, or $NKa = 2\pi n$, or

$$K = \frac{2\pi n}{Na}, \quad (n = 0, \pm 1, \pm 2, \dots). \quad [5.56]$$

In particular, for this arrangement K is necessarily real. The virtue of Bloch's theorem is that we need only solve the Schrödinger equation within a *single cell* (say, on the interval $0 \leq x \leq a$); recursive application of Equation 5.49 generates the solution everywhere else.

Now suppose the potential consists of a long string of delta-function wells (the Dirac comb):

$$V(x) = -\alpha \sum_{j=0}^{N-1} \delta(x - ja). \quad [5.57]$$

The wells are supposed to represent, very crudely, the electrical attraction of the nuclei in the lattice. (In Figure 5.5 you must imagine that the x -axis has been “wrapped around,” as suggested in the previous paragraph, so the N th well actually appears at $x = -a$.) No one would pretend that this is a *realistic* model, but remember, it is only the effect of *periodicity* that concerns us here; the classic study¹⁴ used a repeating *rectangular* pattern, and many authors still prefer that one.¹⁵ In the region $0 < x < a$ the potential is zero, so

$$-\frac{\hbar^2}{2m} \frac{d^2\psi}{dx^2} = E\psi,$$

or

$$\frac{d^2\psi}{dx^2} = -k^2\psi,$$

where

$$k \equiv \frac{\sqrt{2mE}}{\hbar}, \quad [5.58]$$

as usual. (I'll work out the positive-energy solutions; the negative-energy states can be obtained in exactly the same way, using $\kappa \equiv \sqrt{-2mE}/\hbar$, or by simply substituting $k \rightarrow i\kappa$ in the final result [5.64].)

The general solution is

$$\psi(x) = A \sin(kx) + B \cos(kx), \quad (0 < x < a). \quad [5.59]$$

¹⁴R. de L. Kronig and W. G. Penney, *Proc. R. Soc. Lond.*, ser. A, **130**, 499 (1930).

¹⁵See, for instance, D. Park, *Introduction to the Quantum Theory*, 3rd ed., (New York: McGraw-Hill, 1992).

According to Bloch's theorem, the wave function in the cell immediately to the left of the origin is

$$\psi(x) = e^{-iKa} [A \sin k(x+a) + B \cos k(x+a)], \quad (-a < x < 0). \quad [5.60]$$

At $x = 0$, ψ must be continuous, so

$$B = e^{-iKa} [A \sin(ka) + B \cos(ka)]; \quad [5.61]$$

its derivative suffers a discontinuity proportional to the strength of the delta function (see Equation 2.107):

$$kA - e^{-iKa} k [A \cos(ka) - B \sin(ka)] = -\frac{2m\alpha}{\hbar^2} B. \quad [5.62]$$

Solving Equation 5.61 for $A \sin(ka)$ yields

$$A \sin(ka) = [e^{iKa} - \cos(ka)] B. \quad [5.63]$$

Substituting this into Equation 5.62, and canceling kB , we find

$$[e^{iKa} - \cos(ka)][1 - e^{-iKa} \cos(ka)] + e^{-iKa} \sin^2(ka) = -\frac{2m\alpha}{\hbar^2 k} \sin(ka),$$

which simplifies to

$$\cos(Ka) = \cos(ka) - \frac{m\alpha}{\hbar^2 k} \sin(ka). \quad [5.64]$$

This is the fundamental result from which all else follows. For the Kronig-Penney potential (see footnote 15), the formula is more complicated, but it shares the qualitative features we are about to explore.

Equation 5.64 determines the possible values of k , and hence the allowed energies. To simplify the notation, let

$$z \equiv ka, \quad \text{and} \quad \beta \equiv \frac{m\alpha a}{\hbar^2}, \quad [5.65]$$

so the right side of Equation 5.64 can be written

$$f(z) = \cos(z) - \beta \frac{\sin(z)}{z}. \quad [5.66]$$

The constant β is a dimensionless measure of the "strength" of the delta function. In Figure 5.6 I have plotted $f(z)$ for the case $\beta = 1$. The important thing to notice is that $f(z)$ strays outside the range $(-1, +1)$, and in such regions there is no hope of solving Equation 5.64, since $|\cos(Ka)| \leq 1$. These **gaps** represent forbidden energies; they are separated by **bands** of allowed energies. Within a given band, virtually any energy is allowed, for according to Equation 5.56 $Ka = 2\pi n/N$, where N is a huge number,

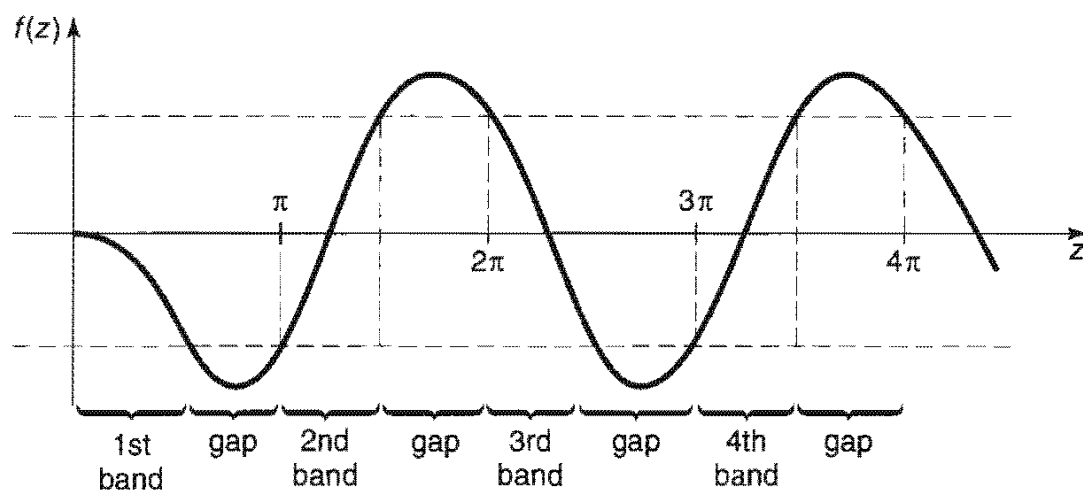

Figure 5.6: Graph of $f(z)$ (Equation 5.66) for $\beta = 1$, showing allowed bands separated by forbidden gaps.

and n can be any integer. You might imagine drawing N horizontal lines on Figure 5.6, at values of $\cos(2\pi n/N)$ ranging from $+1$ ($n = 0$) down to -1 ($n = N/2$), and back almost to $+1$ ($n = N - 1$)—at this point the Bloch factor e^{iKa} recycles, so no new solutions are generated by further increasing n . The intersection of each of these lines with $f(z)$ yields an allowed energy. Evidently there are $N/2$ positive-energy states in the first band (joined by $N/2$ negative-energy states) and N in all the higher bands; they are so closely spaced that for most purposes we can regard them as forming a continuum (Figure 5.7).

So far, we've only put *one* electron in our potential. In practice there will be Nq of them, where q is again the number of "free" electrons per atom. Because of

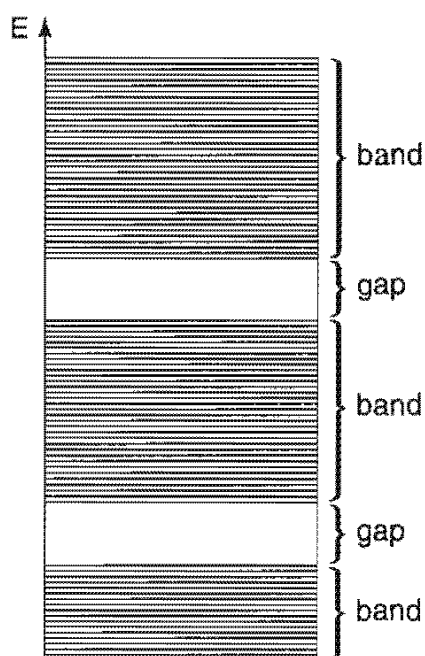

Figure 5.7: The allowed positive energies for a periodic potential.

the Pauli exclusion principle, only two electrons can occupy a given spatial state, so if $q = 1$, they will just fill the negative-energy half of the first band, if $q = 2$ they will completely fill the first band, if $q = 3$ they half fill the second band, and so on. (In three dimensions, and with more realistic potentials, the band structure may be more complicated, but the *existence* of bands, separated by forbidden gaps, persists—band structure is the *signature* of a periodic potential.) Now, if a band is entirely filled, it takes a relatively large energy to excite an electron, since it has to jump across the forbidden zone. Such materials will be electrical **insulators**. On the other hand, if a band is only *partly* filled, it takes very little energy to excite an electron, and such materials are typically **conductors**. If you **dope** an insulator with a few atoms of larger or smaller q , this puts some “extra” electrons into the next higher band, or creates some **holes** in the previously filled one, allowing in either case for weak electric currents to flow; such materials are called **semiconductors**. In the free electron model *all* solids should be excellent conductors, since there are no large gaps in the spectrum of allowed energies. It takes the band theory to account for the extraordinary range of electrical conductivities exhibited by the solids in nature.

Problem 5.15

- (a) Using Equations 5.59 and 5.63, show that the wave function for a particle in the periodic delta function potential can be written in the form

$$\psi(x) = C[\sin(kx) + e^{-iKa} \sin k(a - x)], \quad (0 \leq x \leq a).$$

(Don't bother to determine the normalization constant C .)

- (b) There is an exception: At the bottom of a band, where $ka = Ka = j\pi$, (a) yields $\psi(x) = 0$. Find the correct wave function for this case. Note what happens to ψ at each delta function.

Problem 5.16 Find the energy at the top of the first allowed band, for the case $\beta = 5$, correct to three significant digits. For the sake of argument, assume $\alpha/a = 1$ eV.

Problem 5.17 Suppose we used delta-function *spikes*, instead of *wells* (so that the electrons are *repelled*, instead of attracted, by the nuclei). Draw the analogs to Figures 5.6 and 5.7 (using the same values of the parameters—except for their signs). How many allowed energies are there in each band? What is the energy at the top of the j th band?

Problem 5.18 Show that *most* of the energies determined by Equation 5.64 are doubly degenerate. What are the exceptional cases? *Hint*: Try it for $N = 1, 2, 3, 4, \dots$, to see how it goes. What are the possible values of $\cos(Ka)$ in each case?

5.4 QUANTUM STATISTICAL MECHANICS

At absolute zero, a physical system occupies its lowest energy configuration. As we turn up the temperature, random thermal activity will begin to populate the excited states, and this raises the following question: If we have a large number N of particles in thermal equilibrium at temperature T , what is the probability that a given particle would be found to have a specific energy E_j ? Note that the “probability” in question has nothing to do with quantum indeterminacy—exactly the same question arises in *classical* statistical mechanics. The reason we must be content with a *probabilistic* answer is that we are typically dealing with enormous numbers of particles, and we could not possibly expect to keep track of each one separately, whether or *not* the underlying mechanics is deterministic.

The **fundamental assumption of statistical mechanics** is that in **thermal equilibrium** every distinct state with the same *total* energy E is equally probable. Random thermal motions constantly shift energy from one particle to another and from one form (rotational, kinetic, vibrational, etc.) to another, but (absent external influences) the *total* is fixed by conservation of energy. The assumption (and it’s a *deep* one, worth thinking about) is that this continual redistribution of energy does not favor any particular state. The **temperature** T is simply a measure of the total energy, for a system in thermal equilibrium. The only new twist introduced by quantum mechanics has to do with *how we count the distinct states*, and this depends critically on whether the particles involved are distinguishable, identical bosons, or identical fermions. The arguments are relatively straightforward, but the *arithmetic* gets pretty dense, so I’m going to begin with an absurdly simple example, so you’ll have a clear sense of what is at issue when we come to the general case.

5.4.1 Example

Suppose we have just *three* noninteracting particles (all of mass m) in the one-dimensional infinite square well (Section 2.2). The total energy is

$$E = E_A + E_B + E_C = \frac{\pi^2 \hbar^2}{2ma^2} (n_A^2 + n_B^2 + n_C^2) \quad [5.67]$$

(see Equation 2.23), where n_A , n_B , and n_C are positive integers. Now suppose, for the sake of argument, that $E = 243(\pi^2 \hbar^2 / 2ma^2)$, which is to say,

$$n_A^2 + n_B^2 + n_C^2 = 243. \quad [5.68]$$

There are, as it happens, 10 combinations of positive integers, the sum of whose squares is 243: All three could be 9, or two could be 3 and one 15 (which occurs in three permutations), or one could be 5, one 7, and one 13 (six permutations). Thus (n_A, n_B, n_C) is one of the following:

$$(9, 9, 9),$$

$$(3, 3, 15), (3, 15, 3), (15, 3, 3),$$

$$(5, 7, 13), (5, 13, 7), (7, 5, 13), (7, 13, 5), (13, 5, 7), (13, 7, 5).$$

If the particles are *distinguishable*, each of these represents a distinct quantum state, and the fundamental assumption of statistical mechanics says that in thermal equilibrium¹⁶ they are all equally likely. But I'm not interested in knowing *which* particle is in *which* (one-particle) state, only the total *number* of particles in each state—the **occupation number** N_n for the state ψ_n . The collection of all occupation numbers for a given three-particle state we will call the **configuration**. If all three are in ψ_9 , the configuration is

$$(0, 0, 0, 0, 0, 0, 0, 0, 0, 3, 0, 0, 0, 0, 0, 0, 0, 0, 0, 0, \dots) \quad [5.69]$$

(i.e., $N_9 = 3$, all others zero). If two are in ψ_3 and one is in ψ_{15} , the configuration is

$$(0, 0, 2, 0, 0, 0, 0, 0, 0, 0, 0, 0, 0, 0, 0, 0, 1, 0, 0, 0, \dots) \quad [5.70]$$

(i.e., $N_3 = 2$, $N_{15} = 1$, all others zero). And if there is one particle in ψ_5 , one in ψ_7 , and one in ψ_{13} , the configuration is

$$(0, 0, 0, 0, 0, 1, 0, 1, 0, 0, 0, 0, 0, 0, 1, 0, 0, 0, 0, 0, \dots) \quad [5.71]$$

(i.e., $N_5 = N_7 = N_{13} = 1$, all others zero.) Of these, the third is the *most probable* configuration, because it can be achieved in six different ways, whereas the second occurs three ways, and the first only one.

Returning now to my original question, if we select one of these three particles at random, what is the probability (P_n) of getting a specific (allowed) energy E_n ? Well, the chances are 1 in 10 that the system is in the first configuration (Equation 5.69), and in that event we are certain to get E_9 , so $P_9 = 1/10$. The chances are 3 in 10 that the system is in the second configuration (Equation 5.70), and in that case there is a 2/3 probability of getting E_3 , and 1/3 probability of getting E_{15} , so $P_3 = (3/10) \times (2/3) = 1/5$, and $P_{15} = (3/10) \times (1/3) = 1/10$. And the chances are 6 in 10 that the system is in the third configuration, in which case the probability is 1/3 each that we'll get E_5 , E_7 , and E_{13} , so $P_5 = P_7 = P_{13} = (6/10) \times (1/3) = 1/5$. As a check, we note that

¹⁶How the particles maintain thermal equilibrium, if they really don't interact at all, is a problem I'd rather not worry about—maybe God reaches in periodically and stirs things up (being careful not to add or remove any energy). In real life, of course, the continual redistribution of energy is caused precisely by interactions between the particles, so if you don't approve of divine intervention let there be extremely weak interactions—sufficient to thermalize the system (at least, over long time periods) but too small to alter the stationary states and the allowed energies appreciably.

$$P_3 + P_5 + P_7 + P_9 + P_{13} + P_{15} = \frac{1}{5} + \frac{1}{5} + \frac{1}{5} + \frac{1}{10} + \frac{1}{5} + \frac{1}{10} = 1.$$

But that's when the particles are distinguishable. If in fact they are *identical fermions*, the antisymmetrization requirement (leaving aside spin, for simplicity) excludes the first and second configurations (which assign two—or, worse still, three—particles into the same state), and there is just *one* state with the third configuration (see Problem 5.19). For identical fermions, then, $P_5 = P_7 = P_{13} = 1/3$ (and again the sum of the probabilities is 1). On the other hand, if they are *identical bosons* the symmetrization requirement allows for one state with each configuration (see Problem 5.19), so $P_9 = 1/3$, $P_3 = (1/3) \times (2/3) = 2/9$, $P_{15} = (1/3) \times (1/3) = 1/9$, and $P_5 = P_7 = P_{13} = (1/3) \times (1/3) = 1/9$. As always, the sum is 1.

The purpose of this example was to show you how the counting of states depends on the nature of the particles. In one respect it was actually *more complicated* than the realistic situation, in which N is a huge number. For as N grows, the most probable configuration (in this example, $N_5 = N_7 = N_{13} = 1$, for the case of distinguishable particles) becomes *overwhelmingly* more likely than its competitors, so that, for statistical purposes, we can afford to ignore the others altogether. *The distribution of individual particle energies, at equilibrium, is simply their distribution in the most probable configuration.* (If this were true for $N = 3$ —which, obviously, it is *not*—we would conclude that $P_5 = P_7 = P_{13} = 1/3$ for the case of distinguishable particles.) I'll return to this point in Section 5.4.3, but first we need to generalize the counting procedure itself.

*Problem 5.19

- (a) Construct the completely antisymmetric wave function $\psi(x_A, x_B, x_C)$ for three identical fermions, one in the state ψ_5 , one in the state ψ_7 , and one in the state ψ_{13} .
- (b) Construct the completely symmetric wave function $\psi(x_A, x_B, x_C)$ for three identical bosons, (i) if all three are in state ψ_9 , (ii) if two are in state ψ_3 and one is in state ψ_{13} , and (iii) if one is in state ψ_5 , one in state ψ_7 , and one in state ψ_{13} .

***Problem 5.20** Suppose you had three particles in a one-dimensional harmonic oscillator potential, in thermal equilibrium, with a total energy $E = (9/2)\hbar\omega$.

- (a) If they are distinguishable particles (but all with the same mass), what are the possible occupation-number configurations, and how many distinct (three-particle) states are there for each one? What is the most probable configuration? If you picked a particle at random and measured its energy, what values might you get, and what is the probability of each one? What is the most probable energy?

- (b) Do the same for the case of identical fermions (ignoring spin, as in the Example in Section 5.4.1).
- (c) Do the same for the case of identical bosons (ignoring spin).

5.4.2 The General Case

Now consider an arbitrary potential, for which the one-particle energies are E_1, E_2, E_3, \dots with degeneracies d_1, d_2, d_3, \dots (i.e., there are d_n distinct one-particle states with the same energy E_n). Suppose we put N particles (all with the same mass) into this potential; we are interested in the configuration (N_1, N_2, N_3, \dots) , for which there are N_1 particles with energy E_1 , N_2 particles with energy E_2 , and so on. *Question:* How many different ways can this be achieved (or, more precisely, how many distinct states correspond to this particular configuration)? The answer, $Q(N_1, N_2, N_3, \dots)$, depends on whether the particles are distinguishable, identical fermions, or identical bosons, so we'll treat the three cases separately.¹⁷

First, assume the particles are *distinguishable*. How many ways are there to select (from the N available candidates) the N_1 to be placed in the first "bin"? *Answer:* the **binomial coefficient**, " N choose N_1 ":

$$\binom{N}{N_1} \equiv \frac{N!}{N_1!(N - N_1)!} \tag{5.72}$$

For there are N ways to pick the first particle, leaving $(N - 1)$ for the second, and so on:

$$N(N - 1)(N - 2) \dots (N - N_1 + 1) = \frac{N!}{(N - N_1)!}$$

However, this counts separately the $N_1!$ different *permutations* of the N_1 particles, whereas we don't care whether number 37 was picked on the first draw, or on the twenty-ninth draw; so we divide by $N_1!$, confirming Equation 5.72. Now, how many different ways can those N_1 particles be arranged *within* the first bin? Well, there are d_1 states in the bin, so each particle has d_1 choices; evidently there are $(d_1)^{N_1}$ possibilities in all. Thus the number of ways to put N_1 particles, selected from a total population of N , into a bin containing d_1 distinct options, is

$$\frac{N! d_1^{N_1}}{N_1!(N - N_1)!}$$

The same goes for bin 2, of course, except that there are now only $(N - N_1)$ particles left to work with:

$$\frac{(N - N_1)! d_2^{N_2}}{N_2!(N - N_1 - N_2)!}$$

¹⁷The presentation here follows closely that of Amnon Yariv, *An Introduction to Theory and Applications of Quantum Mechanics* (New York: John Wiley & Sons, 1982).

and so on. It follows that

$$\begin{aligned}
 & Q(N_1, N_2, N_3, \dots) \\
 &= \frac{N!d_1^{N_1}}{N_1!(N - N_1)!} \frac{(N - N_1)!d_2^{N_2}}{N_2!(N - N_1 - N_2)!} \frac{(N - N_1 - N_2)!d_3^{N_3}}{N_3!(N - N_1 - N_2 - N_3)!} \dots \\
 &= N! \frac{d_1^{N_1} d_2^{N_2} d_3^{N_3} \dots}{N_1! N_2! N_3! \dots} = N! \prod_{n=1}^{\infty} \frac{d_n^{N_n}}{N_n!}. \tag{5.73}
 \end{aligned}$$

(You should pause right now and *check* this result for the Example in Section 5.4.1—see Problem 5.21.)

The problem is a lot easier for *identical fermions*. Because they are indistinguishable, it doesn't matter *which* particles are in *which* states—the antisymmetrization requirement means that there is just *one* N -particle state in which a specific set of one-particle states is occupied. Moreover, only one particle can occupy any given state. There are

$$\binom{d_n}{N_n}$$

ways to choose the N_n occupied states in the n th bin,¹⁸ so

$$Q(N_1, N_2, N_3, \dots) = \prod_{n=1}^{\infty} \frac{d_n!}{N_n!(d_n - N_n)!}. \tag{5.74}$$

(Check it for the Example in Section 5.4.1—see Problem 5.21.)

The calculation is hardest for the case of *identical bosons*. Again, the symmetrization requirement means that there is just one N -particle state in which a specific set of one-particle states is occupied, but this time there is no restriction on the number of particles that can share the same one-particle state. For the n th bin, the question becomes: how many different ways can we assign N_n identical particles to d_n different slots? There are many ways to solve this combinatorial problem: an especially clever method involves the following trick: Let dots represent particles and crosses represent partitions, so that, for example, if $d_n = 5$ and $N_n = 7$,

$$\bullet \bullet \times \bullet \times \bullet \bullet \bullet \times \bullet \times$$

would indicate that there are two particles in the first state, one in the second, three in the third, one in the fourth, and none in the fifth. Note that there are N_n dots and $(d_n - 1)$ crosses (partitioning the dots into d_n groups). If the individual dots and crosses were *labeled*, there would be $(N_n + d_n - 1)!$ different ways to arrange them. But for our purposes the dots are all equivalent—permuting them ($N_n!$ ways) does not

¹⁸This should be zero, of course, if $N_n > d_n$, and it *is*, provided that we consider the factorial of a negative integer to be infinite.

change the state. Likewise, the crosses are all equivalent—permuting them $[(d_n - 1)!]$ ways] changes nothing. So there are in fact

$$\frac{(N_n + d_n - 1)!}{N_n!(d_n - 1)!} = \binom{N_n + d_n - 1}{N_n} \quad [5.75]$$

distinct ways of assigning the N_n particles to the d_n one-particle states in the n th bin, and we conclude that

$$Q(N_1, N_2, N_3, \dots) = \prod_{n=1}^{\infty} \frac{(N_n + d_n - 1)!}{N_n!(d_n - 1)!}. \quad [5.76]$$

(Check it for the Example in Section 5.4.1—see Problem 5.21.)

***Problem 5.21** Check Equations 5.73, 5.74, and 5.76 for the Example in Section 5.4.1.

****Problem 5.22** Obtain Equation 5.75 by induction. The combinatorial question is this: How many different ways can you put N identical balls into d baskets (never mind the subscript n for this problem). You could stick all N of them into the third basket, or all but one in the second basket and one in the fifth, or two in the first and three in the third and all the rest in the seventh, etc. Work it out explicitly for the cases $N = 1$, $N = 2$, $N = 3$, and $N = 4$; by that stage you should be able to deduce the general formula.

5.4.3 The Most Probable Configuration

In thermal equilibrium, every state with a given total energy E and a given particle number N is equally likely. So the *most probable configuration* (N_1, N_2, N_3, \dots) is the one that can be achieved in the largest number of different ways—it is that particular configuration for which $Q(N_1, N_2, N_3, \dots)$ is a maximum, subject to the constraints

$$\sum_{n=1}^{\infty} N_n = N \quad [5.77]$$

and

$$\sum_{n=1}^{\infty} N_n E_n = E. \quad [5.78]$$

The problem of maximizing a function $F(x_1, x_2, x_3, \dots)$ of several variables, subject to the constraints $f_1(x_1, x_2, x_3, \dots) = 0$, $f_2(x_1, x_2, x_3, \dots) = 0$, etc., is most conveniently handled by the method of **Lagrange multipliers**¹⁹: We introduce the new function

¹⁹See, for example, Mary Boas, *Mathematical Methods in the Physical Sciences*, 2nd ed. (New York: John Wiley & Sons, 1983), Chapter 4, Section 9.

$$G(x_1, x_2, x_3, \dots, \lambda_1, \lambda_2, \dots) \equiv F + \lambda_1 f_1 + \lambda_2 f_2 + \dots \quad [5.79]$$

and set *all* its derivatives equal to zero:

$$\frac{\partial G}{\partial x_n} = 0; \quad \frac{\partial G}{\partial \lambda_n} = 0. \quad [5.80]$$

In our case it's a little easier to work with the *logarithm* of Q , instead of Q itself—this turns the *products* into *sums*. Since the logarithm is a monotonic function of its argument, the maxima of Q and $\ln(Q)$ occur at the same point. So we let

$$G \equiv \ln(Q) + \alpha \left[N - \sum_{n=1}^{\infty} N_n \right] + \beta \left[E - \sum_{n=1}^{\infty} N_n E_n \right], \quad [5.81]$$

where α and β are the Lagrange multipliers. Setting the derivatives with respect to α and β equal to zero merely reproduces the constraints (Equations 5.77 and 5.78): it remains, then, to set the derivative with respect to N_n equal to zero.

If the particles are *distinguishable*, then Q is given by Equation 5.73, and we have

$$G = \ln(N!) + \sum_{n=1}^{\infty} [N_n \ln(d_n) - \ln(N_n!)] \\ + \alpha \left[N - \sum_{n=1}^{\infty} N_n \right] + \beta \left[E - \sum_{n=1}^{\infty} N_n E_n \right]. \quad [5.82]$$

Assuming that the relevant occupation numbers (N_n) are large, we can invoke **Stirling's approximation**²⁰:

$$\ln(z!) \approx z \ln(z) - z \quad \text{for } z \gg 1 \quad [5.83]$$

to write

$$G \approx \sum_{n=1}^{\infty} [N_n \ln(d_n) - N_n \ln(N_n) + N_n - \alpha N_n - \beta E_n N_n] \\ + \ln(N!) + \alpha N + \beta E. \quad [5.84]$$

It follows that

$$\frac{\partial G}{\partial N_n} = \ln(d_n) - \ln(N_n) - \alpha - \beta E_n. \quad [5.85]$$

²⁰See George Arfken, *Mathematical Methods for Physicists*, 3rd ed. (Orlando, FL: Academic Press, 1985), Section 10.3. If the relevant occupation numbers are *not* large—as in the Example of Section 5.4.1—then statistical mechanics simply doesn't apply. The whole point is to deal with such enormous numbers that statistical inference is a reliable predictor. Of course, there will always be one-particle states of extremely high energy that are not populated at *all*; fortunately, Stirling's approximation holds also for $z = 0$. I use the word "relevant" to exclude any stray states right at the margin, for which N_n is neither huge nor zero.

Setting this equal to zero and solving for N_n , we conclude that the *most probable occupation numbers* for distinguishable particles are

$$N_n = d_n e^{-(\alpha + \beta E_n)}. \quad [5.86]$$

If the particles are *identical fermions*, then Q is given by Equation 5.74, and we have

$$\begin{aligned} G = & \sum_{n=1}^{\infty} \{ \ln(d_n!) - \ln(N_n!) - \ln[(d_n - N_n)!] \} \\ & + \alpha \left[N - \sum_{n=1}^{\infty} N_n \right] + \beta \left[E - \sum_{n=1}^{\infty} N_n E_n \right]. \end{aligned} \quad [5.87]$$

This time we must assume not only that N_n is large, but also that $d_n \gg N_n$,²¹ so that Stirling's approximation applies to both terms. In that case

$$\begin{aligned} G \approx & \sum_{n=1}^{\infty} \left[\ln(d_n!) - N_n \ln(N_n) + N_n - (d_n - N_n) \ln(d_n - N_n) \right. \\ & \left. + (d_n - N_n) - \alpha N_n - \beta E_n N_n \right] + \alpha N + \beta E, \end{aligned} \quad [5.88]$$

so

$$\frac{\partial G}{\partial N_n} = -\ln(N_n) + \ln(d_n - N_n) - \alpha - \beta E_n. \quad [5.89]$$

Setting this equal to zero and solving for N_n , we find the *most probable occupation numbers* for identical fermions:

$$N_n = \frac{d_n}{e^{(\alpha + \beta E_n)} + 1}. \quad [5.90]$$

Finally, if the particles are *identical bosons*, then Q is given by Equation 5.76, and we have

$$\begin{aligned} G = & \sum_{n=1}^{\infty} \{ \ln[(N_n + d_n - 1)!] - \ln(N_n!) - \ln[(d_n - 1)!] \} \\ & + \alpha \left[N - \sum_{n=1}^{\infty} N_n \right] + \beta \left[E - \sum_{n=1}^{\infty} N_n E_n \right]. \end{aligned} \quad [5.91]$$

²¹In *one* dimension the energies are nondegenerate (see Problem 2.42), but in three dimensions d_n typically increases rapidly with increasing n (for example, in the case of hydrogen, $d_n = n^2$). So it is not unreasonable to assume that for *most* of the occupied states $d_n \gg 1$. On the other hand, d_n is certainly *not* much greater than N_n at absolute zero, where all states up to the Fermi level are filled, and hence $d_n = N_n$. Here again we are rescued by the fact that Stirling's formula holds also for $z = 0$.

Assuming (as always) that $N_n \gg 1$, and using Stirling's approximation:

$$G \approx \sum_{n=1}^{\infty} \left\{ (N_n + d_n - 1) \ln(N_n + d_n - 1) - (N_n + d_n - 1) - N_n \ln(N_n) \right. \\ \left. + N_n - \ln[(d_n - 1)!] - \alpha N_n - \beta E_n N_n \right\} + \alpha N + \beta E, \quad [5.92]$$

so

$$\frac{\partial G}{\partial N_n} = \ln(N_n + d_n - 1) - \ln(N_n) - \alpha - \beta E_n. \quad [5.93]$$

Setting this equal to zero and solving for N_n , we find the *most probable occupation numbers* for identical bosons:

$$N_n = \frac{d_n - 1}{e^{(\alpha + \beta E_n)} - 1}. \quad [5.94]$$

(For consistency with the approximations already invoked, we should really drop the 1 in the numerator, and I shall do so from now on.)

Problem 5.23 Use the method of Lagrange multipliers to find the area of the largest rectangle, with sides parallel to the axes, that can be inscribed in the ellipse $(x/a)^2 + (y/b)^2 = 1$.

Problem 5.24

- (a) Find the percent error in Stirling's approximation for $z = 10$.
 - (b) What is the smallest integer z such that the error is less than 1%?
-

5.4.4 Physical Significance of α and β

The parameters α and β came into the story as Lagrange multipliers, associated with the total number of particles and the total energy, respectively. Mathematically, they are determined by substituting the occupation numbers (Equations 5.86, 5.90, and 5.94) back into the constraint equations (Equations 5.77 and 5.78). To carry out the summation, however, we need to know the allowed energies (E_n) and their degeneracies (d_n) for the potential in question. As an example, I'll work out the case of a three-dimensional infinite square well; this will enable us to infer the physical significance of α and β .

In Section 5.3.1 we determined the the allowed energies (Equation 5.39):

$$E_k = \frac{\hbar^2}{2m} k^2, \quad [5.95]$$

where

$$\mathbf{k} = \left(\frac{\pi n_x}{l_x}, \frac{\pi n_y}{l_y}, \frac{\pi n_z}{l_z} \right).$$

As before, we convert the sum into an integral, treating \mathbf{k} as a continuous variable, with one state (or, for spin s , $2s + 1$ states) per volume π^3/V of k -space. Taking as our “bins” the spherical shells in the first octant (see Figure 5.4), the “degeneracy” (that is, the number of states in the bin) is

$$d_k = \frac{1}{8} \frac{4\pi k^2 dk}{(\pi^3/V)} = \frac{V}{2\pi^2} k^2 dk. \quad [5.96]$$

For distinguishable particles (Equation 5.86), the first constraint (Equation 5.77) becomes

$$N = \frac{V}{2\pi^2} e^{-\alpha} \int_0^\infty e^{-\beta \hbar^2 k^2 / 2m} k^2 dk = V e^{-\alpha} \left(\frac{m}{2\pi \beta \hbar^2} \right)^{3/2},$$

so

$$e^{-\alpha} = \frac{N}{V} \left(\frac{2\pi \beta \hbar^2}{m} \right)^{3/2}. \quad [5.97]$$

The second constraint (Equation 5.78) says

$$E = \frac{V}{2\pi^2} e^{-\alpha} \frac{\hbar^2}{2m} \int_0^\infty e^{-\beta \hbar^2 k^2 / 2m} k^4 dk = \frac{3V}{2\beta} e^{-\alpha} \left(\frac{m}{2\pi \beta \hbar^2} \right)^{3/2},$$

or, putting in Equation 5.97 for $e^{-\alpha}$,

$$E = \frac{3N}{2\beta}. \quad [5.98]$$

(If you include the spin factor, $2s + 1$, in Equation 5.96, it cancels out at this point, so Equation 5.98 is correct regardless of spin.)

Equation 5.98 is reminiscent of the classical formula for the average kinetic energy of an atom at temperature T ²²:

$$\frac{E}{N} = \frac{3}{2} k_B T, \quad [5.99]$$

where k_B is the Boltzmann constant. This suggests that β is related to the *temperature*:

$$\beta = \frac{1}{k_B T}. \quad [5.100]$$

²²See, for example, David Halliday and Robert Resnick, *Fundamentals of Physics*, 3rd ed. extended (New York: John Wiley & Sons, 1988), Section 21-5.

To prove that this holds in general, and not simply for distinguishable particles in the three-dimensional infinite square well, we would have to demonstrate that different substances in thermal equilibrium with one another have the same value of β . The argument is sketched in many books,²³ but I shall not reproduce it here—I will simply adopt equation [5.100] as the *definition* of T .

It is customary to replace α (which, as is clear from the special case of Equation 5.97, is a function of T) by the so-called **chemical potential**,

$$\mu(T) \equiv -\alpha k_B T, \quad [5.101]$$

and rewrite Equations 5.86, 5.90, and 5.94 as formulas for the *most probable number of particles in a particular (one-particle) state with energy ϵ* (to go from the number of particles with a given energy to the number of particles in a particular *state* with that energy, we simply divide by the degeneracy of the state):

$$n(\epsilon) = \begin{cases} e^{-(\epsilon-\mu)/k_B T}, & \text{MAXWELL-BOLTZMANN} \\ \frac{1}{e^{(\epsilon-\mu)/k_B T} + 1}, & \text{FERMI-DIRAC} \\ \frac{1}{e^{(\epsilon-\mu)/k_B T} - 1}, & \text{BOSE-EINSTEIN} \end{cases} \quad [5.102]$$

The **Maxwell-Boltzmann distribution** is the classical result for *distinguishable* particles; the **Fermi-Dirac distribution** applies to *identical fermions*, and the **Bose-Einstein distribution** is for *identical bosons*.

The Fermi-Dirac distribution has a particularly simple behavior as $T \rightarrow 0$:

$$e^{(\epsilon-\mu)/k_B T} \rightarrow \begin{cases} 0, & \text{if } \epsilon < \mu(0), \\ \infty, & \text{if } \epsilon > \mu(0), \end{cases}$$

so

$$n(\epsilon) \rightarrow \begin{cases} 1, & \text{if } \epsilon < \mu(0), \\ 0, & \text{if } \epsilon > \mu(0). \end{cases} \quad [5.103]$$

All states are filled, up to an energy $\mu(0)$, and none are occupied for energies above this (Figure 5.8). Evidently the chemical potential at absolute zero is precisely the Fermi energy:

$$\mu(0) = E_F. \quad [5.104]$$

As the temperature rises, the Fermi-Dirac distribution “softens” the cutoff, as indicated by the rounded curve in Figure 5.8.

For distinguishable particles in the three-dimensional infinite square well, we found (Equation 5.98) that the total energy at temperature T is

$$E = \frac{3}{2} N k_B T; \quad [5.105]$$

²³See, for example, Yariv, footnote 17, Section 15.4.

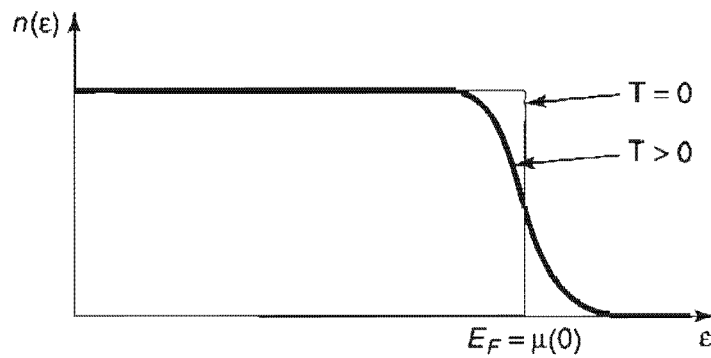

Figure 5.8: Fermi-Dirac distribution for $T = 0$ and for T somewhat above zero.

from Equation 5.97 it follows that

$$\mu(T) = k_B T \left[\ln \left(\frac{N}{V} \right) + \frac{3}{2} \ln \left(\frac{m k_B T}{3\pi \hbar^2} \right) \right]. \quad [5.106]$$

I would like to work out the corresponding formulas for identical fermions and bosons, using Equations 5.90 and 5.94 in place of Equation 5.86. The first constraint (Equation 5.77) becomes

$$N = \frac{V}{2\pi^2} \int_0^\infty \frac{k^2}{e^{(\hbar^2 k^2/2m) - \mu/k_B T} \pm 1} dk \quad [5.107]$$

(with the plus sign for fermions and minus for bosons), and the second constraint (Equation 5.78) reads

$$E = \frac{V}{2\pi^2} \frac{\hbar^2}{2m} \int_0^\infty \frac{k^4}{e^{(\hbar^2 k^2/2m) - \mu/k_B T} \pm 1} dk. \quad [5.108]$$

The first of these determines $\mu(T)$, and the second determines $E(T)$ (from the latter we obtain, for instance, the heat capacity $C = \partial E / \partial T$). Unfortunately, the integrals cannot be evaluated in terms of elementary functions, and I shall leave it for you to explore the matter further (see Problems 5.25 and 5.26).

Problem 5.25 Evaluate the integrals (Equations 5.107 and 5.108) for the case of identical fermions at absolute zero. Compare your results with Equations 5.43 and 5.45. (Note that for electrons there is an extra factor of 2 in Equations 5.107 and 5.108, to account for the spin degeneracy.)

*****Problem 5.26**

- (a) Show that for bosons the chemical potential must always be less than the minimum allowed energy. *Hint:* $n(\epsilon)$ cannot be negative.
- (b) In particular, for the ideal Bose gas (identical bosons in the three-dimensional infinite square well), $\mu(T) < 0$ for all T . Show that in this case $\mu(T)$ monotonically increases as T decreases, assuming that N and V are held constant. *Hint:* Study Equation 5.107, with the minus sign.

- (c) A crisis (called **bose condensation**) occurs when (as we lower T) $\mu(T)$ hits zero. Evaluate the integral, for $\mu = 0$, and obtain the formula for the critical temperature T_c at which this happens. *Note:* Below the critical temperature, the particles crowd into the ground state, and the calculational device of replacing the discrete sum (Equation 5.77) by a continuous integral (Equation 5.107) loses its validity. See F. Mandl, *Statistical Physics* (London: John Wiley & Sons, 1971), Section 11.5. *Hint:*

$$\int_0^{\infty} \frac{x^{s-1}}{e^x - 1} dx = \Gamma(s)\zeta(s), \quad [5.108]$$

where Γ is Euler's **gamma function** and ζ is the **Riemann zeta function**. Look up the appropriate numerical values.

- (d) Find the critical temperature for ${}^4\text{He}$. Its density, at this temperature, is 0.15 gm/cm^3 . *Note:* The experimental value of the critical temperature in ${}^4\text{He}$ is 2.17 K . The remarkable properties of ${}^4\text{He}$ in the neighborhood of T_c are discussed in the reference cited in (c).

5.4.5 The Blackbody Spectrum

Photons (quanta of the electromagnetic field) are identical bosons with spin 1, but they are a very special case because they are *massless* particles, and hence intrinsically relativistic. We can include them here, if you are prepared to accept four assertions that do not really belong to nonrelativistic quantum mechanics:

- (1) The energy of a photon is related to its frequency by the Planck formula $E = h\nu = \hbar\omega$.
- (2) The wave number k is related to the frequency by $k = 2\pi/\lambda = \omega/c$, where c is the speed of light.
- (3) Only two spin states occur (the quantum number m can be $+1$ or -1 , but not 0).
- (4) The *number* of photons is not a conserved quantity; when the temperature rises the number of photons (per unit volume) increases.

In view of item 4, the first constraint equation (Equation 5.77) does not apply. We can take account of this by simply setting $\alpha \rightarrow 0$, in Equation 5.81 and everything that follows. Thus the most probable occupation number for photons is (Equation 5.94)

$$N_{\omega} = \frac{d_k}{e^{\hbar\omega/k_B T} - 1}. \quad [5.110]$$

For free photons in a box of volume V , d_k is given by Equation 5.96,²⁴ multiplied by 2 for spin (item 3), and expressed in terms of ω instead of k (item 2):

²⁴In truth, we have no business using this formula, which came from the (nonrelativistic) Schrödinger equation; fortunately, the degeneracy is exactly the same for the relativistic case. See Problem 5.3.2.

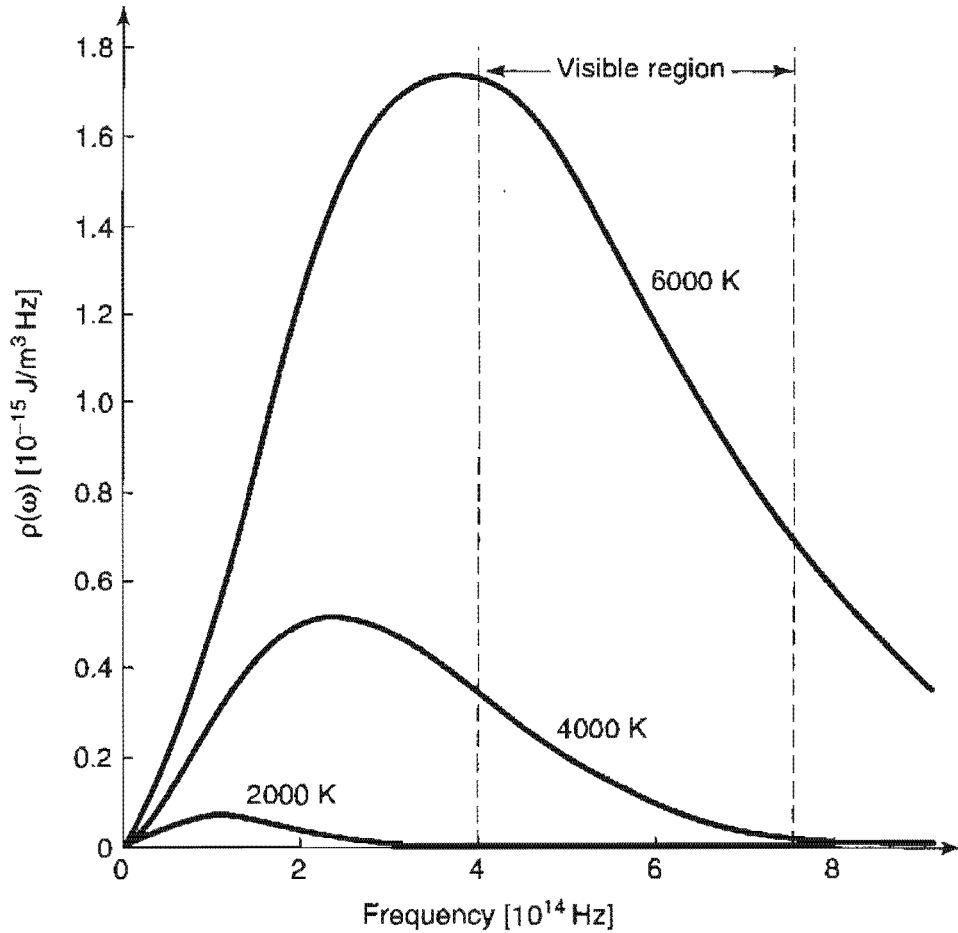

Figure 5.9: Planck's formula for the blackbody spectrum, Equation 5.112.

$$d_k = \frac{V}{\pi^2 c^3} \omega^2 d\omega. \quad [5.111]$$

So the energy density $N_\omega \hbar \omega / V$, in the frequency range $d\omega$, is $\rho(\omega) d\omega$, where

$$\rho(\omega) = \frac{\hbar \omega^3}{\pi^2 c^3 (e^{\hbar \omega / k_B T} - 1)}. \quad [5.112]$$

This is Planck's famous **blackbody spectrum**, giving the energy per unit volume, per unit frequency, in an electromagnetic field at equilibrium at temperature T . It is plotted, for three different temperatures, in Figure 5.9.

Problem 5.27 Use Equation 5.112 to determine the energy density in the *wavelength* range $d\lambda$. *Hint:* set $\rho(\omega)d\omega = \bar{\rho}(\lambda)d\lambda$, and solve for $\bar{\rho}(\lambda)$. Derive the **Wien displacement law** for the wavelength at which the blackbody energy density is a maximum:

$$\lambda_{\max} = \frac{2.90 \times 10^{-3} \text{ mK}}{T}. \quad [5.113]$$

You'll need to solve the transcendental equation $(5 - x) = 5e^{-x}$, using a calculator (or a computer); get the numerical answer accurate to three significant digits.

Problem 5.28 Derive the **Stefan-Boltzmann formula** for the total energy density in blackbody radiation:

$$\frac{E}{V} = \left(\frac{\pi^2 k_B^4}{15 \hbar^3 c^3} \right) T^4 = (7.57 \times 10^{-16} \text{ Jm}^{-3}\text{K}^{-4}) T^4. \quad [5.114]$$

Hint: Use the hint in Problem 5.26(c) to evaluate the integral. Note that $\zeta(4) = \pi^4/90$.

FURTHER PROBLEMS FOR CHAPTER 5

Problem 5.29 Suppose you have three particles, and three distinct one-particle states ($\psi_a(x)$, $\psi_b(x)$, and $\psi_c(x)$) are available. How many different three-particle states can be constructed (a) if they are distinguishable particles, (b) if they are identical bosons, and (c) if they are identical fermions? [The particles need not be in *different* states— $\psi_a(x_1)\psi_a(x_2)\psi_a(x_3)$ would be one possibility if the particles are distinguishable.]

Problem 5.30 Calculate the Fermi energy for electrons in a *two*-dimensional infinite square well. (Let σ be the number of free electrons per unit area.)

*****Problem 5.31** Certain cold stars (called **white dwarfs**) are stabilized against gravitational collapse by the degeneracy pressure of their electrons (Equation 5.46). Assuming constant density, the radius R of such an object can be calculated as follows:

- Write the total electron energy (Equation 5.45) in terms of the radius, the number of nucleons (protons and neutrons) N , the number of electrons per nucleon q , and the mass of the electron m .
- Look up, or calculate, the gravitational energy of a uniformly dense sphere. Express your answer in terms of G (the constant of universal gravitation), R , N , and M (the mass of a nucleon). Note that the gravitational energy is *negative*.
- Find the radius for which the total energy, (a) plus (b), is a minimum. *Answer:*

$$R = \left(\frac{9\pi}{4} \right)^{2/3} \frac{\hbar^2 q^{5/3}}{GmM^2 N^{1/3}}.$$

(Note that the radius *decreases* as the total mass *increases*!) Put in the actual numbers, for everything except N , using $q = 1/2$ (actually, q decreases a bit as the atomic number increases, but this is close enough for our purposes). *Answer:* $R = 7.6 \times 10^{25} N^{-1/3}$.

- Determine the radius, in kilometers, of a white dwarf with the mass of the sun.
- Determine the Fermi energy, in electron volts, for the white dwarf in (d), and compare it with the rest energy of an electron. Note that this system is getting dangerously relativistic (see Problem 5.32).

*****Problem 5.32** We can extend the theory of a free electron gas (Section 5.3.1) to the relativistic domain by replacing the classical kinetic energy, $E = p^2/2m$, with the relativistic formula, $E = \sqrt{p^2 c^2 + m^2 c^4} - mc^2$. Momentum is related to the

wave vector in the usual way: $\mathbf{p} = \hbar\mathbf{k}$. In particular, in the *extreme* relativistic limit, $E \approx pc = \hbar ck$.

- (a) Replace $\hbar^2 k^2/2m$ in Equation 5.44 by the ultrarelativistic expression, $\hbar ck$, and calculate E_{tot} in this regime.
- (b) Repeat parts (a) and (b) of Problem 5.31 for the ultrarelativistic electron gas. Notice that in this case there is *no* stable minimum, regardless of R ; if the total energy is positive, degeneracy forces exceed gravitational forces and the star will expand, whereas if the total is negative, gravitational forces win out and the star will collapse. Find the critical number of nucleons N_c such that gravitational collapse occurs for $N > N_c$. This is called the **Chandrasekhar limit**. *Answer:* 2.0×10^{57} . What is the corresponding stellar mass (give your answer as a multiple of the sun's mass). Stars heavier than this will not form white dwarfs, but collapse further, becoming (if conditions are right) **neutron stars**.
- (c) At extremely high density, **inverse beta decay**, $e^- + p^+ \rightarrow n + \nu$, converts virtually all of the protons and electrons into neutrons (liberating neutrinos, which carry off energy, in the process). Eventually *neutron* degeneracy pressure stabilizes the collapse, just as *electron* degeneracy does for the white dwarf (see Problem 5.31). Calculate the radius of a neutron star with the mass of the sun. Also calculate the (neutron) Fermi energy, and compare it to the rest energy of a neutron. Is it reasonable to treat such a star nonrelativistically?

*****Problem 5.33**

- (a) Find the chemical potential and the total energy for distinguishable particles in the three-dimensional harmonic oscillator potential (Problem 4.39). *Hint:* The sums in Equations 5.77 and 5.78 can be evaluated exactly in this case—no need to use an integral approximation, as we did for the infinite square well. Note that by differentiating the geometric series,

$$\frac{1}{1-x} = \sum_{n=0}^{\infty} x^n, \quad [5.115]$$

you can get

$$\frac{d}{dx} \left(\frac{x}{1-x} \right) = \sum_{n=0}^{\infty} (n+1)x^n$$

and similar results for higher derivatives. *Answer:*

$$E = \frac{3}{2} N \hbar \omega \left(\frac{1 + e^{-\hbar\omega/k_B T}}{1 - e^{-\hbar\omega/k_B T}} \right). \quad [5.116]$$

- (b) Discuss the limiting case $k_B T \ll \hbar\omega$.
- (c) Discuss the classical limit, $k_B T \gg \hbar\omega$, in the light of the **equipartition theorem** (see, for example, Halliday and Resnick, footnote 22, Section 21-9). How many **degrees of freedom** does a particle in the three-dimensional harmonic oscillator possess?

PART II

APPLICATIONS

CHAPTER 6

TIME-INDEPENDENT PERTURBATION THEORY

6.1 NONDEGENERATE PERTURBATION THEORY

6.1.1 General Formulation

Suppose we have solved the (time-independent) Schrödinger equation for some potential (say, the one-dimensional infinite square well):

$$H^0 \psi_n^0 = E_n^0 \psi_n^0, \quad [6.1]$$

obtaining a complete set of orthonormal eigenfunctions, ψ_n^0 ,

$$\langle \psi_n^0 | \psi_m^0 \rangle = \delta_{nm}, \quad [6.2]$$

and the corresponding eigenvalues E_n^0 . Now we perturb the potential slightly (say, by putting a little bump in the bottom of the well—Figure 6.1). We'd *like* to solve for the new eigenfunctions and eigenvalues:

$$H \psi_n = E_n \psi_n, \quad [6.3]$$

but unless we are very lucky, we're unlikely to be able to solve the Schrödinger equation exactly, for this more complicated potential. **Perturbation theory** is a systematic procedure for obtaining *approximate* solutions to the perturbed problem by building on the known exact solutions to the *unperturbed* case.

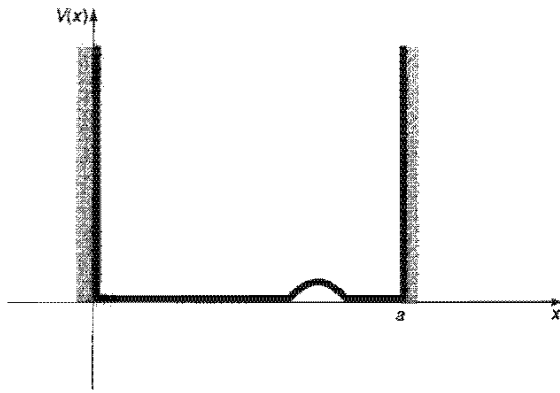

Figure 6.1: Infinite square well with small perturbation.

To begin with, we write the new Hamiltonian as the sum of two terms:

$$H = H^0 + \lambda H', \quad [6.4]$$

where H' is the perturbation. For the moment we'll take λ to be a small number; later we'll crank it up to 1, and H will be the true, exact Hamiltonian. Writing ψ_n and E_n as power series in λ , we have

$$\psi_n = \psi_n^0 + \lambda \psi_n^1 + \lambda^2 \psi_n^2 + \dots; \quad [6.5]$$

$$E_n = E_n^0 + \lambda E_n^1 + \lambda^2 E_n^2 + \dots. \quad [6.6]$$

Here E_n^1 is the **first-order correction** to the n^{th} eigenvalue, and ψ_n^1 is the first-order correction to the n^{th} eigenfunction; E_n^2 and ψ_n^2 are the **second-order corrections**, and so on. Plugging Equations 6.4, 6.5, and 6.6 into Equation 6.3, we have

$$\begin{aligned} & (H^0 + \lambda H')[\psi_n^0 + \lambda \psi_n^1 + \lambda^2 \psi_n^2 + \dots] \\ &= (E_n^0 + \lambda E_n^1 + \lambda^2 E_n^2 + \dots)[\psi_n^0 + \lambda \psi_n^1 + \lambda^2 \psi_n^2 + \dots], \end{aligned}$$

or (collecting like powers of λ):

$$\begin{aligned} & H^0 \psi_n^0 + \lambda(H^0 \psi_n^1 + H' \psi_n^0) + \lambda^2(H^0 \psi_n^2 + H' \psi_n^1) + \dots \\ &= E_n^0 \psi_n^0 + \lambda(E_n^0 \psi_n^1 + E_n^1 \psi_n^0) + \lambda^2(E_n^0 \psi_n^2 + E_n^1 \psi_n^1 + E_n^2 \psi_n^0) + \dots. \end{aligned}$$

To lowest order (λ^0) this yields $H^0 \psi_n^0 = E_n^0 \psi_n^0$, which is nothing new (just Equation 6.1). To first order (λ^1),

$$H^0 \psi_n^1 + H' \psi_n^0 = E_n^0 \psi_n^1 + E_n^1 \psi_n^0. \quad [6.7]$$

To second order (λ^2),

$$H^0 \psi_n^2 + H' \psi_n^1 = E_n^0 \psi_n^2 + E_n^1 \psi_n^1 + E_n^2 \psi_n^0, \quad [6.8]$$

and so on. (I'm done with λ , now—it was just a device to keep track of the different orders—so crank it up to 1.)

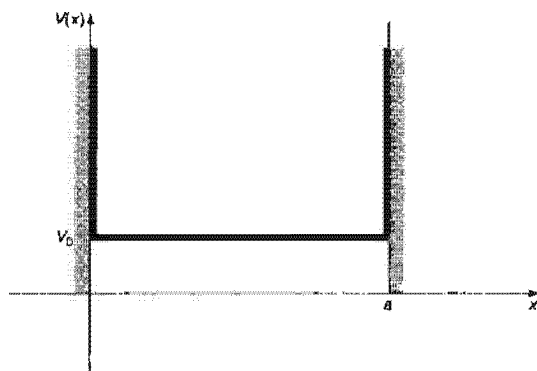

Figure 6.2: Constant perturbation over the whole well.

6.1.2 First-Order Theory

Taking the inner product of Equation 6.7 with ψ_n^0 [that is, multiplying by $(\psi_n^0)^*$ and integrating],

$$\langle \psi_n^0 | H^0 \psi_n^1 \rangle + \langle \psi_n^0 | H' \psi_n^0 \rangle = E_n^0 \langle \psi_n^0 | \psi_n^1 \rangle + E_n^1 \langle \psi_n^0 | \psi_n^0 \rangle.$$

But H^0 is Hermitian, so

$$\langle \psi_n^0 | H^0 \psi_n^1 \rangle = \langle H^0 \psi_n^0 | \psi_n^1 \rangle = \langle E_n^0 \psi_n^0 | \psi_n^1 \rangle = E_n^0 \langle \psi_n^0 | \psi_n^1 \rangle,$$

and this cancels the first term on the right. Moreover, $\langle \psi_n^0 | \psi_n^0 \rangle = 1$, so¹

$$E_n^1 = \langle \psi_n^0 | H' | \psi_n^0 \rangle. \quad [6.9]$$

This is the fundamental result of first-order perturbation theory; as a *practical* matter, it may well be the most important equation in quantum mechanics. It says that the first-order correction to the energy is the *expectation value* of the perturbation in the *unperturbed* state.

Example. The unperturbed wave functions for the infinite square well are (Equation 2.24)

$$\psi_n^0(x) = \sqrt{\frac{2}{a}} \sin\left(\frac{n\pi}{a}x\right).$$

Suppose first that we perturb the system by simply raising the “floor” of the well by a constant amount V_0 (Figure 6.2). In that case $H' = V_0$, and the first-order correction to the energy of the n^{th} state is

$$E_n^1 = \langle \psi_n^0 | V_0 | \psi_n^0 \rangle = V_0 \langle \psi_n^0 | \psi_n^0 \rangle = V_0.$$

¹In this context it doesn't matter whether we write $\langle \psi_n^0 | H' | \psi_n^0 \rangle$ or $\langle \psi_n^0 | H' | \psi_n^0 \rangle$ (with the extra vertical bar) because we are using the wave function itself to “label” the state. But the latter notation is preferable because it frees us from this specific convention.

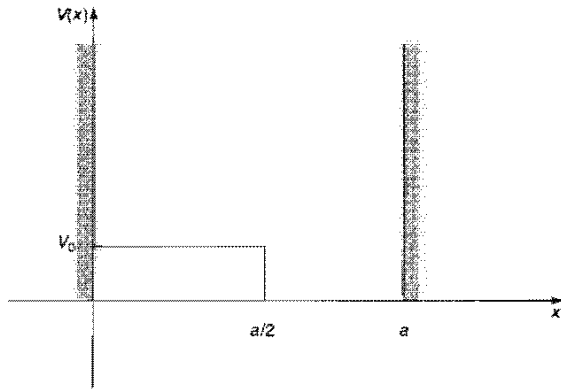

Figure 6.3: Constant perturbation over half the well.

The corrected energy levels, then, are $E_n \cong E_n^0 + V_0$; they are simply lifted by the amount V_0 . Of course! The only surprising thing is that in this case the first-order theory yields the *exact* answer. Evidently, for a *constant* perturbation all the higher corrections vanish.² If, on the other hand, the perturbation extends only halfway across the well (Figure 6.3), then

$$E_n^1 = \frac{2V_0}{a} \int_0^{a/2} \sin^2\left(\frac{n\pi}{a}x\right) dx = \frac{V_0}{2}.$$

In this case every energy level is lifted by $V_0/2$. That's not the *exact* result, presumably, but it does seem reasonable as a first-order approximation.

Equation 6.9 is the first-order correction to the *energy*; to find the first-order correction to the *wave function* we first rewrite Equation 6.7:

$$(H^0 - E_n^0)\psi_n^1 = -(H' - E_n^1)\psi_n^0. \quad [6.10]$$

The right side is a known function, so this amounts to an inhomogeneous differential equation for ψ_n^1 . Now, the unperturbed wave functions constitute a complete set, so ψ_n^1 (like any other function) can be expressed as a linear combination of them:

$$\psi_n^1 = \sum_{m \neq n} c_m^{(n)} \psi_m^0. \quad [6.11]$$

[There is no need to include $m = n$ in the sum, for if ψ_n^1 satisfies Equation 6.10, so too does $(\psi_n^1 + \alpha\psi_n^0)$, for any constant α , and we can use this freedom to subtract off the ψ_n^0 term.³] If we could determine the coefficients $c_m^{(n)}$, we'd be done. Well, putting Equation 6.11 into Equation 6.10, and using the fact that the ψ_m^0 satisfies the

²Incidentally, nothing here depends on the specific nature of the infinite square well—the same result applies for *any* potential, when the perturbation is constant.

³Alternatively, a glance at Equation 6.5 reveals that any ψ_n^0 component in ψ_n^1 might as well be pulled out and combined with the first term. We are *only* concerned, for the moment, with solving the Schrödinger equation (Equation 6.3), and the ψ_n we get will not, in general, be normalized.

unperturbed Schrödinger equation (Equation 6.1), we have

$$\sum_{m \neq n} (E_m^0 - E_n^0) c_m^{(n)} \psi_m^0 = -(H' - E_n^1) \psi_n^0.$$

Taking the inner product with ψ_l^0 ,

$$\sum_{m \neq n} (E_m^0 - E_n^0) c_m^{(n)} \langle \psi_l^0 | \psi_m^0 \rangle = -\langle \psi_l^0 | H' | \psi_n^0 \rangle + E_n^1 \langle \psi_l^0 | \psi_n^0 \rangle.$$

If $l = n$, the left side is zero, and we recover Equation 6.9; if $l \neq n$, we get

$$(E_l^0 - E_n^0) c_l^{(n)} = -\langle \psi_l^0 | H' | \psi_n^0 \rangle,$$

or

$$c_m^{(n)} = \frac{\langle \psi_m^0 | H' | \psi_n^0 \rangle}{E_n^0 - E_m^0}, \tag{6.12}$$

so

$$\psi_n^1 = \sum_{m \neq n} \frac{\langle \psi_m^0 | H' | \psi_n^0 \rangle}{(E_n^0 - E_m^0)} \psi_m^0. \tag{6.13}$$

Notice that the denominator is safe, since there is no coefficient with $m = n$, as long as the unperturbed energy spectrum is nondegenerate. But if two different unperturbed states share the same energy, we're in serious trouble (we divided by zero to get Equation 6.12); in that case we need **degenerate perturbation theory**, which I'll come to in Section 6.2.

That completes first-order perturbation theory: E_n^1 is given by Equation 6.9, and ψ_n^1 is given by Equation 6.13. I should warn you that whereas perturbation theory often yields surprisingly accurate energies (that is, $E_n^0 + E_n^1$ is quite close to the exact value E_n), the wave functions are notoriously poor.

***Problem 6.1** Suppose we put a delta-function bump in the center of the infinite square well:

$$H' = \alpha \delta(x - a/2),$$

where α is a constant. Find the first-order correction to the allowed energies. Explain why the energies are not perturbed for even n .

***Problem 6.2** For the harmonic oscillator [$V(x) = (1/2)kx^2$], the allowed energies are

$$E_n = (n + 1/2)\hbar\omega, \quad (n = 0, 1, 2, \dots),$$

where $\omega = \sqrt{k/m}$ is the classical frequency. Now suppose the spring constant increases slightly: $k \rightarrow (1 + \epsilon)k$. (Perhaps we cool the spring, so it becomes less flexible.)

- (a) Find the *exact* new energies (trivial, in this case). Expand your formula as a power series in ϵ , up to second order.
- (b) Now calculate the first-order perturbation in the energy, using Equation 6.6. What is H' here? Compare your result with part (a). *Hint*: It is not necessary—in fact, it is not *permitted*—to calculate a single integral in doing this problem.

Problem 6.3 Two identical bosons are placed in an infinite square well (Equation 2.15). They interact weakly with one another, via the potential

$$V(x_1, x_2) = -aV_0\delta(x_1 - x_2)$$

(where V_0 is a constant with the dimensions of energy and a is the width of the well)

- (a) First, ignoring the interaction between the particles, find the ground state and first excited state—both the wave functions and the associated energies.
- (b) Use first-order perturbation theory to calculate the effect of the particle-particle interaction on the ground and first excited state energies.

6.1.3 Second-Order Energies

Proceeding as before, we take the inner product of the *second-order* equation (Equation 6.8) with ψ_n^0 :

$$\langle \psi_n^0 | H^0 \psi_n^2 \rangle + \langle \psi_n^0 | H' \psi_n^1 \rangle = E_n^0 \langle \psi_n^0 | \psi_n^2 \rangle + E_n^1 \langle \psi_n^0 | \psi_n^1 \rangle + E_n^2 \langle \psi_n^0 | \psi_n^0 \rangle.$$

Again, we exploit the Hermiticity of H^0 :

$$\langle \psi_n^0 | H^0 \psi_n^2 \rangle = \langle H^0 \psi_n^0 | \psi_n^2 \rangle = E_n^0 \langle \psi_n^0 | \psi_n^2 \rangle,$$

so the first term on the left cancels the first term on the right. Meanwhile, $\langle \psi_n^0 | \psi_n^0 \rangle = 1$, and we are left with a formula for E_n^2 :

$$E_n^2 = \langle \psi_n^0 | H' | \psi_n^1 \rangle - E_n^1 \langle \psi_n^0 | \psi_n^1 \rangle.$$

But

$$\langle \psi_n^0 | \psi_n^1 \rangle = \sum_{m \neq n} c_m^{(n)} \langle \psi_n^0 | \psi_m^0 \rangle = 0,$$

so

$$E_n^2 = \langle \psi_n^0 | H' | \psi_n^1 \rangle = \sum_{m \neq n} c_m^{(n)} \langle \psi_n^0 | H' | \psi_m^0 \rangle = \sum_{m \neq n} \frac{\langle \psi_m^0 | H' | \psi_n^0 \rangle \langle \psi_n^0 | H' | \psi_m^0 \rangle}{E_n^0 - E_m^0},$$

or, finally,

$$E_n^2 = \sum_{m \neq n} \frac{|\langle \psi_m^0 | H' | \psi_n^0 \rangle|^2}{E_n^0 - E_m^0}. \quad [6.14]$$

This is the fundamental result of second-order perturbation theory. We could proceed to calculate the second-order correction to the wave function (ψ_n^2), the third-order correction to the energy, and so on, but in practice Equation 6.14 is ordinarily as high as it is useful to pursue this method.

****Problem 6.4**

- (a) Find the second-order correction to the energies (E_n^2) for the potential in Problem 6.1. *Note:* You can sum the series explicitly to obtain the result $-2m(\alpha/\pi\hbar n)^2$, for odd n .
- (b) Calculate the second-order correction to the ground-state energy (E_0^2) for the potential in Problem 6.2. Check that your result is consistent with the exact solution.

****Problem 6.5** Consider a charged particle in the one-dimensional harmonic oscillator potential. Suppose we turn on a weak electric field (E) so that the potential energy is shifted by an amount $H' = -qEx$.

- (a) Show that there is no first-order change in the energy levels, and calculate the second-order correction. *Hint:* See Problem 3.50.
- (b) The Schrödinger equation can be solved exactly in this case by a change of variables: $x' \equiv x - (qE/m\omega^2)$. Find the exact energies, and show that they are consistent with the perturbation theory approximation.
-

6.2 DEGENERATE PERTURBATION THEORY

If the unperturbed states are degenerate—that is, if two (or more) distinct states (ψ_a^0 and ψ_b^0) share the same energy—then ordinary perturbation theory fails: $c_a^{(b)}$ (Equation 6.12) and E_a^2 (Equation 6.14) blow up (unless, possibly, the numerator vanishes, $\langle \psi_a^0 | H' | \psi_b^0 \rangle = 0$ —a loophole that will be important to us later on). In the degenerate case, therefore, there is no reason to trust even the *first*-order correction to the energy (Equation 6.9), and we must look for some other way to handle the problem.

6.2.1 Twofold Degeneracy

Suppose that

$$H^0 \psi_a^0 = E^0 \psi_a^0, \quad H^0 \psi_b^0 = E^0 \psi_b^0, \quad \text{and} \quad \langle \psi_a^0 | \psi_b^0 \rangle = 0. \quad [6.15]$$

Note that any linear combination of these states,

$$\psi^0 = \alpha \psi_a^0 + \beta \psi_b^0, \quad [6.16]$$

is still an eigenstate of H^0 , with the same eigenvalue E^0 :

$$H^0\psi^0 = E^0\psi^0. \quad [6.17]$$

Typically, the perturbation (H') will “break” the degeneracy: As we increase λ (from 0 to 1), the common unperturbed energy E^0 splits into two (Figure 6.4).

The essential problem is this: When we turn *off* the perturbation, the “upper” state reduces down to *one* linear combination of ψ_a^0 and ψ_b^0 , and the “lower” state reduces to some *other* linear combination, but we don’t know a priori *what* these “good” linear combinations will be. For this reason we can’t even calculate the *first-order* energy (Equation 6.9) because we don’t know what unperturbed states to use.

For the moment, therefore, let’s just write the “good” unperturbed states in the general form (Equation 6.16), keeping α and β adjustable. We want to solve the Schrödinger equation,

$$H\psi = E\psi, \quad [6.18]$$

with $H = H^0 + \lambda H'$ and

$$E = E^0 + \lambda E^1 + \lambda^2 E^2 + \dots, \quad \psi = \psi^0 + \lambda \psi^1 + \lambda^2 \psi^2 + \dots. \quad [6.19]$$

Plugging these into Equation 6.18, and collecting like powers of λ , as before, we find

$$H^0\psi^0 + \lambda(H'\psi^0 + H^0\psi^1) + \dots = E^0\psi^0 + \lambda(E^1\psi^0 + E^0\psi^1) + \dots.$$

But $H^0\psi^0 = E^0\psi^0$ (Equation 6.17), so the first terms cancel; at order λ^1 we have

$$H^0\psi^1 + H'\psi^0 = E^0\psi^1 + E^1\psi^0. \quad [6.20]$$

Taking the inner product with ψ_a^0 :

$$\langle \psi_a^0 | H^0 \psi^1 \rangle + \langle \psi_a^0 | H' \psi^0 \rangle = E^0 \langle \psi_a^0 | \psi^1 \rangle + E^1 \langle \psi_a^0 | \psi^0 \rangle.$$

Because H^0 is Hermitian, the first term on the left cancels the first term on the right. Putting in Equation 6.16 and exploiting the orthonormality condition Equation 6.15, we obtain

$$\alpha \langle \psi_a^0 | H' | \psi_a^0 \rangle + \beta \langle \psi_a^0 | H' | \psi_b^0 \rangle = \alpha E^1,$$

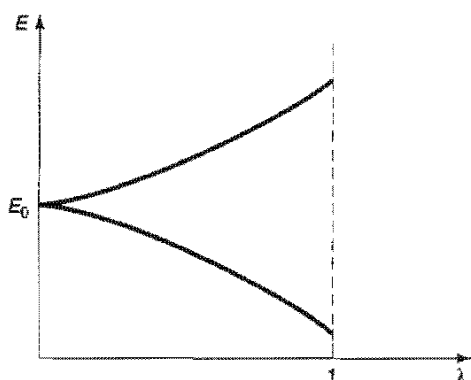

Figure 6.4: “Lifting” of a degeneracy by a perturbation.

or, more compactly,

$$\alpha W_{aa} + \beta W_{ab} = \alpha E^1, \quad [6.21]$$

where

$$W_{ij} \equiv \langle \psi_i^0 | H' | \psi_j^0 \rangle, \quad (i, j = a, b). \quad [6.22]$$

Similarly, the inner product with ψ_b^0 yields

$$\alpha W_{ba} + \beta W_{bb} = \beta E^1. \quad [6.23]$$

Notice that the W 's are (in principle) *known*—they are just the “matrix elements” of H' , with respect to the unperturbed wave functions ψ_a^0 and ψ_b^0 . Multiplying Equation 6.23 by W_{ab} , and using Equation 6.21 to eliminate βW_{ab} , we find

$$\alpha [W_{ab}W_{ba} - (E^1 - W_{aa})(E^1 - W_{bb})] = 0. \quad [6.24]$$

If α is *not* zero, Equation 6.24 yields an equation for E^1 :

$$(E^1)^2 - E^1(W_{aa} + W_{bb}) + (W_{aa}W_{bb} - W_{ab}W_{ba}) = 0. \quad [6.25]$$

Invoking the quadratic formula, and noting (from Equation 6.22) that $W_{ba} = W_{ab}^*$, we conclude that

$$E_{\pm}^1 = \frac{1}{2} \left[W_{aa} + W_{bb} \pm \sqrt{(W_{aa} - W_{bb})^2 + 4|W_{ab}|^2} \right]. \quad [6.26]$$

This is the fundamental result of degenerate perturbation theory; the two roots correspond to the two perturbed energies.

But what if α is zero? In that case $\beta = 1$, Equation 6.21 says $W_{ab} = 0$, and Equation 6.23 gives $E^1 = W_{bb}$. This is actually included in the general result (Equation 6.26), with the plus sign (the minus sign corresponds to $\alpha = 1, \beta = 0$). What's more, the *answers*,

$$E_+^1 = W_{bb} = \langle \psi_b^0 | H' | \psi_b^0 \rangle, \quad E_-^1 = W_{aa} = \langle \psi_a^0 | H' | \psi_a^0 \rangle,$$

are precisely what we would have obtained using *nondegenerate* perturbation theory (Equation 6.9)—we have simply been *lucky*: The states ψ_a^0 and ψ_b^0 were *already* the “correct” linear combinations. Obviously, it would be greatly to our advantage if we could somehow *guess* the “good” states right from the start. In practice, we can often do so by exploiting the following theorem:

Theorem: Let A be a Hermitian operator that commutes with H' . If ψ_a^0 and ψ_b^0 are eigenfunctions of A with distinct eigenvalues,

$$A\psi_a^0 = \mu\psi_a^0, \quad A\psi_b^0 = \nu\psi_b^0, \quad \text{and } \mu \neq \nu,$$

then $W_{ab} = 0$ (and hence ψ_a^0 and ψ_b^0 are the “good” states to use in perturbation theory).

Proof: By assumption, $[A, H'] = 0$, so

$$\begin{aligned} \langle \psi_a^0 | [A, H'] | \psi_b^0 \rangle &= 0 \\ &= \langle \psi_a^0 | A H' | \psi_b^0 \rangle - \langle \psi_a^0 | H' A | \psi_b^0 \rangle \\ &= \langle A \psi_a^0 | H' | \psi_b^0 \rangle - \langle \psi_a^0 | H' | \nu \psi_b^0 \rangle \\ &= (\mu - \nu) \langle \psi_a^0 | H' | \psi_b^0 \rangle = (\mu - \nu) W_{ab}. \end{aligned}$$

But $\mu \neq \nu$, so $W_{ab} = 0$. QED

Moral: If you're faced with degenerate states, look around for some Hermitian operator A that commutes with H' ; pick as your unperturbed states ones that are simultaneously eigenfunctions of H^0 and A . Then use *ordinary* first-order perturbation theory. If you can't find such an operator, you'll have to resort to Equation 6.26, but in practice this is seldom necessary.

Problem 6.6 Let the two "good" unperturbed states be

$$\psi_{\pm}^0 = \alpha_{\pm} \psi_a^0 + \beta_{\pm} \psi_b^0,$$

where α_{\pm} and β_{\pm} are determined (up to normalization) by Equation 6.21 (or Equation 6.23), with Equation 6.26 for E_{\pm} . Show explicitly that

- (a) ψ_{\pm}^0 are orthogonal ($\langle \psi_+^0 | \psi_-^0 \rangle = 0$);
- (b) $\langle \psi_+^0 | H' | \psi_-^0 \rangle = 0$;
- (c) $\langle \psi_{\pm}^0 | H' | \psi_{\pm}^0 \rangle = E_{\pm}^1$.

Problem 6.7 Consider a particle of mass m that is free to move in a one-dimensional region of length L that closes on itself (for instance, a bead which slides frictionlessly on a circular wire of circumference L ; Problem 2.43).

- (a) Show that the stationary states can be written in the form

$$\psi_n(x) = \frac{1}{\sqrt{L}} e^{2\pi i n x / L}, \quad (-L/2 < x < L/2),$$

where $n = 0, \pm 1, \pm 2, \dots$, and the allowed energies are

$$E_n = \frac{2}{m} \left(\frac{n\pi\hbar}{L} \right)^2.$$

Notice that—with the exception of the ground state ($n = 0$)—these are all doubly degenerate.

- (b) Now suppose we introduce the perturbation

$$H' = -V_0 e^{-x^2/a^2},$$

where $a \ll L$. (This puts a little “dimple” in the potential at $x = 0$, as though we bent the wire slightly to make a “trap.”) Find the first-order correction to E_n , using Equation 6.26. *Hint:* To evaluate the integrals, exploit the fact that $a \ll L$ to extend the limits from $\pm L/2$ to $\pm\infty$; after all, H' is essentially zero outside $-a < x < a$.

- (c) What are the “good” linear combinations of ψ_n and ψ_{-n} for this problem? Show that with these states you get the first-order correction using Equation 6.9.
- (d) Find a Hermitian operator A that fits the requirements of the theorem, and show that the simultaneous eigenstates of H^0 and A are precisely the ones you found in (c).

6.2.2 Higher-Order Degeneracy

In the previous section I assumed the degeneracy was twofold, but it is easy to see how the method generalizes. Rewrite Equations 6.21 and 6.23 in matrix form:

$$\begin{pmatrix} W_{aa} & W_{ab} \\ W_{ba} & W_{bb} \end{pmatrix} \begin{pmatrix} \alpha \\ \beta \end{pmatrix} = E^1 \begin{pmatrix} \alpha \\ \beta \end{pmatrix}. \quad [6.27]$$

Evidently the E^1 's are nothing but the *eigenvalues* of the W -matrix; Equation 6.25 is the characteristic equation (Equation 3.70) for this matrix, and the “good” linear combinations of the unperturbed states are the *eigenvectors* of W . In the case of n -fold degeneracy, we look for the eigenvalues of the $n \times n$ matrix

$$W_{ij} = \langle \psi_i^0 | H' | \psi_j^0 \rangle. \quad [6.28]$$

In the language of linear algebra, finding the “good” unperturbed wave functions amounts to constructing a basis in the degenerate subspace that *diagonalizes* the perturbation H' . Once again, if you can think of an operator A that *commutes* with H' , and use the simultaneous eigenfunctions of A and H^0 , then the W matrix will *automatically* be diagonal, and you won't have to fuss with solving the characteristic equation.

Example. Consider the three-dimensional infinite cubical well (Problem 4.2):

$$V(x, y, z) = \begin{cases} 0, & \text{if } 0 < x < a, 0 < y < a, \text{ and } 0 < z < a; \\ \infty & \text{otherwise.} \end{cases} \quad [6.29]$$

The stationary states are

$$\psi_{n_x n_y n_z}^0(x, y, z) = \left(\frac{2}{a}\right)^{3/2} \sin\left(\frac{n_x \pi}{a} x\right) \sin\left(\frac{n_y \pi}{a} y\right) \sin\left(\frac{n_z \pi}{a} z\right), \quad [6.30]$$

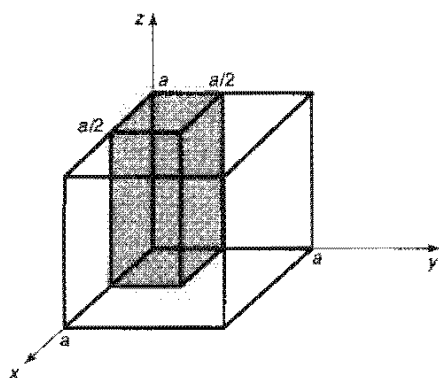

Figure 6.5: The perturbation increases the potential by an amount V_0 in the shaded sector.

where n_x , n_y , and n_z are positive integers. The corresponding allowed energies are

$$E_{n_x n_y n_z}^0 = \frac{\pi^2 \hbar^2}{2ma^2} (n_x^2 + n_y^2 + n_z^2). \quad [6.31]$$

Notice that the ground state (ψ_{111}) is nondegenerate; its energy is

$$E_0^0 \equiv 3 \frac{\pi^2 \hbar^2}{2ma^2}. \quad [6.32]$$

But the first excited state is (triply) degenerate:

$$\psi_a \equiv \psi_{112}, \quad \psi_b \equiv \psi_{121}, \quad \text{and} \quad \psi_c \equiv \psi_{211}, \quad [6.33]$$

all share the energy

$$E_1^0 \equiv 3 \frac{\pi^2 \hbar^2}{ma^2}. \quad [6.34]$$

Now let's introduce the perturbation

$$H' = \begin{cases} V_0, & \text{if } 0 < x < a/2 \text{ and } 0 < y < a/2; \\ 0, & \text{otherwise.} \end{cases} \quad [6.35]$$

This raises the potential by an amount V_0 in one quarter of the box (see Figure 6.5). The first-order correction to the ground state energy is given by Equation 6.9:

$$E_0^1 = \langle \psi_{111} | H' | \psi_{111} \rangle = \left(\frac{2}{a} \right)^3 V_0 \int_0^{a/2} \sin^2 \left(\frac{\pi}{a} x \right) dx \int_0^{a/2} \sin^2 \left(\frac{\pi}{a} y \right) dy \int_0^a \sin^2 \left(\frac{\pi}{a} z \right) dz = \frac{1}{4} V_0, \quad [6.36]$$

which is just what we would expect.

For the first excited state we need the full machinery of degenerate perturbation theory. The first step is to construct the matrix W . The diagonal elements are the

same as for the ground state (except that the argument of one of the sines is doubled); you can check for yourself that

$$W_{aa} = W_{bb} = W_{cc} = \frac{1}{4}V_0.$$

The off-diagonal elements are more interesting:

$$W_{ab} = \left(\frac{2}{a}\right)^3 V_0 \int_0^{a/2} \sin^2\left(\frac{\pi}{a}x\right) dx \\ \int_0^{a/2} \sin\left(\frac{\pi}{a}y\right) \sin\left(\frac{2\pi}{a}y\right) dy \int_0^a \sin\left(\frac{2\pi}{a}z\right) \sin\left(\frac{\pi}{a}z\right) dz.$$

But the z integral is zero (as it will be also for W_{ac}), so

$$W_{ab} = W_{ac} = 0.$$

Finally,

$$W_{bc} = \left(\frac{2}{a}\right)^3 V_0 \int_0^{a/2} \sin\left(\frac{\pi}{a}x\right) \sin\left(\frac{2\pi}{a}x\right) dx \\ \int_0^{a/2} \sin\left(\frac{2\pi}{a}y\right) \sin\left(\frac{\pi}{a}y\right) dy \int_0^a \sin^2\left(\frac{\pi}{a}z\right) dz = \frac{16}{9\pi^2}V_0.$$

Thus

$$W = \frac{V_0}{4} \begin{pmatrix} 1 & 0 & 0 \\ 0 & 1 & \kappa \\ 0 & \kappa & 1 \end{pmatrix}, \quad [6.37]$$

where $\kappa \equiv (8/3\pi)^2 \approx 0.7205$.

The characteristic equation for W (or rather, for $4W/V_0$, which is easier to work with) is

$$(1-w)^3 - \kappa^2(1-w) = 0,$$

and the eigenvalues are

$$w_1 = 1; \quad w_2 = 1 + \kappa \approx 1.7205; \quad w_3 = 1 - \kappa \approx 0.2795.$$

To first order in λ , then,

$$E_1(\lambda) = \begin{cases} E_1^0 + \lambda V_0/4, \\ E_1^0 + \lambda(1 + \kappa)V_0/4, \\ E_1^0 + \lambda(1 - \kappa)V_0/4, \end{cases} \quad [6.38]$$

where E_1^0 is the (common) unperturbed energy (Equation 6.34). The perturbation lifts the degeneracy, splitting E_1^0 into three distinct energy levels (see Figure 6.6). Notice that if we had naively applied *nondegenerate* perturbation theory to this problem, we would have concluded that the first-order correction (Equation 6.9) is the

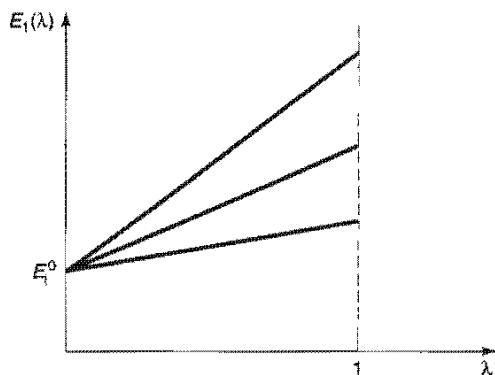

Figure 6.6: Lifting of the degeneracy in the example (Equation 6.38).

same for all three states, and equal to $V_0/4$ —which is actually correct only for the middle state.

Meanwhile, the “good” unperturbed states are linear combinations of the form

$$\psi^0 = \alpha\psi_a + \beta\psi_b + \gamma\psi_c, \quad [6.39]$$

where the coefficients (α , β , and γ) form the eigenvectors of the matrix W :

$$\begin{pmatrix} 1 & 0 & 0 \\ 0 & 1 & \kappa \\ 0 & \kappa & 1 \end{pmatrix} \begin{pmatrix} \alpha \\ \beta \\ \gamma \end{pmatrix} = w \begin{pmatrix} \alpha \\ \beta \\ \gamma \end{pmatrix}.$$

For $w = 1$ we get $\alpha = 1$, $\beta = \gamma = 0$; for $w = 1 \pm \kappa$ we get $\alpha = 0$, $\beta = \pm\gamma = 1/\sqrt{2}$. (I normalized them as I went along.) Thus the “good” states are⁴

$$\psi^0 = \begin{cases} \psi_a, \\ (\psi_b + \psi_c)/\sqrt{2}, \\ (\psi_b - \psi_c)/\sqrt{2}. \end{cases} \quad [6.40]$$

Problem 6.8 Suppose we perturb the infinite cubical well (Equation 6.29) by putting a delta-function “bump” at the point $(a/4, a/2, 3a/4)$:

$$H' = a^3 V_0 \delta(x - a/4) \delta(y - a/2) \delta(z - 3a/4).$$

Find the first-order corrections to the energy of the ground state and the (triply degenerate) first excited states.

⁴We might have guessed this result right from the start by noting that the operator P_{xy} , which interchanges x and y , commutes with H' . Its eigenvalues are $+1$ (for functions that are *even* under the interchange) and -1 (for functions that are *odd*). In this case ψ_a is *already* even, $(\psi_b + \psi_c)$ is even, and $(\psi_b - \psi_c)$ is odd. However, this is not quite conclusive, since any linear combination of the even states would still be even. What we'd *really* like is an operator with *three* distinct eigenvalues in the degenerate subspace.

***Problem 6.9** Consider a quantum system with just *three* linearly independent states. The Hamiltonian, in matrix form, is

$$H = V_0 \begin{pmatrix} (1 - \epsilon) & 0 & 0 \\ 0 & 1 & \epsilon \\ 0 & \epsilon & 2 \end{pmatrix},$$

where V_0 is a constant and ϵ is some small number ($\epsilon \ll 1$).

- (a) Write down the eigenvectors and eigenvalues of the *unperturbed* Hamiltonian ($\epsilon = 0$).
- (b) Solve for the *exact* eigenvalues of H . Expand each of them as a power series in ϵ , up to second order.
- (c) Use first- and second-order *nondegenerate* perturbation theory to find the approximate eigenvalue for the state that grows out of the nondegenerate eigenvector of H^0 . Compare the exact result from (b).
- (d) Use *degenerate* perturbation theory to find the first-order correction to the two initially degenerate eigenvalues. Compare the exact results.

6.3 THE FINE STRUCTURE OF HYDROGEN

In our study of the hydrogen atom (Section 4.2), we took the Hamiltonian to be

$$H = -\frac{\hbar^2}{2m} \nabla^2 - \frac{e^2}{4\pi\epsilon_0 r} \quad [6.41]$$

(electron kinetic energy plus Coulombic potential energy). But this is not quite the whole story. We have already learned how to correct for the motion of the nucleus: Just replace m by the reduced mass (Problem 5.1). More significant is the so-called **fine structure**, which is actually due to two distinct mechanisms: a **relativistic correction**, and **spin-orbit coupling**. Compared to the Bohr energies (Equation 4.70), fine structure is a tiny perturbation—smaller by a factor of α^2 , where

$$\alpha \equiv \frac{e^2}{4\pi\epsilon_0\hbar c} \cong \frac{1}{137.036} \quad [6.42]$$

is the famous **fine structure constant**. Smaller still (by another factor of α) is the **Lamb shift**, associated with the quantization of the Coulomb field, and smaller by yet another order of magnitude is the **hyperfine structure**, which is due to the magnetic interaction between the dipole moments of the electron and the proton. This hierarchy is summarized in Table 6.1.

Table 6.1: Hierarchy of corrections to the Bohr energies of hydrogen.

| | | |
|----------------------|----------|------------------------|
| Bohr energies: | of order | $\alpha^2 mc^2$ |
| Fine structure: | of order | $\alpha^4 mc^2$ |
| Lamb shift: | of order | $\alpha^5 mc^2$ |
| Hyperfine splitting: | of order | $(m/m_p)\alpha^4 mc^2$ |

In the present section we will analyze the fine structure of hydrogen, as an application of time-independent perturbation theory.

Problem 6.10

- (a) Express the Bohr energies in terms of the fine structure constant and the rest energy (mc^2) of the electron.
- (b) Calculate the fine structure constant from first principles (i.e. without recourse to the empirical values of ϵ_0 , e , \hbar , and c). *Note:* The fine structure constant is undoubtedly the most fundamental pure (dimensionless) number in all of physics: It relates the basic constants of electromagnetism (the charge of the electron), relativity (the speed of light), and quantum mechanics (Planck's constant). If you can solve part (b), you have the most certain Nobel Prize in history waiting for you. But I wouldn't recommend spending a lot of time on it right now; many smart people have tried and given up.

6.3.1 The Relativistic Correction

The first term in the Hamiltonian is supposed to represent kinetic energy:

$$T = \frac{1}{2}mv^2 = \frac{p^2}{2m}, \quad [6.43]$$

and the canonical substitution $\mathbf{p} \rightarrow (\hbar/i)\nabla$ yields the operator

$$\hat{T} = -\frac{\hbar^2}{2m}\nabla^2. \quad [6.44]$$

But Equation 6.43 is the *classical* equation for kinetic energy; the *relativistic* formula is

$$T = \frac{mc^2}{\sqrt{1 - (v/c)^2}} - mc^2. \quad [6.45]$$

The first term is the *total* relativistic energy (not counting *potential* energy, which we aren't concerned with at the moment), and the second term is the *rest* energy—the *difference* is the energy attributable to motion. We need to express T in terms of the

(relativistic) momentum,

$$p = \frac{mv}{\sqrt{1 - (v/c)^2}}, \quad [6.46]$$

instead of velocity. Notice that

$$p^2 c^2 + m^2 c^4 = \frac{m^2 v^2 c^2 + m^2 c^4 [1 - (v/c)^2]}{1 - (v/c)^2} = \frac{m^2 c^4}{1 - (v/c)^2} = (T + mc^2)^2,$$

so

$$T = \sqrt{p^2 c^2 + m^2 c^4} - mc^2. \quad [6.47]$$

This relativistic equation for kinetic energy reduces (of course) to the classical result (Equation 6.43), in the nonrelativistic limit $p \ll mc$; expanding in powers of the small number (p/mc) , we have

$$\begin{aligned} T &= mc^2 \left[\sqrt{1 + \left(\frac{p}{mc}\right)^2} - 1 \right] = mc^2 \left[1 + \frac{1}{2} \left(\frac{p}{mc}\right)^2 - \frac{1}{8} \left(\frac{p}{mc}\right)^4 + \dots - 1 \right] \\ &= \frac{p^2}{2m} - \frac{p^4}{8m^3 c^2} + \dots \end{aligned} \quad [6.48]$$

The lowest-order⁵ relativistic contribution to the Hamiltonian is evidently

$$H'_r = -\frac{\hat{p}^4}{8m^3 c^2}. \quad [6.49]$$

In first-order perturbation theory, the correction to E_n is given by the expectation value of H' in the unperturbed state (Equation 6.9):

$$E_r^1 = \langle H'_r \rangle = -\frac{1}{8m^3 c^2} \langle \psi | \hat{p}^4 \psi \rangle = -\frac{1}{8m^3 c^2} \langle \hat{p}^2 \psi | \hat{p}^2 \psi \rangle. \quad [6.50]$$

Now the Schrödinger equation (for the unperturbed states) says

$$\hat{p}^2 \psi = 2m(E - V)\psi, \quad [6.51]$$

and hence⁶

$$E_r^1 = -\frac{1}{2mc^2} \langle (E - V)^2 \rangle = -\frac{1}{2mc^2} [E^2 - 2E\langle V \rangle + \langle V^2 \rangle]. \quad [6.52]$$

⁵The kinetic energy of the electron in hydrogen is on the order of 10 eV, which is miniscule compared to its rest energy (511,000 eV), so the hydrogen atom is basically nonrelativistic, and we can afford to keep only the lowest-order correction. In Equation 6.48, p is the *relativistic* momentum (Equation 6.46), *not* the classical momentum mv . It is the former that we now associate with the quantum operator $-i\hbar\nabla$, in Equation 6.49.

⁶There is some sleight-of-hand in this maneuver, which exploits the Hermiticity of \hat{p}^2 and of $(E - V)$. In truth, the operator \hat{p}^4 is not Hermitian, for states with $l = 0$, and the applicability of perturbation theory to Equation 6.49 is therefore called into question. Fortunately, the *exact* solution is available; it can be obtained by using the (relativistic) Dirac equation in place of the (nonrelativistic) Schrödinger equation, and it confirms the results we obtain here by less rigorous means. (See Problem 6.17.)

So far, this is entirely general; but we're interested in the case of hydrogen, for which $V(r) = -(1/4\pi\epsilon_0)e^2/r$:

$$E_r^1 = -\frac{1}{2mc^2} \left[E_n^2 + 2E_n \left(\frac{e^2}{4\pi\epsilon_0} \right) \left\langle \frac{1}{r} \right\rangle + \left(\frac{e^2}{4\pi\epsilon_0} \right)^2 \left\langle \frac{1}{r^2} \right\rangle \right], \quad [6.53]$$

where E_n is the Bohr energy of the state in question.

To complete the job, we need the expectation values of $1/r$ and $1/r^2$ in the (unperturbed) state ψ_{nlm} (Equation 4.89). The first is easy (see Problem 6.11):

$$\left\langle \frac{1}{r} \right\rangle = \frac{1}{n^2 a}, \quad [6.54]$$

where a is the Bohr radius (Equation 4.72). The second is not so simple to derive (see Problem 6.28), but the answer is⁷

$$\left\langle \frac{1}{r^2} \right\rangle = \frac{1}{(l + 1/2)n^3 a^2}. \quad [6.55]$$

It follows that

$$E_r^1 = -\frac{1}{2mc^2} \left[E_n^2 + 2E_n \left(\frac{e^2}{4\pi\epsilon_0} \right) \frac{1}{n^2 a} + \left(\frac{e^2}{4\pi\epsilon_0} \right)^2 \frac{1}{(l + 1/2)n^3 a^2} \right],$$

or, eliminating a (using Equation 4.72) and expressing everything in terms of E_n (using Equation 4.70),

$$E_r^1 = -\frac{E_n^2}{2mc^2} \left[\frac{4n}{l + 1/2} - 3 \right]. \quad [6.56]$$

Notice that the relativistic correction is smaller than E_n by a factor of $E_n/mc^2 \approx 2 \times 10^{-5}$.

You might have noticed that I used *nondegenerate* perturbation theory in this calculation even though the hydrogen atom is highly degenerate. But the perturbation is spherically symmetrical, so it commutes with L^2 and L_z . Moreover, the eigenfunctions of these operators (taken together) have distinct eigenvalues for the n^2 states with a given E_n . Luckily, then, the wave functions ψ_{nlm} are "good" states for this problem, so as it happens the use of nondegenerate perturbation theory was legitimate.

***Problem 6.11** Use the virial theorem (Problem 4.41) to prove Equation 6.54.

⁷The general formula for the expectation value of any power of r is given in Hans A. Bethe and Edwin E. Salpeter, *Quantum Mechanics of One- and Two-Electron Atoms*, (New York: Plenum, 1977), p. 17.

Problem 6.12 In Problem 4.43, you calculated the expectation value of r^s in the state ψ_{321} . Check your answer for the special cases $s = 0$ (trivial), $s = -1$ (Equation 6.54), $s = -2$ (Equation 6.55), and $s = -3$ (Equation 6.63). Comment on the case $s = -7$.

****Problem 6.13** Find the (lowest-order) relativistic correction to the energy levels of the one-dimensional harmonic oscillator. *Hint:* Use the technique of Problem 2.37.

6.3.2 Spin-Orbit Coupling

Imagine the electron in orbit around the nucleus; from the *electron's* point of view, the proton is circling around *it* (Figure 6.7). This orbiting positive charge sets up a magnetic field \mathbf{B} in the electron frame, which exerts a torque on the spinning electron, tending to align its magnetic moment ($\boldsymbol{\mu}$) along the direction of the field. The Hamiltonian (Equation 4.157) is

$$H = -\boldsymbol{\mu} \cdot \mathbf{B}. \quad [6.57]$$

The Magnetic Field of the Proton. If we picture the proton (from the electron's perspective) as a continuous current loop (Figure 6.7), its magnetic field can be calculated from the Biot-Savart law:

$$B = \frac{\mu_0 I}{2r},$$

with an effective current $I = e/T$, where e is the charge of the proton and T is the period of the orbit. On the other hand, the orbital angular momentum of the *electron* (in the rest frame of the *nucleus*) is $L = r m v = 2\pi m r^2 / T$. Moreover, \mathbf{B} and \mathbf{L} point in the same direction (up, in Figure 6.7), so

$$\mathbf{B} = \frac{1}{4\pi\epsilon_0} \frac{e}{m c^2 r^3} \mathbf{L}. \quad [6.58]$$

(I used $c = 1/\sqrt{\epsilon_0\mu_0}$ to eliminate μ_0 in favor of ϵ_0 .)

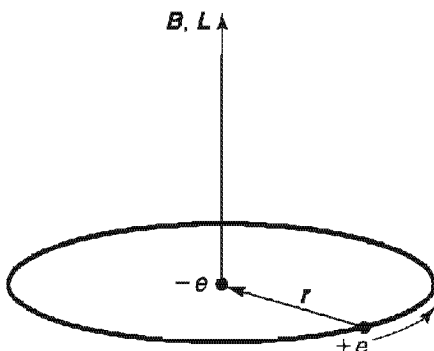

Figure 6.7: Hydrogen atom, from the electron's perspective.

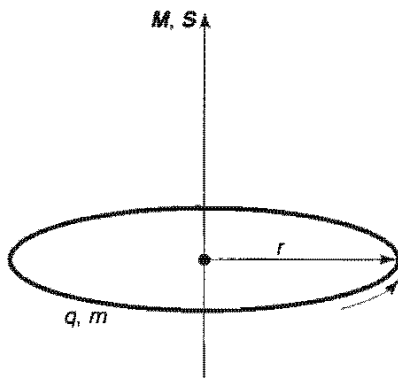

Figure 6.8: A ring of charge, rotating about its axis.

The Magnetic Dipole Moment of the Electron. The magnetic dipole moment of a spinning charge is related to its (spin) angular momentum; the proportionality factor is the gyromagnetic ratio (which we already encountered in Section 4.4.2). Let's derive it, using classical electrodynamics. Consider first a charge q smeared out around a ring of radius r , which rotates about the axis with period T (Figure 6.8). The magnetic dipole moment of the ring is defined as the current (q/T) times the area (πr^2):

$$\mu = \frac{q\pi r^2}{T}.$$

If the mass of the ring is m , its angular momentum is the moment of inertia (mr^2) times the angular velocity ($2\pi/T$):

$$S = \frac{2\pi mr^2}{T}.$$

The gyromagnetic ratio for this configuration is evidently $\mu/S = q/2m$. Notice that it is independent of r (and T). If I had some more complicated object, such as a sphere (all I require is that it be a figure of revolution, rotating about its axis). I could calculate μ and S by chopping it into little rings and adding their contributions. As long as the mass and the charge are distributed in the same manner (so that the charge-to-mass ratio is uniform), the gyromagnetic ratio will be the same for each ring, and hence also for the object as a whole. Moreover, the directions of μ and S are the same (or opposite, if the charge is negative), so

$$\mu = \left(\frac{q}{2m}\right) S.$$

That was a purely *classical* calculation, however; as it turns out, the electron's magnetic moment is *twice* the classical answer:

$$\mu_e = -\frac{e}{m} S. \quad [6.59]$$

The “extra” factor of 2 was explained by Dirac in his relativistic theory of the electron.⁸

The Spin-Orbit Interaction. Putting all this together, we have

$$H = \left(\frac{e^2}{4\pi\epsilon_0} \right) \frac{1}{m^2 c^2 r^3} \mathbf{S} \cdot \mathbf{L}.$$

But there is a serious fraud in this calculation: I did the analysis in the rest frame of the electron, but that’s *not an inertial system*—it *accelerates* as the electron orbits around the nucleus. You can get away with this if you make an appropriate kinematic correction, known as the **Thomas precession**.⁹ In this context it throws in a factor of 1/2:

$$H'_{\text{so}} = \left(\frac{e^2}{8\pi\epsilon_0} \right) \frac{1}{m^2 c^2 r^3} \mathbf{S} \cdot \mathbf{L}. \quad [6.60]$$

This is the spin-orbit interaction; apart from two corrections (the modified gyromagnetic ratio for the electron and the Thomas precession factor—which, coincidentally, exactly cancel one another), it is just what you would expect on the basis of a naive classical model. Physically, it is attributable to the torque exerted on the magnetic dipole moment of the spinning electron, by the magnetic field of the proton, in the electron’s instantaneous rest frame.

Now the quantum mechanics. In the presence of spin-orbit coupling, the Hamiltonian no longer commutes with \mathbf{L} and \mathbf{S} , so the spin and orbital angular momenta are not separately conserved (see Problem 6.14). However, H'_{so} *does* commute with L^2 , S^2 , and the *total* angular momentum

$$\mathbf{J} \equiv \mathbf{L} + \mathbf{S}, \quad [6.61]$$

and hence these quantities *are* conserved (Equation 3.148). To put it another way, the eigenstates of L_z and S_z are not “good” states to use in perturbation theory, but the eigenstates of L^2 , S^2 , J^2 , and J_z are. Now

$$J^2 = (\mathbf{L} + \mathbf{S}) \cdot (\mathbf{L} + \mathbf{S}) = L^2 + S^2 + 2\mathbf{L} \cdot \mathbf{S},$$

⁸We have already noticed that it can be dangerous to picture the electron as a spinning sphere (see Problem 4.26), and it is not too surprising that this naive classical model gets the gyromagnetic ratio wrong. Incidentally, quantum electrodynamics reveals tiny corrections to Equation 6.59; the calculation of the so-called **anomalous magnetic moment** of the electron stands as one of the greatest achievements of theoretical physics.

⁹One way of thinking of it is that we are continually stepping from one inertial system to another; Thomas precession amounts to the cumulative effect of all these Lorentz transformations. We could avoid this problem, of course, by staying in the *lab* frame, in which the nucleus is at rest. In that case the field of the proton is purely *electric*, and you may well wonder why it exerts any torque on the electron. Well, the fact is that a moving *magnetic* dipole acquires an *electric* dipole moment, and in the lab frame the spin-orbit coupling is due to the interaction of the *electric* field of the nucleus with the *electric* dipole moment of the electron. Because this analysis requires more sophisticated electrodynamics, it seems best to adopt the electron’s perspective, where the physical mechanism is more transparent. For a related discussion, see V. Namias, *Am. J. Phys.*, 57, 171 (1989).

so

$$\mathbf{L} \cdot \mathbf{S} = \frac{1}{2}(J^2 - L^2 - S^2), \quad [6.62]$$

and therefore the eigenvalues of $\mathbf{L} \cdot \mathbf{S}$ are

$$\frac{\hbar^2}{2}[j(j+1) - l(l+1) - s(s+1)].$$

In this case, of course, $s = 1/2$. Meanwhile, the expectation value of $1/r^3$ (see Problem 6.30) is

$$\left\langle \frac{1}{r^3} \right\rangle = \frac{1}{l(l+1/2)(l+1)n^3a^3}, \quad [6.63]$$

and we conclude that

$$E_{\text{so}}^1 = \langle H'_{\text{so}} \rangle = \frac{e^2}{8\pi\epsilon_0} \frac{1}{m^2c^2} \frac{(\hbar^2/2)[j(j+1) - l(l+1) - 3/4]}{l(l+1/2)(l+1)n^3a^3},$$

or, expressing it all in terms of E_n :

$$E_{\text{so}}^1 = \frac{E_n^2}{mc^2} \left\{ \frac{n[j(j+1) - l(l+1) - 3/4]}{l(l+1/2)(l+1)} \right\}. \quad [6.64]$$

It is remarkable, considering the totally different physical mechanisms involved, that the relativistic correction and the spin-orbit coupling are of the same order (E_n^2/mc^2). Adding them together, we get the complete fine-structure formula (see Problem 6.15):

$$E_{\text{fs}}^1 = \frac{E_n^2}{2mc^2} \left(3 - \frac{4n}{j+1/2} \right). \quad [6.65]$$

Combining this with the Bohr formula, we obtain the grand result for the energy levels of hydrogen, including fine structure:

$$E_{nj} = -\frac{13.6 \text{ eV}}{n^2} \left[1 + \frac{\alpha^2}{n^2} \left(\frac{n}{j+1/2} - \frac{3}{4} \right) \right]. \quad [6.66]$$

Fine structure breaks the degeneracy in l (that is, for a given n , the different allowed values of l do not all carry the same energy); the energies are determined by n and j (see Figure 6.9). The azimuthal eigenvalues for orbital and spin angular momentum (m_l and m_s) are no longer “good” quantum numbers—the stationary states are linear combinations of states with different values of these quantities; the “good” quantum numbers are n , l , s , j , and m_j .¹⁰

¹⁰To write $|jm_j\rangle$ (for given l and s) as a linear combination of $|lm_l\rangle|sm_s\rangle$ we would use the appropriate Clebsch-Gordan coefficients (Equation 4.185).

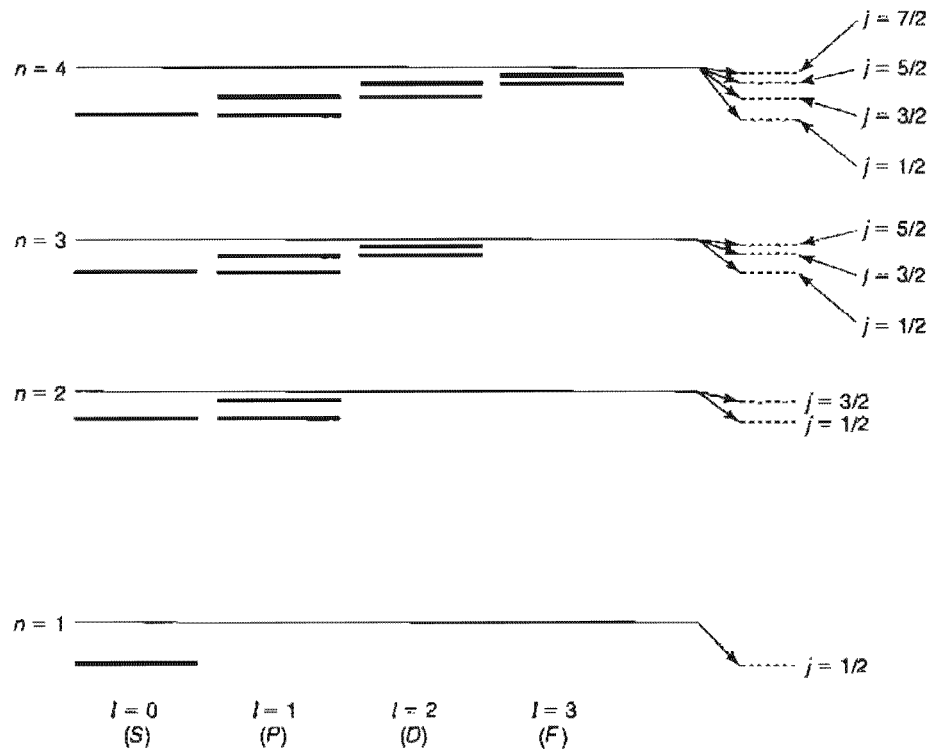

Figure 6.9: Energy levels of hydrogen, including fine structure (not to scale).

Problem 6.14 Evaluate the following commutators: (a) $[\mathbf{L} \cdot \mathbf{S}, \mathbf{L}]$, (b) $[\mathbf{L} \cdot \mathbf{S}, \mathbf{S}]$, (c) $[\mathbf{L} \cdot \mathbf{S}, \mathbf{J}]$, (d) $[\mathbf{L} \cdot \mathbf{S}, L^2]$, (e) $[\mathbf{L} \cdot \mathbf{S}, S^2]$, (f) $[\mathbf{L} \cdot \mathbf{S}, J^2]$. *Hint:* \mathbf{L} and \mathbf{S} satisfy the fundamental commutation relations for angular momentum (Equations 4.98, 4.99, and 4.134), but they commute with each other.

***Problem 6.15** Derive the fine structure formula (Equation 6.65) from the relativistic correction (Equation 6.56) and the spin-orbit coupling (Equation 6.64). *Hint:* Note that $j = l \pm 1/2$; treat the plus sign and the minus sign separately, and you'll find that you get the same final answer either way.

****Problem 6.16** The most prominent feature of the hydrogen spectrum in the visible region is the red Balmer line, coming from the transition $n = 3$ to $n = 2$. First of all, determine the wavelength and frequency of this line, according to the Bohr theory. Fine structure splits this line into several closely spaced lines; the question is: *How many, and what is their spacing?* *Hint:* First determine how many sublevels the $n = 2$ level splits into, and find $E_{j_s}^1$ for each of these, in eV. Then do the same for $n = 3$. Draw an energy level diagram showing all possible transitions from $n = 3$ to $n = 2$. The energy released (in the form of a photon) is $(E_3 - E_2) + \Delta E$, the first part being common to all of them, and the ΔE (due to fine structure) varying from one transition to the next. Find ΔE (in eV) for each transition. Finally, convert to photon frequency, and determine the spacing between adjacent spectral lines (in Hz)—*not* the frequency interval between each line and the *unperturbed* line (which

is, of course, unobservable), but the frequency interval between each line and the next one. Your final answer should take the form, "The red Balmer line splits into (??) lines. In order of increasing frequency, they come from the transitions (1) $j = (??)$ to $j = (??)$, (2) $j = (??)$ to $j = (??)$, and so on. The frequency spacing between line (1) and line (2) is (??) Hz, the spacing between line (2) and line (3) is (??) Hz, and so on."

Problem 6.17 The *exact* fine-structure formula for hydrogen (obtained from the Dirac equation without recourse to perturbation theory) is¹¹

$$E_{nj} = mc^2 \left\{ \left[1 + \left(\frac{\alpha}{n - (j + 1/2) + \sqrt{(j + 1/2)^2 - \alpha^2}} \right)^2 \right]^{-1/2} - 1 \right\}.$$

Expand to order α^4 (noting that $\alpha \ll 1$), and show that you recover Equation 6.66.

6.4 THE ZEEMAN EFFECT

When an atom is placed in a uniform external magnetic field \mathbf{B}_{ext} , the energy levels are shifted. This phenomenon is known as the **Zeeman effect**. For a single electron, the perturbation is

$$H'_Z = -(\boldsymbol{\mu}_l + \boldsymbol{\mu}_s) \cdot \mathbf{B}_{\text{ext}}, \quad [6.67]$$

where

$$\boldsymbol{\mu}_s = -\frac{e}{m} \mathbf{S} \quad [6.68]$$

is the magnetic dipole moment associated with electron spin, and

$$\boldsymbol{\mu}_l = -\frac{e}{2m} \mathbf{L} \quad [6.69]$$

is the dipole moment associated with orbital motion.¹² Thus

$$H'_Z = \frac{e}{2m} (\mathbf{L} + 2\mathbf{S}) \cdot \mathbf{B}_{\text{ext}}. \quad [6.70]$$

The nature of the Zeeman splitting depends critically on the strength of the external field in comparison with the *internal* field (Equation 6.58) that gives rise to spin-orbit coupling. For if $B_{\text{ext}} \ll B_{\text{int}}$, then fine structure dominates, and H'_Z can be treated as a small perturbation, whereas if $B_{\text{ext}} \gg B_{\text{int}}$, then the Zeeman

¹¹Bethe and Salpeter (footnote 7) page 83.

¹²The gyromagnetic ratio for *orbital* motion is just the classical value ($q/2m$)—it is only for *spin* that there is an "extra" factor of 2.

effect dominates, and fine structure becomes the perturbation. In the intermediate zone, where the two fields are comparable, we need the full machinery of degenerate perturbation theory, and it is necessary to diagonalize the relevant portion of the Hamiltonian “by hand”. In the following sections we shall explore each of these regimes briefly, for the case of hydrogen.

Problem 6.18 Use Equation 6.58 to estimate the internal field in hydrogen, and characterize quantitatively a “strong” and “weak” Zeeman field.

6.4.1 Weak-Field Zeeman Effect

If $B_{\text{ext}} \ll B_{\text{int}}$, fine structure dominates (Equation 6.66); the “good” quantum numbers are n , l , j , and m_j (but not m_l and m_s , because—in the presence of spin-orbit coupling— \mathbf{L} and \mathbf{S} are not separately conserved). In first-order perturbation theory, the Zeeman correction to the energy is

$$E_Z^1 = \langle n l j m_j | H_Z' | n l j m_j \rangle = \frac{e}{2m} \mathbf{B}_{\text{ext}} \cdot \langle \mathbf{L} + 2\mathbf{S} \rangle. \quad [6.71]$$

Now $\mathbf{L} + 2\mathbf{S} = \mathbf{J} + \mathbf{S}$; unfortunately, we do not immediately know the expectation value of \mathbf{S} . But we can figure it out as follows: The total angular momentum $\mathbf{J} = \mathbf{L} + \mathbf{S}$ is constant (Figure 6.10); \mathbf{L} and \mathbf{S} precess rapidly about this fixed vector. In particular, the (time) *average* value of \mathbf{S} is just its projection along \mathbf{J} :

$$\mathbf{S}_{\text{ave}} = \frac{(\mathbf{S} \cdot \mathbf{J})}{J^2} \mathbf{J}. \quad [6.72]$$

But $\mathbf{L} = \mathbf{J} - \mathbf{S}$, so $L^2 = J^2 + S^2 - 2\mathbf{J} \cdot \mathbf{S}$, and hence

$$\mathbf{S} \cdot \mathbf{J} = \frac{1}{2}(J^2 + S^2 - L^2) = \frac{\hbar^2}{2}[j(j+1) + s(s+1) - l(l+1)], \quad [6.73]$$

from which it follows that

$$\langle \mathbf{L} + 2\mathbf{S} \rangle = \left\langle \left(1 + \frac{\mathbf{S} \cdot \mathbf{J}}{J^2} \right) \mathbf{J} \right\rangle = \left[1 + \frac{j(j+1) - l(l+1) + 3/4}{2j(j+1)} \right] \langle \mathbf{J} \rangle. \quad [6.74]$$

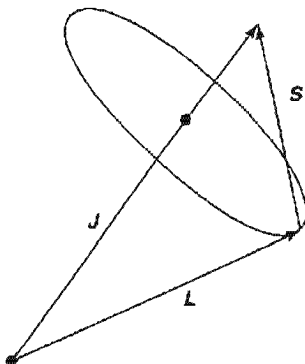

Figure 6.10: In the presence of spin-orbit coupling, \mathbf{L} and \mathbf{S} are not separately conserved; they precess about the fixed total angular momentum, \mathbf{J} .

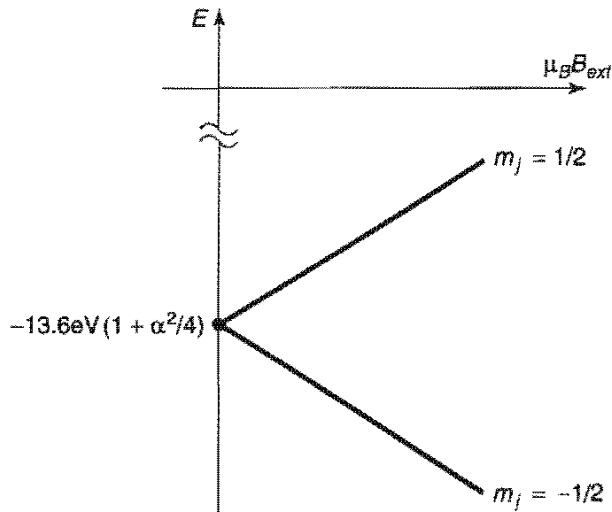

Figure 6.11: Weak-field Zeeman splitting of the ground state; the upper line ($m_j = 1/2$) has slope 1, the lower line ($m_j = -1/2$) has slope -1

The term in square brackets is known as the **Landé g-factor**, g_J .

We may as well choose the z -axis to lie along \mathbf{B}_{ext} ; then

$$E_Z^1 = \mu_B g_J B_{\text{ext}} m_j, \quad [6.75]$$

where

$$\mu_B \equiv \frac{e\hbar}{2m} = 5.788 \times 10^{-5} \text{ eV/T} \quad [6.76]$$

is the so-called **Bohr magneton**. The *total* energy is the sum of the fine-structure part (Equation 6.66) and the Zeeman contribution (Equation 6.75). For example, the ground state ($n = 1$, $l = 0$, $j = 1/2$, and therefore $g_J = 2$) splits into two levels:

$$-13.6 \text{ eV}(1 + \alpha^2/4) \pm \mu_B B_{\text{ext}}, \quad [6.77]$$

with the plus sign for $m_j = 1/2$, and minus for $m_j = -1/2$. These energies are plotted (as functions of B_{ext}) in Figure 6.11.

***Problem 6.19** Consider the (eight) $n = 2$ states, $|2 \ l \ j \ m_j\rangle$. Find the energy of each state, under weak-field Zeeman splitting, and construct a diagram like Figure 6.11 to show how the energies evolve as B_{ext} increases. Label each line clearly, and indicate its slope.

6.4.2 Strong-Field Zeeman Effect

If $B_{\text{ext}} \gg B_{\text{int}}$, the Zeeman effect dominates¹³; with B_{ext} in the z direction, the “good” quantum numbers are now n , l , m_l , and m_s (but not j and m_j because—in the presence of the external torque—the total angular momentum is not conserved, whereas L_z and

¹³In this regime the Zeeman effect is also known as the **Paschen-Back effect**.

S_z are). The Zeeman Hamiltonian is

$$H'_Z = \frac{e}{2m} B_{\text{ext}}(L_z + 2S_z),$$

and the “unperturbed” energies are

$$E_{nm_l m_s} = -\frac{13.6 \text{ eV}}{n^2} + \mu_B B_{\text{ext}}(m_l + 2m_s). \quad [6.78]$$

In first-order perturbation theory, the fine-structure correction to these levels is

$$E_{\text{fs}}^1 = \langle n l m_l m_s | (H'_r + H'_{so}) | n l m_l m_s \rangle. \quad [6.79]$$

The relativistic contribution is the same as before (Equation 6.56); for the spin-orbit term (Equation 6.60) we need

$$\langle \mathbf{S} \cdot \mathbf{L} \rangle = \langle S_x \rangle \langle L_x \rangle + \langle S_y \rangle \langle L_y \rangle + \langle S_z \rangle \langle L_z \rangle = \hbar^2 m_l m_s \quad [6.80]$$

(note that $\langle S_x \rangle = \langle S_y \rangle = \langle L_x \rangle = \langle L_y \rangle = 0$ for eigenstates of S_z and L_z). Putting all this together (Problem 6.20), we conclude that

$$E_{\text{fs}}^1 = \frac{13.6 \text{ eV}}{n^3} \alpha^2 \left\{ \frac{3}{4n} - \left[\frac{l(l+1) - m_l m_s}{l(l+1/2)(l+1)} \right] \right\}. \quad [6.81]$$

(The term in square brackets is indeterminate for $l = 0$; its correct value in this case is 1—see Problem 6.22.) The *total* energy is the sum of the Zeeman part (Equation 6.78) and the fine-structure contribution (Equation 6.81).

Problem 6.20 Starting with Equation 6.79 and using Equations 6.56, 6.60, 6.63, and 6.80, derive Equation 6.81.

****Problem 6.21** Consider the eight $n = 2$ states, $|2 l m_l m_s\rangle$. Find the energy of each state, under strong-field Zeeman splitting. (Express your answers as the sum of three terms, as in Equation 6.77: the Bohr energy; the fine structure, proportional to α^2 ; and the Zeeman contribution, proportional to $\mu_B B_{\text{ext}}$.) If you ignore fine structure altogether, how many distinct levels are there, and what are their degeneracies?

Problem 6.22 If $l = 0$, then $j = s$, $m_j = m_s$, and the “good” states are the same ($|n m_s\rangle$) for weak *and* strong fields. Determine E_Z^1 (from Equation 6.71) and the fine structure energies (Equation 6.66), and write down the general result for the $l = 0$ Zeeman effect—*regardless* of the strength of the field. Show that the strong-field formula (Equation 6.81) reproduces this result, provided that we interpret the indeterminate term in square brackets as 1.

6.4.3 Intermediate-Field Zeeman Effect

In the intermediate regime, neither H'_Z nor H'_{fs} dominates, and we must treat the two on an equal footing, as perturbations to the Bohr Hamiltonian (Equation 6.41):

$$H' = H'_Z + H'_{fs}. \quad [6.82]$$

I'll confine my attention here to the case $n = 2$ and choose as the basis for degenerate perturbation theory the states characterized by l , j , and m_j .¹⁴ Using the Clebsch-Gordan coefficients (Problem 4.45 or Table 4.7) to express $|j m_j\rangle$ as a linear combination of $|l m_l\rangle|s m_s\rangle$, we have

$$l = 0 \begin{cases} \psi_1 \equiv \left| \frac{1}{2} \frac{1}{2} \right\rangle = |00\rangle \left| \frac{1}{2} \frac{1}{2} \right\rangle, \\ \psi_2 \equiv \left| \frac{1}{2} \frac{-1}{2} \right\rangle = |00\rangle \left| \frac{1}{2} \frac{-1}{2} \right\rangle, \end{cases}$$

$$l = 1 \begin{cases} \psi_3 \equiv \left| \frac{3}{2} \frac{3}{2} \right\rangle = |11\rangle \left| \frac{1}{2} \frac{1}{2} \right\rangle, \\ \psi_4 \equiv \left| \frac{3}{2} \frac{-3}{2} \right\rangle = |1-1\rangle \left| \frac{1}{2} \frac{-1}{2} \right\rangle, \\ \psi_5 \equiv \left| \frac{3}{2} \frac{1}{2} \right\rangle = \sqrt{2/3}|10\rangle \left| \frac{1}{2} \frac{1}{2} \right\rangle + \sqrt{1/3}|11\rangle \left| \frac{1}{2} \frac{-1}{2} \right\rangle, \\ \psi_6 \equiv \left| \frac{1}{2} \frac{1}{2} \right\rangle = -\sqrt{1/3}|10\rangle \left| \frac{1}{2} \frac{1}{2} \right\rangle + \sqrt{2/3}|11\rangle \left| \frac{1}{2} \frac{-1}{2} \right\rangle, \\ \psi_7 \equiv \left| \frac{3}{2} \frac{-1}{2} \right\rangle = \sqrt{1/3}|1-1\rangle \left| \frac{1}{2} \frac{1}{2} \right\rangle + \sqrt{2/3}|10\rangle \left| \frac{1}{2} \frac{-1}{2} \right\rangle, \\ \psi_8 \equiv \left| \frac{1}{2} \frac{-1}{2} \right\rangle = -\sqrt{2/3}|1-1\rangle \left| \frac{1}{2} \frac{1}{2} \right\rangle + \sqrt{1/3}|10\rangle \left| \frac{1}{2} \frac{-1}{2} \right\rangle. \end{cases}$$

In this basis the nonzero matrix elements of H'_{fs} are all on the diagonal, and given by Equation 6.65; H'_Z has four off-diagonal elements, and the complete matrix $-W$ is (see Problem 6.23)

$$\begin{pmatrix} 5\gamma - \beta & 0 & 0 & 0 & 0 & 0 & 0 & 0 & 0 \\ 0 & 5\gamma + \beta & 0 & 0 & 0 & 0 & 0 & 0 & 0 \\ 0 & 0 & \gamma - 2\beta & 0 & 0 & 0 & 0 & 0 & 0 \\ 0 & 0 & 0 & \gamma + 2\beta & 0 & 0 & 0 & 0 & 0 \\ 0 & 0 & 0 & 0 & \gamma - \frac{2}{3}\beta & \frac{\sqrt{2}}{3}\beta & 0 & 0 & 0 \\ 0 & 0 & 0 & 0 & \frac{\sqrt{2}}{3}\beta & 5\gamma - \frac{1}{3}\beta & 0 & 0 & 0 \\ 0 & 0 & 0 & 0 & 0 & 0 & \gamma + \frac{2}{3}\beta & \frac{\sqrt{2}}{3}\beta & 0 \\ 0 & 0 & 0 & 0 & 0 & 0 & \frac{\sqrt{2}}{3}\beta & 5\gamma + \frac{1}{3}\beta & 0 \end{pmatrix}$$

where

$$\gamma \equiv (\alpha/8)^2 13.6 \text{ eV} \quad \text{and} \quad \beta \equiv \mu_B B_{\text{ext}}.$$

The first four eigenvalues are displayed along the diagonal; it remains only to find the eigenvalues of the two 2×2 blocks. The characteristic equation for the first is

$$\lambda^2 + \lambda(6\gamma - \beta) + (5\gamma^2 - \frac{11}{3}\gamma\beta) = 0,$$

¹⁴You can use l, m_l, m_s states if you prefer—this makes the matrix elements of H'_Z easier but those of H'_{fs} more difficult; the W -matrix will be more complicated, but its eigenvalues (which are independent of basis) are the same either way.

Table 6.2: Energy levels for the $n = 2$ states of hydrogen, with fine structure and Zeeman splitting.

| | |
|--------------|---|
| ϵ_1 | $= E_2 - 5\gamma + \beta$ |
| ϵ_2 | $= E_2 - 5\gamma - \beta$ |
| ϵ_3 | $= E_2 - \gamma + 2\beta$ |
| ϵ_4 | $= E_2 - \gamma - 2\beta$ |
| ϵ_5 | $= E_2 - 3\gamma + \beta/2 + \sqrt{4\gamma^2 + (2/3)\gamma\beta + \beta^2/4}$ |
| ϵ_6 | $= E_2 - 3\gamma + \beta/2 - \sqrt{4\gamma^2 + (2/3)\gamma\beta + \beta^2/4}$ |
| ϵ_7 | $= E_2 - 3\gamma - \beta/2 + \sqrt{4\gamma^2 - (2/3)\gamma\beta + \beta^2/4}$ |
| ϵ_8 | $= E_2 - 3\gamma - \beta/2 - \sqrt{4\gamma^2 - (2/3)\gamma\beta + \beta^2/4}$ |

and the quadratic formula gives the eigenvalues:

$$\lambda_{\pm} = -3\gamma + (\beta/2) \pm \sqrt{4\gamma^2 + (2/3)\gamma\beta + (\beta^2/4)}. \quad [6.83]$$

The eigenvalues of the second block are the same, but with the sign of β reversed. The eight energies are listed in Table 6.2, and plotted against B_{ext} in Figure 6.12. In the zero-field limit ($\beta = 0$) they reduce to the fine-structure values; for weak fields ($\beta \ll \gamma$) they reproduce what you got in Problem 6.19; for strong fields ($\beta \gg \gamma$) we recover the results of Problem 6.21 (note the convergence to five distinct energy levels, at very high fields, as predicted in Problem 6.21).

Problem 6.23 Work out the matrix elements of H'_Z and H'_{fs} , and construct the W -matrix given in the text, for $n = 2$.

*****Problem 6.24** Analyze the Zeeman effect for the $n = 3$ states of hydrogen in the weak, strong, and intermediate field regimes. Construct a table of energies (analogous

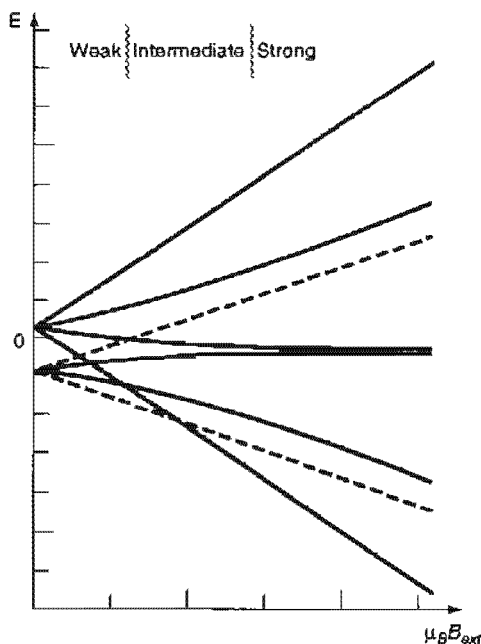

Figure 6.12: Zeeman splitting of the $n = 2$ states of hydrogen in the weak, intermediate, and strong field regimes.

to Table 6.2), plot them as functions of the external field (as in Figure 6.12), and check that the intermediate-field results reduce properly in the two limiting cases.

6.5 HYPERFINE SPLITTING

The proton itself constitutes a magnetic dipole, though its dipole moment is much smaller than the electron's because of the mass in the denominator (Equation 6.59):

$$\boldsymbol{\mu}_p = \frac{ge}{2m_p} \mathbf{S}_p, \quad \boldsymbol{\mu}_e = -\frac{e}{m_e} \mathbf{S}_e. \quad [6.84]$$

(The proton is a composite structure, made up of three quarks, and its gyromagnetic ratio is not as simple as the electron's—hence the g -factor,¹⁵ whose measured value is 5.59 as opposed to 2.00 for the electron.) According to classical electrodynamics, a dipole $\boldsymbol{\mu}$ sets up a magnetic field¹⁶

$$\mathbf{B} = \frac{\mu_0}{4\pi r^3} [3(\boldsymbol{\mu} \cdot \hat{\mathbf{r}})\hat{\mathbf{r}} - \boldsymbol{\mu}] + \frac{2\mu_0}{3} \boldsymbol{\mu} \delta^3(\mathbf{r}). \quad [6.85]$$

So the Hamiltonian (Equation 6.57) of the electron, in the magnetic field due to the proton's magnetic dipole moment, is

$$H'_{\text{hf}} = \frac{\mu_0 g e^2}{8\pi m_p m_e} \frac{[3(\mathbf{S}_p \cdot \hat{\mathbf{r}})(\mathbf{S}_e \cdot \hat{\mathbf{r}}) - \mathbf{S}_p \cdot \mathbf{S}_e]}{r^3} + \frac{\mu_0 g e^2}{3m_p m_e} \mathbf{S}_p \cdot \mathbf{S}_e \delta^3(\mathbf{r}). \quad [6.86]$$

According to perturbation theory, the first-order correction to the energy (Equation 6.9) is the expectation value of the perturbing Hamiltonian:

$$E_{\text{hf}}^1 = \frac{\mu_0 g e^2}{8\pi m_p m_e} \left\langle \frac{3(\mathbf{S}_p \cdot \hat{\mathbf{r}})(\mathbf{S}_e \cdot \hat{\mathbf{r}}) - \mathbf{S}_p \cdot \mathbf{S}_e}{r^3} \right\rangle + \frac{\mu_0 g e^2}{3m_p m_e} \langle \mathbf{S}_p \cdot \mathbf{S}_e \rangle |\psi(0)|^2. \quad [6.87]$$

In the ground state (or any other state for which $l = 0$) the wave function is spherically symmetrical, and the first expectation value vanishes (see Problem 6.25). Meanwhile, from Equation 4.80 we find that $|\psi_{100}(0)|^2 = 1/(\pi a^3)$, so

$$E_{\text{hf}}^1 = \frac{\mu_0 g e^2}{3\pi m_p m_e a^3} \langle \mathbf{S}_p \cdot \mathbf{S}_e \rangle, \quad [6.88]$$

¹⁵The Landé g -factor, in Equation 6.74, plays a similar role in the proportionality between the electron's *total* magnetic moment ($\boldsymbol{\mu}_l + \boldsymbol{\mu}_s$) and its total angular momentum \mathbf{J} .

¹⁶If you are unfamiliar with the delta function term in Equation 6.85, you can derive it by treating the dipole as a spinning charged spherical shell, in the limit as the radius goes to zero and the charge goes to infinity (with $\boldsymbol{\mu}$ held constant). See D. J. Griffiths, *Am. J. Phys.* **50**, 698 (1982).

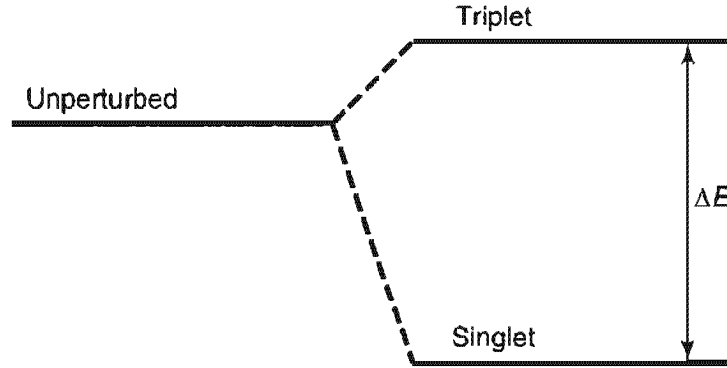

Figure 6.13: Hyperfine splitting in the ground state of hydrogen.

in the ground state. This is called **spin-spin coupling** because it involves the dot product of two spins (contrast spin-orbit coupling, which involves $\mathbf{S} \cdot \mathbf{L}$).

In the presence of spin-spin coupling, the individual spin angular momenta are no longer conserved; the “good” states are eigenvectors of the *total* spin,

$$\mathbf{S} \equiv \mathbf{S}_e + \mathbf{S}_p. \quad [6.89]$$

As before, we square this out to get

$$\mathbf{S}_p \cdot \mathbf{S}_e = \frac{1}{2}(S^2 - S_e^2 - S_p^2). \quad [6.90]$$

But the electron and proton both have spin $1/2$, so $S_e^2 = S_p^2 = (3/4)\hbar^2$. In the triplet state (spins “parallel”) the total spin is 1, and hence $S^2 = 2\hbar^2$; in the singlet state the total spin is 0, and $S^2 = 0$. Thus

$$E_{\text{hf}}^1 = \frac{4g\hbar^4}{3m_p m_e^2 c^2 a^4} \begin{cases} +1/4, & \text{(triplet);} \\ -3/4, & \text{(singlet).} \end{cases} \quad [6.91]$$

Spin-spin coupling breaks the spin degeneracy of the ground state, lifting the triplet configuration and depressing the singlet (see Figure 6.13).

The energy gap is evidently

$$\Delta E = \frac{4g\hbar^4}{3m_p m_e^2 c^2 a^4} = 5.88 \times 10^{-6} \text{ eV}. \quad [6.92]$$

The frequency of the photon emitted in a transition from the triplet to the singlet state is

$$\nu = \frac{\Delta E}{h} = 1420 \text{ MHz}, \quad [6.93]$$

and the corresponding wavelength is $c/\nu = 21 \text{ cm}$, which falls in the microwave region. This famous “21-centimeter line” is among the most pervasive and ubiquitous forms of radiation in the universe.

Problem 6.25 Let \mathbf{a} and \mathbf{b} be two constant vectors. Show that

$$\int (\mathbf{a} \cdot \hat{\mathbf{r}})(\mathbf{b} \cdot \hat{\mathbf{r}}) \sin \theta \, d\theta \, d\phi = \frac{4\pi}{3} (\mathbf{a} \cdot \mathbf{b}). \quad [6.94]$$

The integration is over the usual range: $0 < \theta < \pi$, $0 < \phi < 2\pi$. Use this result to demonstrate that

$$\left\langle \frac{3(\mathbf{S}_p \cdot \hat{\mathbf{r}})(\mathbf{S}_e \cdot \hat{\mathbf{r}}) - \mathbf{S}_p \cdot \mathbf{S}_e}{r^3} \right\rangle = 0,$$

for states with $l = 0$. *Hint:* $\hat{\mathbf{r}} = \sin \theta \cos \phi \hat{\mathbf{i}} + \sin \theta \sin \phi \hat{\mathbf{j}} + \cos \theta \hat{\mathbf{k}}$.

Problem 6.26 By appropriate modification of the hydrogen formula, determine the hyperfine splitting in the ground state of (a) muonic hydrogen (in which a muon—same charge and g -factor as the electron, but 207 times the mass—substitutes for the electron), (b) positronium (in which a positron—same mass and g -factor as the electron, but opposite charge—substitutes for the proton), and (c) muonium (in which an antimuon—same mass and g -factor as a muon, but opposite charge—substitutes for the proton). *Hint:* Don't forget to use the reduced mass (Problem 5.1) in calculating the "Bohr radius" of these exotic "atoms.". Incidentally, the answer you get for positronium (4.85×10^{-4} eV) is quite far from the experimental value (8.41×10^{-4} eV); the large discrepancy is due to pair annihilation ($e^+ + e^- \rightarrow \gamma + \gamma$), which contributes an extra $(3/4)\Delta E$ and does not occur (of course) in ordinary hydrogen, muonic hydrogen, or muonium. See Griffiths (footnote 16) for further details.

FURTHER PROBLEMS FOR CHAPTER 6

****Problem 6.27** Suppose the Hamiltonian H , for a particular quantum system, is a function of some parameter λ ; let $E_n(\lambda)$ and $\psi_n(\lambda)$ be the eigenvalues and eigenfunctions of $H(\lambda)$. The **Feynman-Hellmann theorem** states that

$$\frac{\partial E_n}{\partial \lambda} = \langle \psi_n | \frac{\partial H}{\partial \lambda} | \psi_n \rangle \quad [6.95]$$

(assuming either that E_n is nondegenerate, or—if degenerate—that the ψ_n 's are the "good" linear combinations of the degenerate eigenfunctions).

- (a) Prove the Feynman-Hellmann theorem. *Hint:* Use Equation 6.9.
- (b) Apply it to the one-dimensional harmonic oscillator, (i) using $\lambda = \omega$ (this yields a formula for the expectation value of V), (ii) using $\lambda = \hbar$ (this yields $\langle T \rangle$), and (iii) using $\lambda = m$ (this yields a relation between $\langle T \rangle$ and $\langle V \rangle$). Compare your answers to Problem 2.37 and the virial theorem predictions (Problem 3.53).

****Problem 6.28** The Feynman-Hellmann theorem (Problem 6.27) can be used to determine the expectation values of $1/r$ and $1/r^2$ for hydrogen.¹⁷ The effective Hamiltonian for the radial wave functions is (Equation 4.53)

$$H = -\frac{\hbar^2}{2m} \frac{d^2}{dr^2} + \frac{\hbar^2}{2m} \frac{l(l+1)}{r^2} - \frac{e^2}{4\pi\epsilon_0} \frac{1}{r},$$

and the eigenvalues (expressed in terms of l)¹⁸ are (Equation 4.70)

$$E_n = -\frac{me^4}{32\pi^2\epsilon_0^2\hbar^2(j_{\max} + l + 1)^2}.$$

- (a) Use $\lambda = e$ in the Feynman-Hellmann theorem to obtain $\langle 1/r \rangle$. Check your result against Equation 6.54.
- (b) Use $\lambda = l$ to obtain $\langle 1/r^2 \rangle$. Check your answer with Equation 6.55.

*****Problem 6.29** Prove **Kramers' relation**:

$$\frac{s+1}{n^2} \langle r^s \rangle - (2s+1)a \langle r^{s-1} \rangle + \frac{s}{4} [(2l+1)^2 - s^2] a^2 \langle r^{s-2} \rangle = 0, \quad [6.96]$$

which relates the expectation values of r to three different powers (s , $s-1$, and $s-2$), for an electron in the state ψ_{nlm} of hydrogen. *Hint*: Rewrite the radial equation (Equation 4.53) in the form

$$u'' = \left[\frac{l(l+1)}{r^2} - \frac{2}{ar} + \frac{1}{n^2 a^2} \right] u,$$

and use it to express $\int (ur^s u'') dr$ in terms of $\langle r^s \rangle$, $\langle r^{s-1} \rangle$, and $\langle r^{s-2} \rangle$. Then use integration by parts to reduce the second derivative. Show that $\int (ur^s u') dr = -(s/2) \langle r^{s-1} \rangle$, and $\int (u'r^s u') dr = -[2/(s+1)] \int (u'' r^{s+1} u') dr$. Take it from there.

Problem 6.30

- (a) Plug $s = 0$, $s = 1$, $s = 2$, and $s = 3$ into Kramers' relation (Equation 6.96) to obtain formulas for $\langle r^{-1} \rangle$, $\langle r \rangle$, $\langle r^2 \rangle$, and $\langle r^3 \rangle$. Note that you could continue indefinitely, to find *any* positive power.
- (b) In the *other* direction, however, you hit a snag. Put in $s = -1$, and show that all you get is a relation between $\langle r^{-2} \rangle$ and $\langle r^{-3} \rangle$.

¹⁷C. Sánchez del Río, *Am. J. Phys.*, **50**, 556 (1982); H. S. Valk, *Am. J. Phys.*, **54**, 921 (1986).

¹⁸In part (b) we treat l as a continuous variable; n becomes a function of l , according to Equation 4.67, because j_{\max} , which must be an integer, is fixed. To avoid confusion, I have eliminated n , to reveal the dependence on l explicitly.

- (c) But if you can get $\langle r^{-2} \rangle$ by some *other* means, you can apply the Kramers' relation to obtain the rest of the negative powers. Use Equation 6.55 (which is derived in Problem 6.28) to determine $\langle r^{-3} \rangle$, and check your answer against Equation 6.63.

*****Problem 6.31** When an atom is placed in a uniform external electric field \mathbf{E}_{ext} , the energy levels are shifted—a phenomenon known as the **Stark effect**. In this problem we analyze the Stark effect for the $n = 1$ and $n = 2$ states of hydrogen. Let the field point in the z direction, so the potential energy of the electron is

$$H'_S = -eE_{\text{ext}}z = -eE_{\text{ext}}r \cos \theta.$$

Treat this as a perturbation on the Bohr Hamiltonian (Equation 6.41); spin is irrelevant to this problem, so ignore it.

- (a) Show that the ground-state energy is not affected by this perturbation, in first order.
- (b) The first excited state is fourfold degenerate: ψ_{200} , ψ_{211} , ψ_{210} , ψ_{21-1} . Using degenerate perturbation theory, determine the first-order corrections to the energy. Into how many levels does E_2 split?
- (c) What are the “good” wave functions for part (b)? Find the expectation value of the electric dipole moment ($\mathbf{p}_e = -e\mathbf{r}$), in each of these “good” states. Notice that the results are independent of the applied field—evidently hydrogen in its first excited state can carry a *permanent* electric dipole moment.

Hint: There are a lot of integrals in this problem, but almost all of them are zero. So study each one carefully before you do any calculations: If the ϕ integral vanishes, there's not much point in doing the r and θ integrals! *Partial answer:* $W_{13} = W_{31} = 3eaE_{\text{ext}}$; all other elements are zero.

*****Problem 6.32** Consider the Stark effect (Problem 6.31) for the $n = 3$ states of hydrogen. There are initially nine degenerate states, ψ_{3lm} (neglecting spin, of course), and we turn on an electric field in the z direction.

- (a) Construct the 9×9 matrix representing the perturbing Hamiltonian. *Partial answer:* $\langle 3\ 0\ 0 | z | 3\ 1\ 0 \rangle = -3\sqrt{6}a$, $\langle 3\ 1\ 0 | z | 3\ 2\ 0 \rangle = -3\sqrt{3}a$, $\langle 3\ 1\ \pm 1 | z | 3\ 2\ \pm 1 \rangle = -(9/2)a$.
- (b) Find the eigenvalues and their degeneracies.

Problem 6.33 Calculate the wavelength, in centimeters, of the photon emitted under a hyperfine transition in the ground state ($n = 1$) of **deuterium**. Deuterium is “heavy” hydrogen, with an extra neutron in the nucleus. The proton and neutron bind together to form a **deuteron**, with spin 1 and magnetic moment

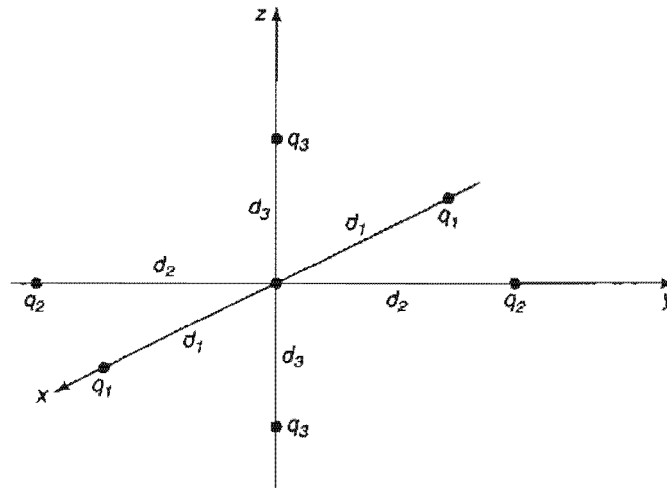

Figure 6.14: Hydrogen atom surrounded by six point charges (crude model for a crystal lattice); Problem 6.34.

$$\mu_d = \frac{g_d e}{2m_d} S_d;$$

the deuteron g -factor is 1.71.

*****Problem 6.34** In a crystal, the electric field of neighboring ions perturbs the energy levels of an atom. As a crude model, imagine that a hydrogen atom is surrounded by three pairs of point charges, as shown in Figure 6.14. (Spin is irrelevant to this problem, so ignore it.)

(a) Assuming that $r \ll d_1$, $r \ll d_2$, and $r \ll d_3$, show that

$$H' = V_0 + 3(\beta_1 x^2 + \beta_2 y^2 + \beta_3 z^2) - (\beta_1 + \beta_2 + \beta_3)r^2,$$

where

$$\beta_i \equiv -\frac{e}{4\pi\epsilon_0} \frac{q_i}{d_i^3}, \quad \text{and } V_0 = 2(\beta_1 d_1^2 + \beta_2 d_2^2 + \beta_3 d_3^2).$$

(b) Find the lowest-order correction to the ground-state energy.

(c) Calculate the first-order corrections to the energy of the first excited states ($n = 2$). Into how many levels does this fourfold degenerate system split, (i) in the case of **cubic symmetry**, $\beta_1 = \beta_2 = \beta_3$; (ii) in the case of **orthorhombic symmetry**, $\beta_1 = \beta_2 \neq \beta_3$; (iii) in the general case of **tetragonal symmetry** (all three different)?

CHAPTER 7

THE VARIATIONAL PRINCIPLE

7.1 THEORY

Suppose you want to calculate the ground-state energy E_g for a system described by the Hamiltonian H , but you are unable to solve the (time-independent) Schrödinger equation. Pick *any normalized function ψ whatsoever*.

Theorem:

$$E_g \leq \langle \psi | H | \psi \rangle \equiv \langle H \rangle. \quad [7.1]$$

That is, the expectation value of H in the (presumably incorrect) state ψ is certain to *overestimate* the ground-state energy. Of course, if ψ just happens to be one of the *excited* states, then *obviously* $\langle H \rangle$ exceeds E_g ; but the theorem says that the same holds for any ψ whatsoever.

Proof: Since the (unknown) eigenfunctions of H form a complete set, we can express ψ as a linear combination of them¹:

$$\psi = \sum_n c_n \psi_n, \quad \text{with } H\psi_n = E_n \psi_n.$$

¹If the Hamiltonian admits scattering states, as well as bound states, then we'll need an integral as well as a sum, but the argument is unchanged.

Since ψ is normalized,

$$1 = \langle \psi | \psi \rangle = \left\langle \sum_m c_m \psi_m \middle| \sum_n c_n \psi_n \right\rangle = \sum_m \sum_n c_m^* c_n \langle \psi_m | \psi_n \rangle = \sum_n |c_n|^2$$

(assuming the eigenfunctions have been orthonormalized: $\langle \psi_m | \psi_n \rangle = \delta_{mn}$). Meanwhile,

$$\langle H \rangle = \left\langle \sum_m c_m \psi_m \middle| H \sum_n c_n \psi_n \right\rangle = \sum_m \sum_n c_m^* E_n c_n \langle \psi_m | \psi_n \rangle = \sum_n E_n |c_n|^2.$$

But the ground-state energy is, by definition, the *smallest* eigenvalue, so $E_g \leq E_n$, and hence

$$\langle H \rangle \geq E_g \sum_n |c_n|^2 = E_g.$$

QED

Example 1. Suppose we want to find the ground-state energy for the one-dimensional harmonic oscillator:

$$H = -\frac{\hbar^2}{2m} \frac{d^2}{dx^2} + \frac{1}{2} m \omega^2 x^2.$$

Of course, we already know the *exact* answer, in this case (Equation 2.49): $E_g = (1/2)\hbar\omega$; but this makes it a good test of the method. We might pick as our “trial” wave function the gaussian,

$$\psi(x) = A e^{-bx^2}, \quad [7.2]$$

where b is a constant and A is determined by normalization:

$$1 = |A|^2 \int_{-\infty}^{\infty} e^{-2bx^2} dx = |A|^2 \sqrt{\frac{\pi}{2b}} \Rightarrow A = \left(\frac{2b}{\pi}\right)^{1/4}. \quad [7.3]$$

Now

$$\langle H \rangle = \langle T \rangle + \langle V \rangle, \quad [7.4]$$

where, in this case,

$$\langle T \rangle = -\frac{\hbar^2}{2m} |A|^2 \int_{-\infty}^{\infty} e^{-bx^2} \frac{d^2}{dx^2} (e^{-bx^2}) dx = \frac{\hbar^2 b}{2m}, \quad [7.5]$$

and

$$\langle V \rangle = \frac{1}{2} m \omega^2 |A|^2 \int_{-\infty}^{\infty} e^{-2bx^2} x^2 dx = \frac{m \omega^2}{8b},$$

so

$$\langle H \rangle = \frac{\hbar^2 b}{2m} + \frac{m \omega^2}{8b}. \quad [7.6]$$

According to the theorem, this exceeds E_g for any b ; to get the *tightest* bound let's *minimize* $\langle H \rangle$ with respect to b :

$$\frac{d}{db} \langle H \rangle = \frac{\hbar^2}{2m} - \frac{m\omega^2}{8b^2} = 0 \Rightarrow b = \frac{m\omega}{2\hbar}.$$

Putting this back into $\langle H \rangle$, we find

$$\langle H \rangle_{\min} = \frac{1}{2} \hbar \omega. \quad [7.7]$$

In this case we hit the ground-state energy right on the nose—because (obviously) it “just happened” to pick a trial function with precisely the form of the *actual* ground state (Equation 2.48). But the gaussian is very easy to work with, so it's a popular trial function even when it bears little resemblance to the true ground state.

Example 2. Suppose we're looking for the ground state energy of the delta-function potential:

$$H = -\frac{\hbar^2}{2m} \frac{d^2}{dx^2} - \alpha \delta(x).$$

Again, we already know the exact answer (Equation 2.109): $E_g = -m\alpha^2/2\hbar^2$. As before, we'll use a gaussian trial function (Equation 7.2). We've already determined the normalization and calculated $\langle T \rangle$; all we need is

$$\langle V \rangle = -\alpha |A|^2 \int_{-\infty}^{\infty} e^{-2bx^2} \delta(x) dx = -\alpha \sqrt{\frac{2b}{\pi}}.$$

Evidently,

$$\langle H \rangle = \frac{\hbar^2 b}{2m} - \alpha \sqrt{\frac{2b}{\pi}}, \quad [7.8]$$

and we know that this exceeds E_g for all b . Minimizing it,

$$\frac{d}{db} \langle H \rangle = \frac{\hbar^2}{2m} - \frac{\alpha}{\sqrt{2\pi b}} = 0 \Rightarrow b = \frac{2m^2 \alpha^2}{\pi \hbar^4}.$$

So

$$\langle H \rangle_{\min} = -\frac{m\alpha^2}{\pi \hbar^2}, \quad [7.9]$$

which is indeed somewhat higher than E_g , since $\pi > 2$.

I said you can use *any* (normalized) trial function ψ whatsoever, and this is true in a sense. However, for *discontinuous* functions it takes some fancy footwork to assign a sensible interpretation to the second derivative (which you need, in order to calculate $\langle T \rangle$). Continuous functions with kinks in them are fair game, however: the next example shows how to handle them.

Example 3. Find an upper bound on the ground-state energy of the one-dimensional infinite square well (Equation 2.15), using the “triangular” trial wave function (Figure 7.1)²:

$$\psi(x) = \begin{cases} Ax, & \text{if } 0 \leq x \leq a/2, \\ A(a-x), & \text{if } a/2 \leq x \leq a, \\ 0, & \text{otherwise,} \end{cases} \quad [7.10]$$

where A is determined by normalization:

$$1 = |A|^2 \left[\int_0^{a/2} x^2 dx + \int_{a/2}^a (a-x)^2 dx \right] = |A|^2 \frac{a^3}{12} \Rightarrow A = \frac{2}{a} \sqrt{\frac{3}{a}}. \quad [7.11]$$

In this case

$$\frac{d\psi}{dx} = \begin{cases} A, & \text{if } 0 \leq x \leq a/2, \\ -A, & \text{if } a/2 \leq x \leq a, \\ 0, & \text{otherwise,} \end{cases}$$

as indicated in Figure 7.2. Now, the derivative of a step function is a delta function (see Problem 2.24b):

$$\frac{d^2\psi}{dx^2} = A\delta(x) - 2A\delta(x - a/2) + A\delta(x - a), \quad [7.12]$$

and hence

$$\begin{aligned} \langle H \rangle &= -\frac{\hbar^2 A}{2m} \int [\delta(x) - 2\delta(x - a/2) + \delta(x - a)] \psi(x) dx \\ &= -\frac{\hbar^2 A}{2m} [\psi(0) - 2\psi(a/2) + \psi(a)] = \frac{\hbar^2 A^2 a}{2m} = \frac{12\hbar^2}{2ma^2}. \end{aligned} \quad [7.13]$$

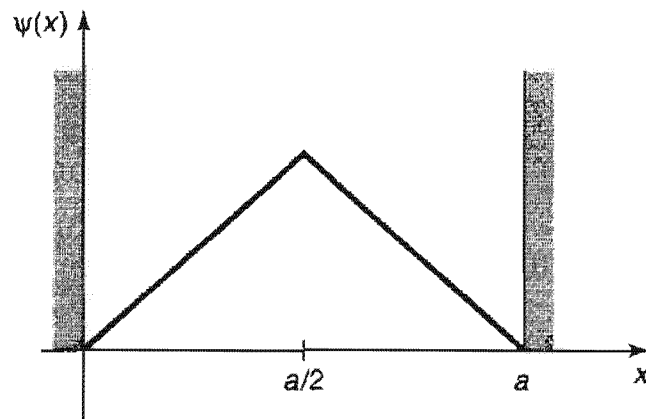

Figure 7.1: Triangular trial wave function for the infinite square well (Equation 7.10).

²There is no point in trying a function (such as the gaussian) that extends outside the well, because you’ll get $\langle V \rangle = \infty$, and Equation 7.1 tells you nothing.

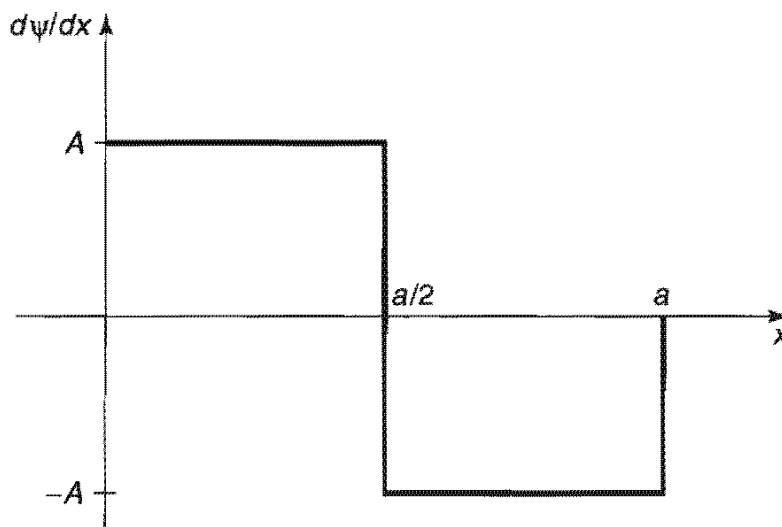

Figure 7.2: Derivative of the wave function in Figure 7.1.

The exact ground state is $E_g = \pi^2 \hbar^2 / 2ma^2$ (Equation 2.23), so the theorem works ($12 > \pi^2$).

The **variational principle** (as Equation 7.1 is called) is extremely powerful, and embarrassingly easy to use. What a chemist does, to find the ground-state energy of some complicated molecule, is write down a trial wave function with a large number of adjustable parameters, calculate $\langle H \rangle$, and tweak the parameters to get the lowest possible value. Even if ψ has no relation to the true wave function, one often gets miraculously accurate values for E_g . Naturally, if you have some way of guessing a *realistic* ψ , so much the better. The only *trouble* with the method is that you never know for sure how close you are to the target—all you can be *certain* of is that you've got an *upper bound*. Moreover, the technique applies only to the ground state (see, however, Problem 7.4).

***Problem 7.1** Use the gaussian trial function (Equation 7.2) to obtain the lowest upper bound you can on the ground-state energy of (a) the linear potential: $V(x) = \alpha|x|$; (b) the quartic potential: $V(x) = \alpha x^4$.

****Problem 7.2** Find the best bound on E_g for the one-dimensional harmonic oscillator using a trial wave function of the form

$$\psi(x) = \frac{A}{x^2 + b^2},$$

where A is determined by normalization and b is an adjustable parameter.

Problem 7.3 Find the best bound on E_g for the delta-function potential $-\alpha\delta(x - a/2)$, using the triangle trial function (Equation 7.10). (This time a is an adjustable parameter.)

Problem 7.4

- (a) Prove the following **corollary** to the variational principle: If $\langle \psi | \psi_g \rangle = 0$, then $\langle H \rangle \geq E_f$, where E_f is the energy of the first excited state.

Thus, if we can find a trial function that is orthogonal to the exact ground state, we can get an upper bound on the *first excited state*. In general, it's difficult to be sure that ψ is orthogonal to ψ_g , since (presumably) we don't *know* the latter. However, if the potential $V(x)$ is an *even* function of x , then the ground state is likewise even, and hence any *odd* trial function will automatically meet the condition for the corollary.

- (b) Find the best bound on the first excited state of the one-dimensional harmonic oscillator using the trial function

$$\psi(x) = Ax e^{-bx^2}.$$

Problem 7.5

- (a) Use the variational principle to prove that first-order nondegenerate perturbation theory always *overestimates* (or at any rate *never underestimates*) the ground-state energy.
- (b) In view of (a), you would expect that the *second-order* correction to the ground state is always negative. Confirm that this is indeed the case, by examining Equation 6.14.
-

7.2 THE GROUND STATE OF HELIUM

The helium atom (Figure 7.3) consists of two electrons in orbit around a nucleus containing two protons (also some neutrons, which are irrelevant to our purpose). The Hamiltonian for this system (ignoring fine structure and smaller corrections) is

$$H = -\frac{\hbar^2}{2m}(\nabla_1^2 + \nabla_2^2) - \frac{e^2}{4\pi\epsilon_0} \left(\frac{2}{r_1} + \frac{2}{r_2} - \frac{1}{|\mathbf{r}_1 - \mathbf{r}_2|} \right). \quad [7.14]$$

Our problem is to calculate the ground-state energy, E_g —the amount of energy it would take to strip off the two electrons. (Given E_g it is easy to figure out the “ionization energy” required to remove a *single* electron—see Problem 7.6.) E_g has been measured very accurately in the laboratory:

$$E_g = -78.975 \text{ eV} \quad (\text{experimental}). \quad [7.15]$$

This is the number we would like to reproduce theoretically.

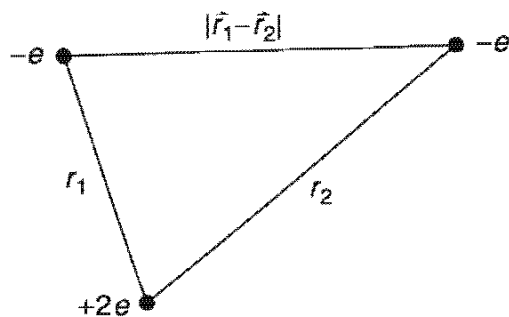

Figure 7.3: The helium atom.

It is curious that such a simple and important problem has no known exact solution.³ The trouble comes from the electron-electron repulsion,

$$V_{ee} = \frac{e^2}{4\pi\epsilon_0} \frac{1}{|\mathbf{r}_1 - \mathbf{r}_2|}. \quad [7.16]$$

If we ignore this term altogether, H splits into two independent hydrogen Hamiltonians (only with a nuclear charge of $2e$, instead of e); the exact solution is just the product of hydrogenic wave functions:

$$\psi_0(\mathbf{r}_1, \mathbf{r}_2) \equiv \psi_{100}(\mathbf{r}_1)\psi_{100}(\mathbf{r}_2) = \frac{8}{\pi a^3} e^{-2(r_1+r_2)/a}, \quad [7.17]$$

and the energy is $8E_1 = -109$ eV (Eq. [5.31]).⁴ This is a long way from -79 eV, but it's a start.

To get a better approximation for E_g , we'll apply the variational principle, using ψ_0 as the trial wave function. This is a particularly convenient choice because it's an eigenfunction of *most* of the Hamiltonian:

$$H\psi_0 = (8E_1 + V_{ee})\psi_0. \quad [7.18]$$

Thus

$$\langle H \rangle = 8E_1 + \langle V_{ee} \rangle, \quad [7.19]$$

where⁵

$$\langle V_{ee} \rangle = \left(\frac{e^2}{4\pi\epsilon_0} \right) \left(\frac{8}{\pi a^3} \right)^2 \int \frac{e^{-4(r_1+r_2)/a}}{|\mathbf{r}_1 - \mathbf{r}_2|} d^3\mathbf{r}_1 d^3\mathbf{r}_2. \quad [7.20]$$

³There do exist exactly soluble three-body problems with many of the qualitative features of helium, but using non-Coulombic potentials (see Problem 7.15).

⁴Here a is the ordinary Bohr radius and $E_n = -13.6/n^2$ eV is the n th Bohr energy; recall that for a nucleus with atomic number Z , $E_n \rightarrow Z^2 E_n$ and $a \rightarrow a/Z$ (Problem 4.17). The spin configuration associated with Equation 7.17 will be antisymmetric (the singlet).

⁵You can, if you like, interpret Equation 7.19 as first-order perturbation theory, with V_{ee} as H' . However, I regard this as a misuse of the method, since the perturbation is roughly equal in size to the unperturbed potential. I prefer, therefore, to think of it as a variational calculation, in which we are looking for an upper bound on E_g .

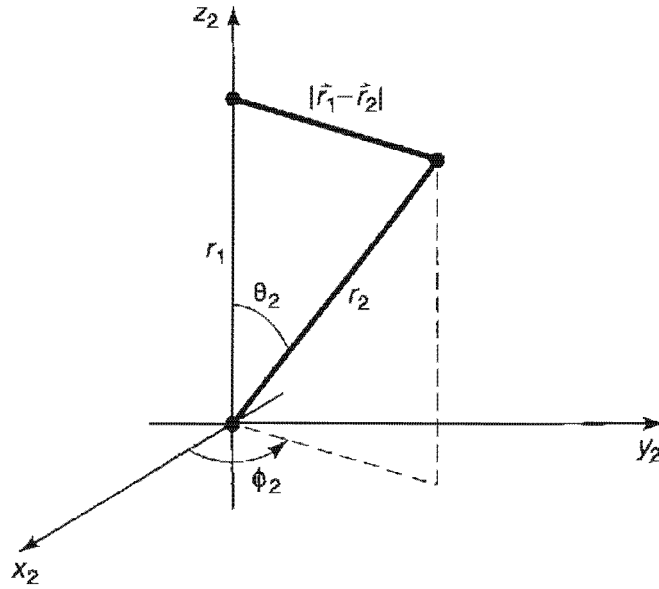

Figure 7.4: Choice of coordinates for the \mathbf{r}_2 integral (Equation 7.20).

I'll do the \mathbf{r}_2 integral first; for this purpose \mathbf{r}_1 is fixed, and we may as well orient the \mathbf{r}_2 coordinate system so that the polar axis lies along \mathbf{r}_1 (see Figure 7.4). By the law of cosines,

$$|\mathbf{r}_1 - \mathbf{r}_2| = \sqrt{r_1^2 + r_2^2 - 2r_1r_2 \cos \theta_2}, \quad [7.21]$$

and hence

$$I_2 \equiv \int \frac{e^{-4r_2/a}}{|\mathbf{r}_1 - \mathbf{r}_2|} d^3\mathbf{r}_2 = \int \frac{e^{-4r_2/a}}{\sqrt{r_1^2 + r_2^2 - 2r_1r_2 \cos \theta_2}} r_2^2 \sin \theta_2 dr_2 d\theta_2 d\phi_2. \quad [7.22]$$

The ϕ_2 integral is trivial (2π); the θ_2 integral is

$$\begin{aligned} \int_0^\pi \frac{\sin \theta_2}{\sqrt{r_1^2 + r_2^2 - 2r_1r_2 \cos \theta_2}} d\theta_2 &= \frac{\sqrt{r_1^2 + r_2^2 - 2r_1r_2 \cos \theta_2} \Big|_0^\pi}{r_1r_2} \\ &= \frac{1}{r_1r_2} \left(\sqrt{r_1^2 + r_2^2 + 2r_1r_2} - \sqrt{r_1^2 + r_2^2 - 2r_1r_2} \right) \\ &= \frac{1}{r_1r_2} [(r_1 + r_2) - |r_1 - r_2|] = \begin{cases} 2/r_1, & \text{if } r_2 < r_1, \\ 2/r_2, & \text{if } r_2 > r_1. \end{cases} \end{aligned} \quad [7.23]$$

Thus

$$\begin{aligned} I_2 &= 4\pi \left(\frac{1}{r_1} \int_0^{r_1} e^{-4r_2/a} r_2^2 dr_2 + \int_{r_1}^\infty e^{-4r_2/a} r_2 dr_2 \right) \\ &= \frac{\pi a^3}{8r_1} \left[1 - \left(1 + \frac{2r_1}{a} \right) e^{-4r_1/a} \right]. \end{aligned} \quad [7.24]$$

It follows that $\langle V_{ee} \rangle$ is equal to

$$\left(\frac{e^2}{4\pi\epsilon_0}\right) \left(\frac{8}{\pi a^3}\right) \int \left[1 - \left(1 + \frac{2r_1}{a}\right) e^{-4r_1/a}\right] e^{-4r_1/a} r_1 \sin\theta_1 dr_1 d\theta_1 d\phi_1.$$

The angular integrals are easy (4π), and the r_1 integral becomes

$$\int_0^\infty \left[r e^{-4r/a} - \left(r + \frac{2r^2}{a} \right) e^{-8r/a} \right] dr = \frac{5a^2}{128}.$$

Finally, then,

$$\langle V_{ee} \rangle = \frac{5}{4a} \left(\frac{e^2}{4\pi\epsilon_0}\right) = -\frac{5}{2} E_1 = 34 \text{ eV}, \quad [7.25]$$

and therefore

$$\langle H \rangle = -109 \text{ eV} + 34 \text{ eV} = -75 \text{ eV}. \quad [7.26]$$

Not bad (remember, the experimental value is -79 eV). But we can do better.

Can we think of a more realistic trial function than ψ_0 (which treats the two electrons as though they did not interact at all)? Rather than completely *ignoring* the influence of the other electron, let us say that, on the average, each electron represents a cloud of negative charge which partially *shields* the nucleus, so that the other electron actually sees an *effective* nuclear charge (Z) that is somewhat *less* than 2. This suggests that we use a trial function of the form

$$\psi_1(\mathbf{r}_1, \mathbf{r}_2) \equiv \frac{Z^3}{\pi a^3} e^{-Z(r_1+r_2)/a}. \quad [7.27]$$

We'll treat Z as a variational parameter, picking the value that minimizes $\langle H \rangle$.

This wave function is an eigenstate of the "unperturbed" Hamiltonian (neglecting electron repulsion), but with Z , instead of 2, in the Coulomb terms. With this in mind, we rewrite H (Equation 7.14) as follows:

$$\begin{aligned} H = & -\frac{\hbar^2}{2m} (\nabla_1^2 + \nabla_2^2) - \frac{e^2}{4\pi\epsilon_0} \left(\frac{Z}{r_1} + \frac{Z}{r_2} \right) \\ & + \frac{e^2}{4\pi\epsilon_0} \left(\frac{(Z-2)}{r_1} + \frac{(Z-2)}{r_2} + \frac{1}{|\mathbf{r}_1 - \mathbf{r}_2|} \right). \end{aligned} \quad [7.28]$$

The expectation value of H is evidently

$$\langle H \rangle = 2Z^2 E_1 + 2(Z-2) \left(\frac{e^2}{4\pi\epsilon_0}\right) \left\langle \frac{1}{r} \right\rangle + \langle V_{ee} \rangle. \quad [7.29]$$

Here $\langle 1/r \rangle$ is the expectation value of $1/r$ in the (one-particle) hydrogenic ground state ψ_{100} (but with nuclear charge Z); according to Equation 6.54,

$$\left\langle \frac{1}{r} \right\rangle = \frac{Z}{a}. \quad [7.30]$$

The expectation value of V_{ee} is the same as before (Equation 7.25), except that instead of $Z = 2$ we now want *arbitrary* Z —so we multiply a by $2/Z$:

$$\langle V_{ee} \rangle = \frac{5Z}{8a} \left(\frac{e^2}{4\pi\epsilon_0} \right) = -\frac{5Z}{4} E_1. \quad [7.31]$$

Putting all this together, we find

$$\langle H \rangle = [2Z^2 - 4Z(Z - 2) - (5/4)Z] E_1 = [-2Z^2 + (27/4)Z] E_1. \quad [7.32]$$

According to the variational principle, this quantity exceeds E_g for *any* value of Z . The *lowest* upper bound occurs when $\langle H \rangle$ is minimized:

$$\frac{d}{dZ} \langle H \rangle = [-4Z + (27/4)] E_1 = 0,$$

from which it follows that

$$Z = \frac{27}{16} = 1.69. \quad [7.33]$$

This is a reasonable result; it tells us that the other electron partially screens the nucleus, reducing its effective charge from 2 down to 1.69. Putting in this value for Z , we find

$$\langle H \rangle = \frac{1}{2} \left(\frac{3}{2} \right)^6 E_1 = -77.5 \text{ eV}. \quad [7.34]$$

The ground state of helium has been calculated with great precision in this way, using increasingly complicated trial wave functions with more and more adjustable parameters.⁶ But we're within 2% of the correct answer, and, frankly, at this point my own interest in the problem begins to fade.

Problem 7.6 Using $E_g = -79.0$ eV for the ground-state energy of helium, calculate the ionization energy (the energy required to remove just *one* electron). *Hint:* First calculate the ground-state energy of the helium ion, He^+ , with a single electron orbiting the nucleus; then subtract the two energies.

***Problem 7.7** Apply the techniques of this Section to the H^- and Li^+ ions (each has two electrons, like helium, but nuclear charges $Z = 1$ and $Z = 3$, respectively). Find the effective (partially shielded) nuclear charge, and determine the best upper bound on E_g , for each case. *Note:* In the case of H^- you should find that $\langle H \rangle > -13.6$ eV, which would appear to indicate that there is no bound state at all, since it is energetically favorable for one electron to fly off, leaving behind a neutral hydrogen atom. This is not entirely surprising, since the electrons are less strongly attracted to the nucleus than they are in helium, and the electron repulsion tends to break the atom apart. However, it turns out to be incorrect. With a more sophisticated trial wave

⁶E. A. Hylleraas, *Z. Phys.* **65**, 209 (1930); C. L. Pekeris, *Phys. Rev.* **115**, 1216 (1959).

function (see Problem 7.16) it can be shown that $E_g < -13.6$ eV, and hence that a bound state does exist. It's only *barely* bound, however, and there are no excited bound states,⁷ so H^- has no discrete spectrum (all transitions are to and from the continuum). As a result, it is difficult to study in the laboratory, although it exists in great abundance on the surface of the sun.⁸

7.3 THE HYDROGEN MOLECULE ION

Another classic application of the variational principle is to the hydrogen molecule ion, H_2^+ , consisting of a single electron in the Coulomb field of two protons (Figure 7.5). We shall assume for the moment that the protons are fixed in position, a specified distance R apart, although one of the most interesting byproducts of the calculation is going to be the actual *value* of R . The Hamiltonian is

$$H = -\frac{\hbar^2}{2m}\nabla^2 - \frac{e^2}{4\pi\epsilon_0}\left(\frac{1}{r_1} + \frac{1}{r_2}\right), \quad [7.35]$$

where r_1 and r_2 are the distances to the electron from the respective protons. As always, the strategy will be to guess a reasonable trial wave function, and invoke the variational principle to get a bound on the ground-state energy. (Actually, our main interest is in finding out whether this system bonds at *all*—that is, whether its energy is less than that of a neutral hydrogen atom plus a free proton. If our trial wave function indicates that there *is* a bound state, a *better* trial function can only make the bonding even stronger.)

To construct the trial wave function, imagine that the ion is formed by taking a hydrogen atom in its ground state (Equation 4.80),

$$\psi_g(\mathbf{r}) = \frac{1}{\sqrt{\pi a^3}} e^{-r/a}, \quad [7.36]$$

and then bringing in a proton from far away and nailing it down a distance R away. If R is substantially greater than the Bohr radius, a , the electron's wave function

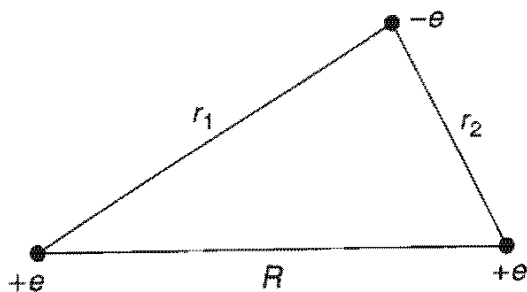

Figure 7.5: The hydrogen molecule ion, H_2^+ .

⁷Robert N. Hill, *J. Math. Phys.* **18**, 2316 (1977).

⁸For further discussion, see Hans A. Bethe and Edwin E. Salpeter, *Quantum Mechanics of One- and Two-Electron Atoms* (New York: Plenum 1977), Section 34.

probably isn't changed very much. But we would like to treat the two protons on an equal footing, so that the electron has the same probability of being associated with either one. This suggests that we consider a trial function of the form

$$\psi = A [\psi_g(r_1) + \psi_g(r_2)]. \quad [7.37]$$

(Quantum chemists call this the **LCAO** technique, because we are expressing the *molecular* wave function as a *linear combination* of *atomic orbitals*.)

Our first task is to *normalize* the trial function:

$$1 = \int |\psi|^2 d^3\mathbf{r} = |A|^2 \left[\int |\psi_g(r_1)|^2 d^3\mathbf{r} + \int |\psi_g(r_2)|^2 d^3\mathbf{r} + 2 \int \psi_g(r_1)\psi_g(r_2) d^3\mathbf{r} \right]. \quad [7.38]$$

The first two integrals are 1 (since ψ_g itself is normalized); the third is more tricky. Let

$$I \equiv \langle \psi_g(r_1) | \psi_g(r_2) \rangle = \frac{1}{\pi a^3} \int e^{-(r_1+r_2)/a} d^3\mathbf{r}. \quad [7.39]$$

Picking coordinates so that proton 1 is at the origin and proton 2 is on the z-axis at the point R (Figure 7.6), we have

$$r_1 = r \text{ and } r_2 = \sqrt{r^2 + R^2 - 2rR \cos \theta}, \quad [7.40]$$

and therefore

$$I = \frac{1}{\pi a^3} \int e^{-r/a} e^{-\sqrt{r^2 + R^2 - 2rR \cos \theta}/a} r^2 \sin \theta dr d\theta d\phi. \quad [7.41]$$

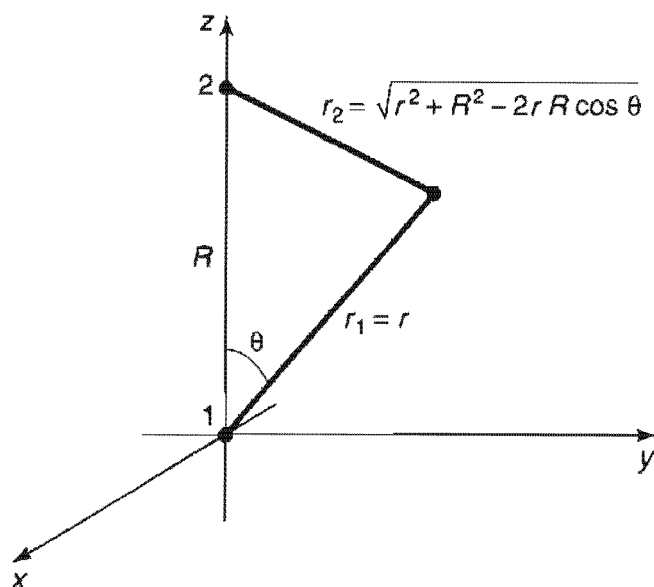

Figure 7.6: Coordinates for the calculation of I (Equation 7.39).

The ϕ integral is trivial (2π). To do the θ integral, let

$$y \equiv \sqrt{r^2 + R^2 - 2rR \cos \theta}, \text{ so that } d(y^2) = 2y dy = 2rR \sin \theta d\theta.$$

Then

$$\begin{aligned} \int_0^\pi e^{-\sqrt{r^2 + R^2 - 2rR \cos \theta}/a} \sin \theta d\theta &= \frac{1}{rR} \int_{|r-R|}^{r+R} e^{-y/a} y dy \\ &= -\frac{a}{rR} \left[e^{-(r+R)/a} (r+R+a) - e^{-|r-R|/a} (|r-R|+a) \right]. \end{aligned}$$

The r integral is now straightforward:

$$\begin{aligned} I &= \frac{2}{a^2 R} \left[-e^{-R/a} \int_0^\infty (r+R+a) e^{-2r/a} r dr + e^{-R/a} \int_0^R (R-r+a) r dr \right. \\ &\quad \left. + e^{R/a} \int_R^\infty (r-R+a) e^{-2r/a} r dr \right]. \end{aligned}$$

Evaluating the integrals, we find (after some algebraic simplification),

$$I = e^{-R/a} \left[1 + \left(\frac{R}{a} \right) + \frac{1}{3} \left(\frac{R}{a} \right)^2 \right]. \quad [7.42]$$

I is called an **overlap** integral; it measures the amount by which $\psi_g(r_1)$ overlaps $\psi_g(r_2)$ (notice that it goes to 1 as $R \rightarrow 0$, and to 0 as $R \rightarrow \infty$). In terms of I , the normalization factor (Equation 7.38) is

$$|A|^2 = \frac{1}{2(1+I)}. \quad [7.43]$$

Next we must calculate the expectation value of H in the trial state ψ . Noting that

$$\left(-\frac{\hbar^2}{2m} \nabla^2 - \frac{e^2}{4\pi\epsilon_0 r_1} \right) \psi_g(r_1) = E_1 \psi_g(r_1)$$

(where $E_1 = -13.6$ eV is the ground-state energy of atomic hydrogen)—and the same with r_2 in place of r_1 —we have

$$\begin{aligned} H\psi &= A \left[-\frac{\hbar^2}{2m} \nabla^2 - \frac{e^2}{4\pi\epsilon_0} \left(\frac{1}{r_1} + \frac{1}{r_2} \right) \right] [\psi_g(r_1) + \psi_g(r_2)] \\ &= E_1 \psi - A \left(\frac{e^2}{4\pi\epsilon_0} \right) \left[\frac{1}{r_2} \psi_g(r_1) + \frac{1}{r_1} \psi_g(r_2) \right]. \end{aligned}$$

It follows that

$$\langle H \rangle = E_1 - 2|A|^2 \left(\frac{e^2}{4\pi\epsilon_0} \right) \left[\langle \psi_g(r_1) | \frac{1}{r_2} | \psi_g(r_1) \rangle + \langle \psi_g(r_1) | \frac{1}{r_1} | \psi_g(r_2) \rangle \right]. \quad [7.44]$$

I'll let you calculate the two remaining quantities, the so-called **direct integral**,

$$D \equiv a \left\langle \psi_g(r_1) \left| \frac{1}{r_2} \right| \psi_g(r_1) \right\rangle, \quad [7.45]$$

and the **exchange integral**,

$$X \equiv a \left\langle \psi_g(r_1) \left| \frac{1}{r_1} \right| \psi_g(r_2) \right\rangle. \quad [7.46]$$

The results (see Problem 7.8) are

$$D = \frac{a}{R} - \left(1 + \frac{a}{R}\right) e^{-2R/a} \quad [7.47]$$

and

$$X = \left(1 + \frac{R}{a}\right) e^{-R/a}. \quad [7.48]$$

Putting all this together, and recalling (Equations 4.70 and 4.72) that $E_1 = -(e^2/4\pi\epsilon_0)(1/2a)$, we conclude that

$$\langle H \rangle = \left[1 + 2 \frac{(D + X)}{(1 + I)} \right] E_1. \quad [7.49]$$

According to the variational principle, the ground-state energy is *less* than $\langle H \rangle$. Of course, this is only the *electron's* energy—there is also potential energy associated with the proton-proton repulsion:

$$V_{pp} = \frac{e^2}{4\pi\epsilon_0} \frac{1}{R} = -\frac{2a}{R} E_1. \quad [7.50]$$

Thus the *total* energy of the system, in units of $-E_1$ and expressed as a function of $x \equiv R/a$, is less than

$$F(x) = -1 + \frac{2}{x} \left\{ \frac{(1 - (2/3)x^2)e^{-x} + (1 + x)e^{-2x}}{1 + (1 + x + (1/3)x^2)e^{-x}} \right\}. \quad [7.51]$$

This function is plotted in Figure 7.7. Evidently bonding *does* occur, for there exists a region in which the graph goes below -1 , indicating that the energy is less than that of a neutral atom plus a free proton (to wit, -13.6 eV). The equilibrium separation of the protons is about 2.4 Bohr radii, or 1.27 Å.

***Problem 7.8** Evaluate D and X (Equations 7.45 and 7.46). Check your answers against Equations 7.47 and 7.48.

****Problem 7.9** Suppose we used a *minus* sign in our trial wave function (Equation 7.37):

$$\psi = A[\psi_g(r_1) - \psi_g(r_2)]. \quad [7.52]$$

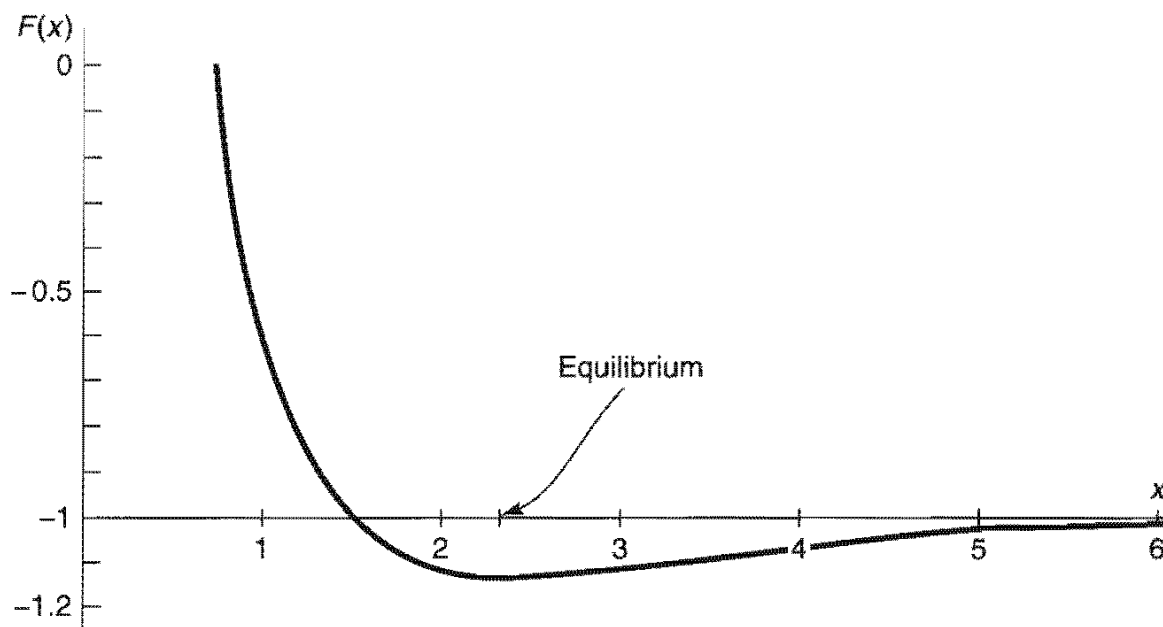

Figure 7.7: Plot of the function $F(x)$, Equation 7.51, showing existence of a bound state.

Without doing any new integrals, find $F(x)$ (the analog to Equation 7.51) for this case, and construct the graph. Show that there is no evidence of bonding. (Since the variational principle only gives an *upper bound*, this doesn't *prove* that bonding cannot occur for such a state, but it certainly doesn't look promising). *Note*: Actually, any function of the form

$$\psi = A[\psi_g(r_1) + e^{i\phi}\psi_g(r_2)] \quad [7.53]$$

has the desired property that the electron is equally likely to be associated with either proton. However, since the Hamiltonian (Equation 7.35) is invariant under the interchange $P:r_1 \leftrightarrow r_2$, its eigenfunctions can be chosen to be simultaneously eigenfunctions of P . The plus sign (Equation 7.37) goes with the eigenvalue $+1$, and the minus sign (Equation 7.52) with the eigenvalue -1 ; nothing is to be gained by considering the ostensibly more general case (Equation 7.53), though you're welcome to try it, if you're interested.

*****Problem 7.10** The second derivative of $F(x)$, at the equilibrium point, can be used to estimate the natural frequency of vibration (ω) of the two protons in the hydrogen molecule ion (see Section 2.3). If the ground-state energy ($\hbar\omega/2$) of this oscillator exceeds the binding energy of the system, it will fly apart. Show that in fact the oscillator energy is small enough that this will not happen, and estimate how many bound vibrational levels there are. *Note*: You're not going to be able to obtain the position of the minimum—still less the second derivative at that point—analytically. Do it numerically, on a computer.

FURTHER PROBLEMS FOR CHAPTER 7

Problem 7.11 Find the lowest bound on the ground state of hydrogen you can get using a gaussian trial wave function

$$\psi(\mathbf{r}) = Ae^{-br^2},$$

where A is determined by normalization and b is an adjustable parameter. *Answer:* -11.5 eV.

****Problem 7.12** If the photon had a nonzero mass ($m_\gamma \neq 0$), the Coulomb potential would be replaced by a **Yukawa potential**, of the form

$$V(\mathbf{r}) = -\frac{e^2}{4\pi\epsilon_0} \frac{e^{-\mu r}}{r}, \quad [7.54]$$

where $\mu = m_\gamma c/\hbar$. With a trial wave function of your own devising, estimate the binding energy of a “hydrogen” atom with this potential. Assume $\mu a \ll 1$, and give your answer correct to order $(\mu a)^2$.

Problem 7.13 Suppose you’re given a quantum system whose Hamiltonian H_0 admits just two eigenstates, ψ_a (with energy E_a), and ψ_b (with energy E_b). They are orthogonal, normalized, and nondegenerate (assume E_a is the smaller of the two). Now we turn on a perturbation H' , with the following matrix elements:

$$\langle \psi_a | H' | \psi_a \rangle = \langle \psi_b | H' | \psi_b \rangle = 0; \quad \langle \psi_a | H' | \psi_b \rangle = \langle \psi_b | H' | \psi_a \rangle = h. \quad [7.55]$$

- (a) Find the exact eigenvalues of the perturbed Hamiltonian.
- (b) Estimate the energies of the perturbed system using second-order perturbation theory.
- (c) Estimate the ground-state energy of the perturbed system using the variational principle, with a trial function of the form

$$\psi = (\cos \phi)\psi_a + (\sin \phi)\psi_b, \quad [7.56]$$

where ϕ is an adjustable parameter. (Note that writing the linear combination in this way guarantees that ψ is normalized.)

- (d) Compare your answers to (a), (b), and (c). Why is the variational principle so accurate in this case?

Problem 7.14 As an explicit example of the method developed in Problem 7.13, consider an electron at rest in a uniform magnetic field $\mathbf{B} = B_z \hat{k}$, for which the Hamiltonian is (Equation 4.158):

$$H_0 = \frac{eB_z}{m} S_z. \quad [7.57]$$

The eigenspinors, χ_a and χ_b , and the corresponding energies, E_a and E_b , are given in Equation 4.161. Now we turn on a perturbation, in the form of a uniform field in the x direction:

$$H' = \frac{eB_x}{m} S_x. \quad [7.58]$$

- Find the matrix elements of H' , and confirm that they have the structure of Equation 7.55. What is h ?
- Using your result in Problem 7.13(b), find the new ground-state energy, in second-order perturbation theory.
- Using your result in Problem 7.13(c), find the variational principle bound on the ground-state energy.

*****Problem 7.15** Although the Schrödinger equation for helium itself cannot be solved exactly, there exist “helium like” systems that do admit exact solutions. A simple example⁹ is “rubber-band helium”, in which the Coulomb forces are replaced by Hooke’s law forces:

$$H = -\frac{\hbar^2}{2m}(\nabla_1^2 + \nabla_2^2) + \frac{1}{2}m\omega^2(r_1^2 + r_2^2) - \frac{\lambda}{4}m\omega^2|\mathbf{r}_1 - \mathbf{r}_2|^2. \quad [7.59]$$

- Show that the change of variables from $\mathbf{r}_1, \mathbf{r}_2$, to

$$\mathbf{u} \equiv \frac{1}{\sqrt{2}}(\mathbf{r}_1 + \mathbf{r}_2), \quad \mathbf{v} \equiv \frac{1}{\sqrt{2}}(\mathbf{r}_1 - \mathbf{r}_2) \quad [7.60]$$

turns the Hamiltonian into two independent three-dimensional harmonic oscillators:

$$H = \left[-\frac{\hbar^2}{2m}\nabla_u^2 + \frac{1}{2}m\omega^2 u^2 \right] + \left[-\frac{\hbar^2}{2m}\nabla_v^2 + \frac{1}{2}(1-\lambda)m\omega^2 v^2 \right]. \quad [7.61]$$

- What is the *exact* ground-state energy for this system?
- If we didn’t know the exact solution, we might be inclined to apply the method of Section 7.2 to the Hamiltonian in its original form (Equation 7.59). Do so (but don’t bother with shielding). How does your result compare with the exact answer? *Answer:* $\langle H \rangle = 3\hbar\omega(1 - \lambda/4)$.

*****Problem 7.16** In Problem 7.7 we found that the trial wave function with shielding (Equation 7.27), which worked well for helium, is inadequate to confirm the existence

⁹For a more sophisticated model, see R. Crandall, R. Whinnell, and R. Bettega, *Am. J. Phys.* **52**, 438 (1984).

of a bound state for the negative hydrogen ion. Chandrasekhar¹⁰ used a trial wave function of the form

$$\psi(\mathbf{r}_1, \mathbf{r}_2) \equiv A[\psi_1(r_1)\psi_2(r_2) + \psi_2(r_1)\psi_1(r_2)], \quad [7.62]$$

where

$$\psi_1(r) \equiv \sqrt{\frac{Z_1^3}{\pi a^3}} e^{-Z_1 r/a}, \text{ and } \psi_2(r) \equiv \sqrt{\frac{Z_2^3}{\pi a^3}} e^{-Z_2 r/a}. \quad [7.63]$$

In effect, he allowed two *different* shielding factors, suggesting that one electron is relatively close to the nucleus and the other is farther out. (Because electrons are identical particles, the spatial wave function must be symmetrized with respect to interchange. The *spin* state—which is irrelevant to the calculation—is evidently antisymmetric.) Show that by astute choice of the adjustable parameters Z_1 and Z_2 you can get $\langle H \rangle$ less than -13.6 eV. *Answer:*

$$\langle H \rangle = \frac{E_1}{x^6 + y^6} \left(-x^8 + 2x^7 + \frac{1}{2}x^6y^2 - \frac{1}{2}x^5y^2 - \frac{1}{8}x^3y^4 + \frac{11}{8}xy^6 - \frac{1}{2}y^8 \right),$$

where $x \equiv Z_1 + Z_2$ and $y \equiv 2\sqrt{Z_1 Z_2}$. Chandrasekhar used $Z_1 = 1.039$ (since this is larger than 1, the motivating interpretation as an effective nuclear charge cannot be sustained, but never mind—it's still an acceptable trial wave function) and $Z_2 = 0.283$.

Problem 7.17 The fundamental problem in harnessing nuclear fusion is getting the two particles (say, two deuterons) close enough together for the attractive (but short-range) nuclear force to overcome the Coulomb repulsion. The “brute force” method is to heat the particles to fantastic temperatures and allow the random collisions to bring them together. A more exotic proposal is **muon catalysis**, in which we construct a “hydrogen molecule ion”, only with deuterons in place of protons, and a *muon* in place of the electron. Predict the equilibrium separation distance between the deuterons in such a structure, and explain why muons are superior to electrons for this purpose.¹¹

¹⁰S. Chandrasekhar, *Astrophys. J.* **100**, 176 (1944).

¹¹The classic paper on muon-catalyzed fusion is J. D. Jackson, *Phys. Rev.* **106**, 330 (1957); for a recent popular review, see J. Rafelski and S. Jones, *Scientific American*, November 1987, page 84.

CHAPTER 8

THE WKB APPROXIMATION

The **WKB** (Wentzel, Kramers, Brillouin)¹ method is a technique for obtaining approximate solutions to the time-independent Schrödinger equation in one dimension (the same basic idea can be applied to many other differential equations, and to the radial part of the Schrödinger equation in three dimensions). It is particularly useful in calculating bound-state energies and tunneling rates through potential barriers.

The essential idea is as follows: Imagine a particle of energy E moving through a region where the potential $V(x)$ is *constant*. If $E > V$, the wave function is of the form

$$\psi(x) = Ae^{\pm ikx}, \quad \text{with } k \equiv \sqrt{2m(E - V)}/\hbar.$$

The plus sign indicates that the particle is traveling to the right, and the minus sign means it is going to the left (the general solution, of course, is a linear combination of the two). The wave function is oscillatory, with constant wavelength $\lambda = 2\pi/k$ and constant amplitude A . Now suppose that $V(x)$ is *not* constant, but varies rather slowly in comparison to λ , so that over a region containing many full wavelengths the potential is *essentially* constant. Then it is reasonable to suppose that ψ remains *practically* sinusoidal, except that the wavelength and the amplitude change slowly with x . This is the inspiration behind the WKB approximation. In effect, it identifies two different levels of x -dependence: rapid oscillations, *modulated* by gradual variation in amplitude and wavelength.

¹In Holland it's KWB, in France it's BWK, and in England it's JWKB (for Jeffreys).

By the same token, if $E < V$ (and V is constant), then ψ is exponential:

$$\psi(x) = Ae^{\pm\kappa x}, \quad \text{with } \kappa \equiv \sqrt{2m(V - E)}/\hbar.$$

And if $V(x)$ is *not* constant, but varies slowly in comparison with $1/\kappa$, the solution remains *practically* exponential, except that A and κ are now slowly varying functions of x .

Now, there is one place where this whole program is bound to fail, and that is in the immediate vicinity of a classical **turning point**, where $E \approx V$. For here λ (or $1/\kappa$) goes to infinity, and $V(x)$ can hardly be said to vary “slowly” in comparison. As we shall see, a proper handling of the turning points is the most difficult aspect of the WKB approximation, though the final results are simple to state and easy to implement.

8.1 THE “CLASSICAL” REGION

The Schrödinger equation,

$$-\frac{\hbar^2}{2m} \frac{d^2\psi}{dx^2} + V(x)\psi = E\psi,$$

can be rewritten in the following way:

$$\frac{d^2\psi}{dx^2} = -\frac{p^2}{\hbar^2}\psi, \quad [8.1]$$

where

$$p(x) \equiv \sqrt{2m[E - V(x)]} \quad [8.2]$$

is the classical formula for the momentum of a particle with total energy E and potential energy $V(x)$. For the moment, I’ll assume that $E > V(x)$, so that $p(x)$ is *real*; we call this the “classical” region, for obvious reasons—classically the particle is *confined* to this range of x (see Figure 8.1). In general, ψ is some complex function; we can express it in terms of its *amplitude*, $A(x)$, and its *phase*, $\phi(x)$ —both of which are *real*:

$$\psi(x) = A(x)e^{i\phi(x)}. \quad [8.3]$$

Using a prime to denote the derivative with respect to x , we find

$$\frac{d\psi}{dx} = (A' + iA\phi')e^{i\phi},$$

and

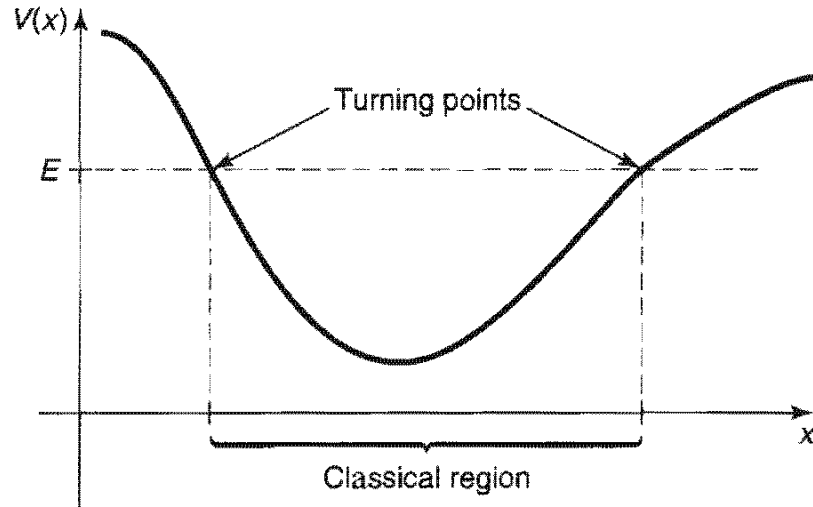

Figure 8.1: Classically, the particle is confined to the region where $E \geq V(x)$.

$$\frac{d^2\psi}{dx^2} = [A'' + 2iA'\phi' + iA\phi'' - A(\phi')^2]. \quad [8.4]$$

Putting this into Equation 8.1,

$$A'' + 2iA'\phi' + iA\phi'' - A(\phi')^2 = -\frac{p^2}{\hbar^2}A. \quad [8.5]$$

This is equivalent to two *real* equations, one for the real part and one for the imaginary part:

$$A'' - A(\phi')^2 = -\frac{p^2}{\hbar^2}A, \quad \text{or} \quad A'' = A \left[(\phi')^2 - \frac{p^2}{\hbar^2} \right], \quad [8.6]$$

and

$$2A'\phi' + A\phi'' = 0, \quad \text{or} \quad (A^2\phi')' = 0. \quad [8.7]$$

Equations 8.6 and 8.7 are entirely equivalent to the original Schrödinger equation. The second one is easily solved:

$$A^2\phi' = C^2, \quad \text{or} \quad A = \frac{C}{\sqrt{\phi'}}, \quad [8.8]$$

where C is a (real) constant. The first one (Equation 8.6) cannot be solved in general—so here comes the approximation: *We assume that the amplitude A varies slowly*, so that the A'' term is negligible. (More precisely, we assume that A''/A is much less than both $(\phi')^2$ and p^2/\hbar^2 .) In that case we can drop the left side of Equation 8.6, and we are left with

$$(\phi')^2 = \frac{p^2}{\hbar^2}, \quad \text{or} \quad \frac{d\phi}{dx} = \pm \frac{p}{\hbar},$$

and therefore

$$\phi(x) = \pm \frac{1}{\hbar} \int p(x) dx. \tag{8.9}$$

(I'll write this as an *indefinite* integral, for now—any constant of integration can be absorbed into C , which thereby becomes complex.) It follows, then, that

$$\psi(x) \cong \frac{C}{\sqrt{p(x)}} e^{\pm \frac{i}{\hbar} \int p(x) dx}, \tag{8.10}$$

and the general (approximate) solution will be a linear combination of two such terms, one with each sign.

Notice that

$$|\psi(x)|^2 \cong \frac{|C|^2}{p(x)}, \tag{8.11}$$

which says that the probability of finding the particle at point x is inversely proportional to its (classical) momentum (and hence its velocity) at that point. This is exactly what you would expect—the particle doesn't spend long in the places where it is moving rapidly, so the probability of getting caught there is small. In fact, the WKB approximation is sometimes *derived* by starting with this "semiclassical" observation, instead of by dropping the A'' term in the differential equation. The latter approach is cleaner mathematically, but the former offers a more plausible physical rationale.

Example: Potential well with two vertical walls. Suppose we have an infinite square well with a bumpy bottom (Figure 8.2):

$$V(x) = \begin{cases} \text{some specified function,} & \text{if } 0 < x < a, \\ \infty, & \text{otherwise.} \end{cases} \tag{8.12}$$

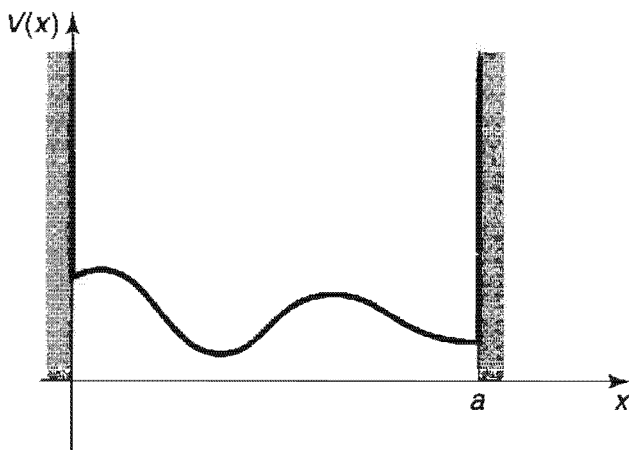

Figure 8.2: Infinite square well with a bumpy bottom.

Inside the well [assuming $E > V(x)$ throughout] we have

$$\psi(x) \cong \frac{1}{\sqrt{p(x)}} [C_+ e^{i\phi(x)} + C_- e^{-i\phi(x)}],$$

or, more conveniently,

$$\psi(x) \cong \frac{1}{\sqrt{p(x)}} [C_1 \sin \phi(x) + C_2 \cos \phi(x)], \quad [8.13]$$

where (exploiting the freedom noted earlier to impose a convenient lower limit on the integral)

$$\phi(x) = \frac{1}{\hbar} \int_0^x p(x') dx'. \quad [8.14]$$

Now $\psi(x)$ must go to zero at $x = 0$, so, since $\phi(0) = 0$, $C_2 = 0$. Also, $\psi(x)$ goes to zero at $x = a$, so

$$\phi(a) = n\pi \quad (n = 1, 2, 3 \dots). \quad [8.15]$$

Conclusion:

$$\int_0^a p(x) dx = n\pi\hbar. \quad [8.16]$$

This quantization condition is our main result; it determines the (approximate) allowed energies.

For instance, if the well has a *flat* bottom [$V(x) = 0$], then $p(x) = \sqrt{2mE}$ (a constant), and Equation 8.16 says $pa = n\pi\hbar$, or

$$E_n = \frac{n^2 \pi^2 \hbar^2}{2ma^2},$$

which are precisely the energy levels of the original infinite square well (Equation 2.23). In this case the WKB approximation yields the *exact* answer (the amplitude of the true wave function is *constant*, so dropping A'' cost us nothing).

***Problem 8.1** Use the WKB approximation to find the allowed energies (E_n) of an infinite square well with a “shelf”, of height V_0 , extending half-way across (see Figure 6.3):

$$V(x) = \begin{cases} V_0, & \text{if } 0 < x < a/2, \\ 0, & \text{if } a/2 < x < a, \\ \infty, & \text{otherwise.} \end{cases}$$

Express your answer in terms of V_0 and $E_n^0 \equiv (n\pi\hbar)^2/2ma^2$ (the n th allowed energy for the "unperturbed" infinite square well, with *no* shelf). Assume that $E_1^0 > V_0$, but do *not* assume that $E_n \gg V_0$. Compare your result with what we got in Section 6.1.2, using first-order perturbation theory. Note that they are in agreement if either V_0 is very small (the perturbation theory regime) or n is very large (the semiclassical WKB regime).

****Problem 8.2** An illuminating alternative derivation of the WKB formula (Equation 8.10) is based on an expansion in powers of \hbar . Motivated by the free particle wave function, $\psi = A \exp(\pm ipx/\hbar)$, we write

$$\psi(x) = e^{if(x)/\hbar},$$

where $f(x)$ is some *complex* function. (Note that there is no loss of generality here—any nonzero function can be written in this way.)

(a) Put this into Schrödinger's equation (in the form of Equation 8.1), and show that

$$i\hbar f'' - (f')^2 + p^2 = 0.$$

(b) Write $f(x)$ as a power series in \hbar :

$$f(x) = f_0(x) + \hbar f_1(x) + \hbar^2 f_2(x) + \cdots,$$

and, collecting like powers of \hbar , show that

$$(f_0')^2 = p^2, \quad if_0'' = 2f_0'f_1', \quad if_1'' = 2f_0'f_2' + (f_1')^2, \quad \text{etc.}$$

(c) Solve for $f_0(x)$ and $f_1(x)$, and show that—to first order in \hbar —you recover Equation 8.10.

Note: The logarithm of a negative number is defined by $\ln(-z) = \ln(z) + in\pi$, where n is an odd integer. If this formula is new to you, try exponentiating both sides, and you'll see where it comes from.

8.2 TUNNELING

So far, I have assumed that $E > V$, so that $p(x)$ is real. But we can easily write down the corresponding result in the *nonclassical* region ($E < V$)—it's the same as before (Equation 8.10), only now $p(x)$ is *imaginary*²:

$$\psi(x) \cong \frac{C}{\sqrt{|p(x)|}} e^{\pm \frac{1}{\hbar} \int |p(x)| dx}, \quad [8.17]$$

Consider, for example, the problem of scattering from a rectangular barrier with a bumpy top (Figure 8.3). To the left of the barrier ($x < 0$),

$$\psi(x) = Ae^{ikx} + Be^{-ikx}, \quad [8.18]$$

where A is the incident amplitude, B is the reflected amplitude, and $k \equiv \sqrt{2mE}/\hbar$ (see Section 2.7). To the right of the barrier ($x > a$),

$$\psi(x) = Fe^{ikx}; \quad [8.19]$$

F is the transmitted amplitude, and the tunneling probability is

$$T = \frac{|F|^2}{|A|^2}. \quad [8.20]$$

In the tunneling region ($0 \leq x \leq a$), the WKB approximation gives

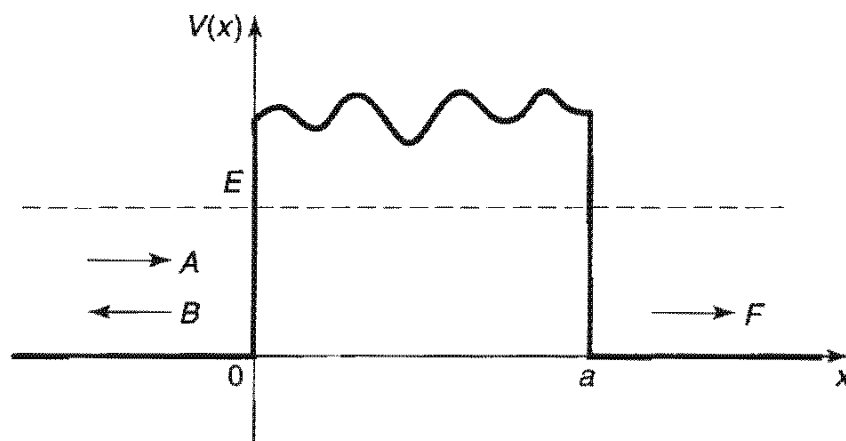

Figure 8.3: Scattering from a rectangular barrier with a bumpy top.

²In this case the wave function is *real*, and the analogs to Equations 8.6 and 8.7 do not follow *necessarily* from Equation 8.5, although they are still *sufficient*. If this bothers you, study the alternative derivation in Problem 8.2.

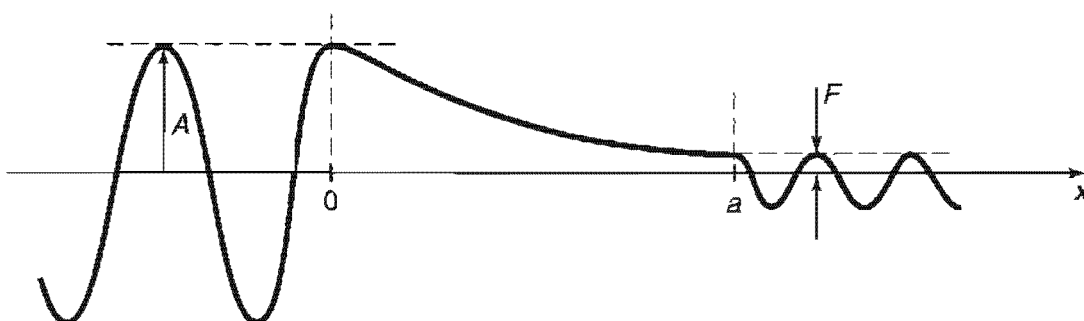

Figure 8.4: Qualitative structure of the wave function, for scattering from a high, broad barrier.

$$\psi(x) \cong \frac{C}{\sqrt{|p(x)|}} e^{\frac{1}{\hbar} \int_0^x |p(x')| dx'} + \frac{D}{\sqrt{|p(x)|}} e^{-\frac{1}{\hbar} \int_0^x |p(x')| dx'}. \quad [8.21]$$

But if the barrier is very high and/or very wide (which is to say, if the probability of tunneling is small), then the coefficient of the exponentially *increasing* term (C) must be small (in fact, it would be *zero* if the barrier were *infinitely* broad), and the wave function looks something like³ Figure 8.4. The relative amplitudes of the incident and transmitted waves are determined essentially by the total decrease of the exponential over the nonclassical region:

$$\frac{|F|}{|A|} \sim e^{-\frac{1}{\hbar} \int_0^a |p(x')| dx'},$$

so that

$$T \cong e^{-2\gamma}, \quad \text{with} \quad \gamma \equiv \frac{1}{\hbar} \int_0^a |p(x)| dx. \quad [8.22]$$

Example: Gamow's theory of alpha decay. In 1928, George Gamow (and, independently, Condon and Gurney) used this result to provide the first theoretical account of alpha decay (the spontaneous emission of an alpha particle—two protons and two neutrons—by certain radioactive nuclei). Since the alpha particle carries a positive charge ($2e$), it will be electrically repelled by the leftover nucleus (charge Ze) as soon as it gets far enough away to escape the nuclear binding force. Gamow pictured the potential energy curve for the alpha particle as a finite square well (representing the attractive nuclear force), extending out to r_1 (the radius of the nucleus), joined to a repulsive Coulombic tail (Figure 8.5). If E is the energy of the emitted alpha particle, the outer turning point (r_2) is determined by

³This heuristic argument can be made more rigorous—see Problem 8.10.

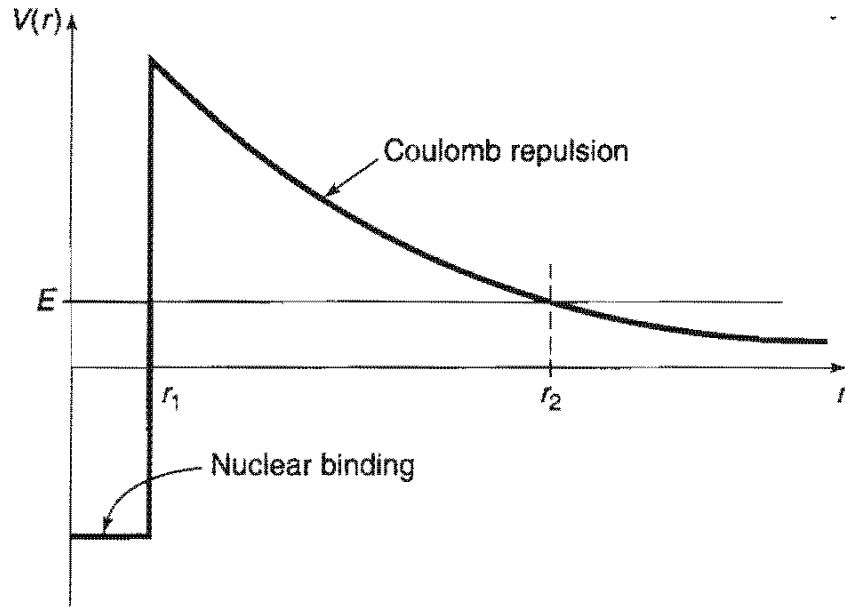

Figure 8.5: Gamow's model for the potential energy of an alpha particle in a radioactive nucleus.

$$\frac{1}{4\pi\epsilon_0} \frac{2Ze^2}{r_2} = E. \quad [8.23]$$

The exponent γ (Equation 8.22) is evidently⁴

$$\begin{aligned} \gamma &= \frac{1}{\hbar} \int_{r_1}^{r_2} \sqrt{2m \left(\frac{1}{4\pi\epsilon_0} \frac{2Ze^2}{r} - E \right)} dr = \frac{\sqrt{2mE}}{\hbar} \int_{r_1}^{r_2} \sqrt{\frac{r_2}{r} - 1} dr \\ &= \frac{\sqrt{2mE}}{\hbar} \left[r_2 \cos^{-1} \sqrt{r_1/r_2} - \sqrt{r_1(r_2 - r_1)} \right]. \end{aligned} \quad [8.24]$$

Typically, $r_1 \ll r_2$, and we can simplify this result. The argument of the inverse cosine is close to zero, so the angle itself is close to $\pi/2$. Call it $\theta = (\pi/2) - \epsilon$: then

$$\cos \theta = \cos(\pi/2) \cos \epsilon + \sin(\pi/2) \sin \epsilon \cong \sin \epsilon \cong \epsilon,$$

and hence

$$\cos^{-1} \sqrt{\frac{r_1}{r_2}} \cong \frac{\pi}{2} - \sqrt{\frac{r_1}{r_2}}.$$

⁴In this case the potential does not drop to zero on both sides of the barrier (moreover, this is really a three-dimensional problem), but the essential inspiration, contained in Equation 8.22, is all we really need.

Thus

$$\gamma \cong \frac{\sqrt{2mE}}{\hbar} \left[\frac{\pi}{2} r_2 - 2\sqrt{r_1 r_2} \right] = K_1 \frac{Z}{\sqrt{E}} - K_2 \sqrt{Z r_1}, \quad [8.25]$$

where

$$K_1 \equiv \left(\frac{e^2}{4\pi\epsilon_0} \right) \frac{\pi\sqrt{2m}}{\hbar} = 1.980 \text{ MeV}^{1/2}, \quad [8.26]$$

and

$$K_2 \equiv \left(\frac{e^2}{4\pi\epsilon_0} \right)^{1/2} \frac{4\sqrt{m}}{\hbar} = 1.485 \text{ fm}^{-1/2}. \quad [8.27]$$

(One fermi, fm, is 10^{-15} m, which is about the size of a typical nucleus.)

If we imagine the alpha particle rattling around inside the nucleus, with an average velocity v , the average time between “collisions” with the “wall” is about $2r_1/v$, and hence the *frequency* of collisions is $v/2r_1$. The probability of escape at each collision is $e^{-2\gamma}$, so the probability of emission, per unit time, is $(v/2r_1)e^{-2\gamma}$, and hence the **lifetime** of the parent nucleus is about

$$\tau = \frac{2r_1}{v} e^{2\gamma}. \quad [8.28]$$

Unfortunately, we don't know v —but it hardly matters, for the exponential factor varies over a *fantastic* range (25 orders of magnitude) as we go from one radioactive nucleus to another; relative to this the variation in v is pretty insignificant. In particular, if you plot the *logarithm* of the experimentally measured lifetime against $1/\sqrt{E}$ (related to γ by Equation 8.25), the result is a beautiful straight line (Figure 8.6), confirming that the lifetime of an alpha emitter is governed by the difficulty of penetrating the Coulomb barrier.

***Problem 8.3** Use Equation 8.22 to calculate the approximate transmission probability for a particle of energy E that encounters a finite square barrier of height $V_0 > E$ and width $2a$. Compare the exact result (Prob. 2.32) in the WKB regime $T \ll 1$.

****Problem 8.4** Calculate the lifetimes of U^{238} and Po^{212} , using Equation 8.28, with Equation 8.25 for γ . *Hint:* The density of nuclear matter is relatively constant (i.e., the same for all nuclei), so $(r_1)^3$ is proportional to A (the number of neutrons plus protons). Empirically,

$$r_1 \cong (1.07 \text{ fm}) A^{1/3}. \quad [8.29]$$

The energy of the emitted alpha particle is determined by Einstein's formula ($E = mc^2$):

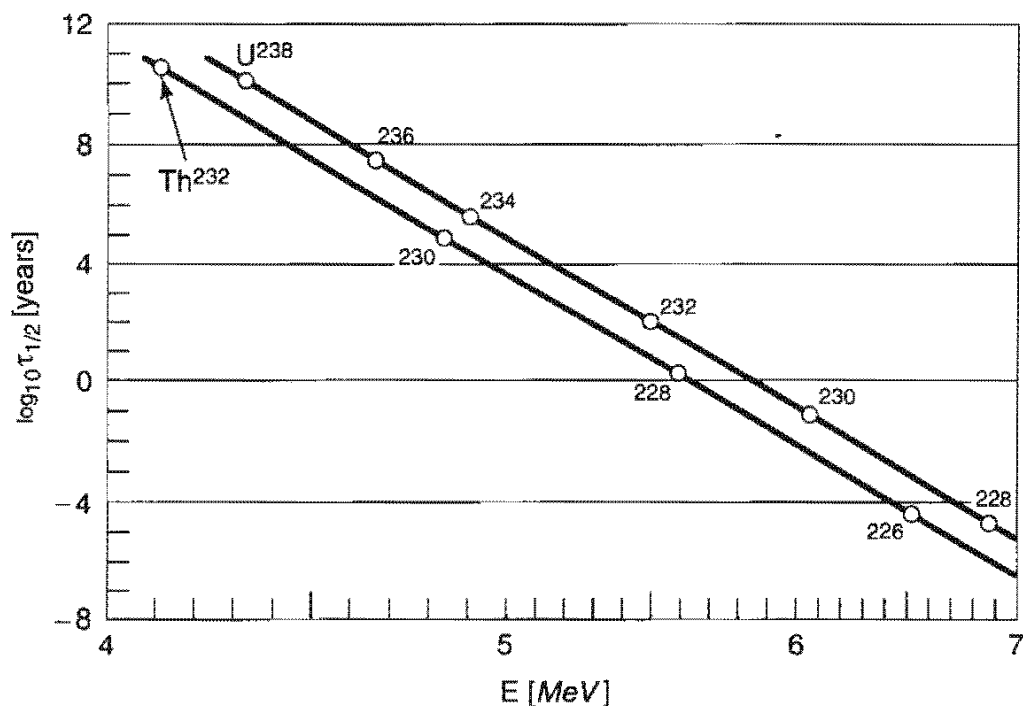

Figure 8.6: Graph of the logarithm of the lifetime versus $1/\sqrt{E}$, for several alpha emitters. From David Park, *Introduction to the Quantum Theory*, 3rd ed. (New York: McGraw-Hill, 1992). (See acknowledgment in Preface.)

$$E = m_p c^2 - m_d c^2 - m_\alpha c^2, \quad [8.30]$$

where m_p is the mass of the parent nucleus, m_d is the mass of the daughter nucleus, and m_α is the mass of the alpha particle (which is to say, the He^4 nucleus). To figure out what the daughter nucleus is, note that the alpha particle carries off two protons and two neutrons, so Z decreases by 2 and A by 4. Look up the relevant nuclear masses. To estimate v , use $E = (1/2)m_\alpha v^2$; this ignores the (negative) potential energy inside the nucleus, and surely *underestimates* v , but it's about the best we can do at this stage. Incidentally, the experimental lifetimes are 6×10^9 years and $0.5 \mu\text{s}$, respectively.

8.3 THE CONNECTION FORMULAS

In the discussion so far I have assumed that the “walls” of the potential well (or the barrier) are *vertical*, so that the “exterior” solution is simple and the boundary conditions trivial. As it turns out, our main results (Equations 8.16 and 8.22) are reasonably accurate even when the edges are not so abrupt (indeed, in Gamow’s theory they were applied to just such a case). Nevertheless, it is of some interest to study more closely what happens to the wave function at a turning point ($E = V$), where the “classical” region joins the “nonclassical” region and the WKB approximation

itself breaks down. In this section I'll treat the bound-state problem (Figure 8.1); you get to do the scattering problem for yourself (Problem 8.10).⁵

For simplicity, let's shift the axes over so that the right-hand turning point occurs at $x = 0$ (Figure 8.7). In the WKB approximation, we have

$$\psi(x) \cong \begin{cases} \frac{1}{\sqrt{p(x)}} \left[B e^{\frac{i}{\hbar} \int_x^0 p(x') dx'} + C e^{-\frac{i}{\hbar} \int_x^0 p(x') dx'} \right], & \text{if } x < 0, \\ \frac{1}{\sqrt{|p(x)|}} D e^{-\frac{1}{\hbar} \int_0^x |p(x')| dx'}, & \text{if } x > 0. \end{cases} \quad [8.31]$$

[Assuming that $V(x)$ remains greater than E for all $x > 0$, we can exclude the positive exponent in this region, because it blows up as $x \rightarrow \infty$.] Our task is to join the two solutions at the boundary. But there is a serious difficulty here: In the WKB approximation, ψ goes to *infinity* at the turning point, where $p(x) \rightarrow 0$. The *true* wave function, of course, has no such wild behavior—as anticipated, the WKB method simply fails in the vicinity of a turning point. And yet, it is precisely the boundary conditions at the turning points that determine the allowed energies. What we need to do, then, is *splice* the two WKB solutions together, using a “patching” wave function that straddles the turning point.

Since we only need the patching wave function (ψ_p) in the neighborhood of the origin, we'll *approximate the potential by a straight line*:

$$V(x) \cong E + V'(0)x, \quad [8.32]$$

and solve the Schrödinger for this linearized V :

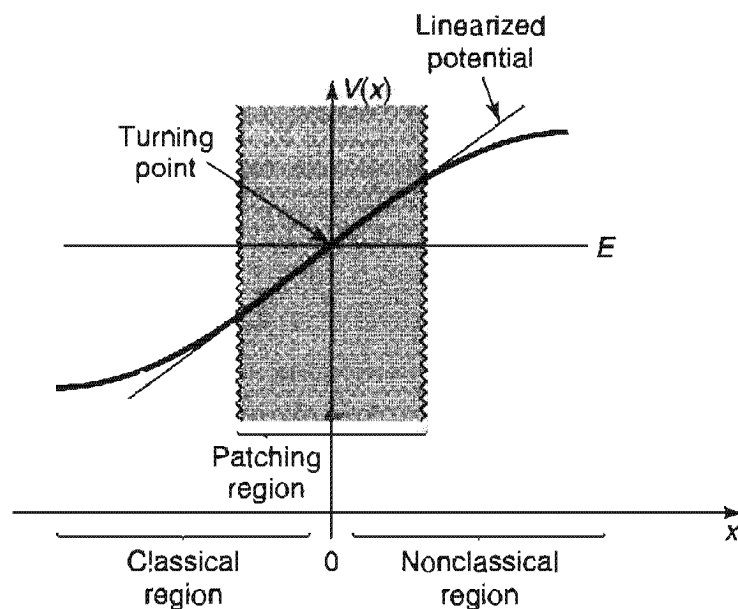

Figure 8.7: Enlarged view of the right-hand turning point.

⁵Warning: The following argument is quite technical, and you may wish to skip it on a first reading.

$$-\frac{\hbar^2}{2m} \frac{d^2 \psi_p}{dx^2} + (E + V'(0)x) \psi_p = E \psi_p,$$

or

$$\frac{d^2 \psi_p}{dx^2} = \alpha^3 x \psi_p, \tag{8.33}$$

where

$$\alpha \equiv \left[\frac{2m}{\hbar^2} V'(0) \right]^{1/3}. \tag{8.34}$$

The α 's can be absorbed into the independent variable by defining

$$z \equiv \alpha x, \tag{8.35}$$

so that

$$\frac{d^2 \psi_p}{dz^2} = z \psi_p. \tag{8.36}$$

This is **Airy's equation**, and the solutions are called **Airy functions**.⁶ Since the Airy equation is a second-order differential equation, there are two linearly independent

Table 8.1: Some properties of the Airy functions.

| | | | |
|--|--|--|--|
| <i>Differential Equation:</i> | $\frac{d^2 y}{dz^2} = zy.$ | | |
| <i>Solutions:</i> | Linear combinations of Airy Functions, $Ai(z)$ and $Bi(z)$. | | |
| <i>Integral Representation:</i> | $Ai(z) = \frac{1}{\pi} \int_0^\infty \cos\left(\frac{s^3}{3} + sz\right) ds$ $Bi(z) = \frac{1}{\pi} \int_0^\infty \left[e^{-\frac{s^3}{3} + sz} + \sin\left(\frac{s^3}{3} + sz\right) \right] ds$ | | |
| <i>Asymptotic Forms:</i> | <table style="width: 100%; border: none;"> <tr> <td style="width: 50%; text-align: center;"> $\left. \begin{aligned} Ai(z) &\sim \frac{1}{2\sqrt{\pi} z^{1/4}} e^{-\frac{2}{3}z^{3/2}} \\ Bi(z) &\sim \frac{1}{\sqrt{\pi} z^{1/4}} e^{\frac{2}{3}z^{3/2}} \end{aligned} \right\} z \gg 0$ </td> <td style="width: 50%; text-align: center;"> $\left. \begin{aligned} Ai(z) &\sim \frac{1}{\sqrt{\pi}(-z)^{1/4}} \sin\left[\frac{2}{3}(-z)^{3/2} + \frac{\pi}{4}\right] \\ Bi(z) &\sim \frac{1}{\sqrt{\pi}(-z)^{1/4}} \cos\left[\frac{2}{3}(-z)^{3/2} + \frac{\pi}{4}\right] \end{aligned} \right\} z \ll 0$ </td> </tr> </table> | $\left. \begin{aligned} Ai(z) &\sim \frac{1}{2\sqrt{\pi} z^{1/4}} e^{-\frac{2}{3}z^{3/2}} \\ Bi(z) &\sim \frac{1}{\sqrt{\pi} z^{1/4}} e^{\frac{2}{3}z^{3/2}} \end{aligned} \right\} z \gg 0$ | $\left. \begin{aligned} Ai(z) &\sim \frac{1}{\sqrt{\pi}(-z)^{1/4}} \sin\left[\frac{2}{3}(-z)^{3/2} + \frac{\pi}{4}\right] \\ Bi(z) &\sim \frac{1}{\sqrt{\pi}(-z)^{1/4}} \cos\left[\frac{2}{3}(-z)^{3/2} + \frac{\pi}{4}\right] \end{aligned} \right\} z \ll 0$ |
| $\left. \begin{aligned} Ai(z) &\sim \frac{1}{2\sqrt{\pi} z^{1/4}} e^{-\frac{2}{3}z^{3/2}} \\ Bi(z) &\sim \frac{1}{\sqrt{\pi} z^{1/4}} e^{\frac{2}{3}z^{3/2}} \end{aligned} \right\} z \gg 0$ | $\left. \begin{aligned} Ai(z) &\sim \frac{1}{\sqrt{\pi}(-z)^{1/4}} \sin\left[\frac{2}{3}(-z)^{3/2} + \frac{\pi}{4}\right] \\ Bi(z) &\sim \frac{1}{\sqrt{\pi}(-z)^{1/4}} \cos\left[\frac{2}{3}(-z)^{3/2} + \frac{\pi}{4}\right] \end{aligned} \right\} z \ll 0$ | | |

⁶Classically, a linear potential means a constant force, and hence a constant acceleration—the simplest nontrivial motion possible, and the *starting* point for elementary mechanics. It is ironic that the same potential in *quantum* mechanics gives rise to unfamiliar transcendental functions, and plays only a peripheral role in the theory.

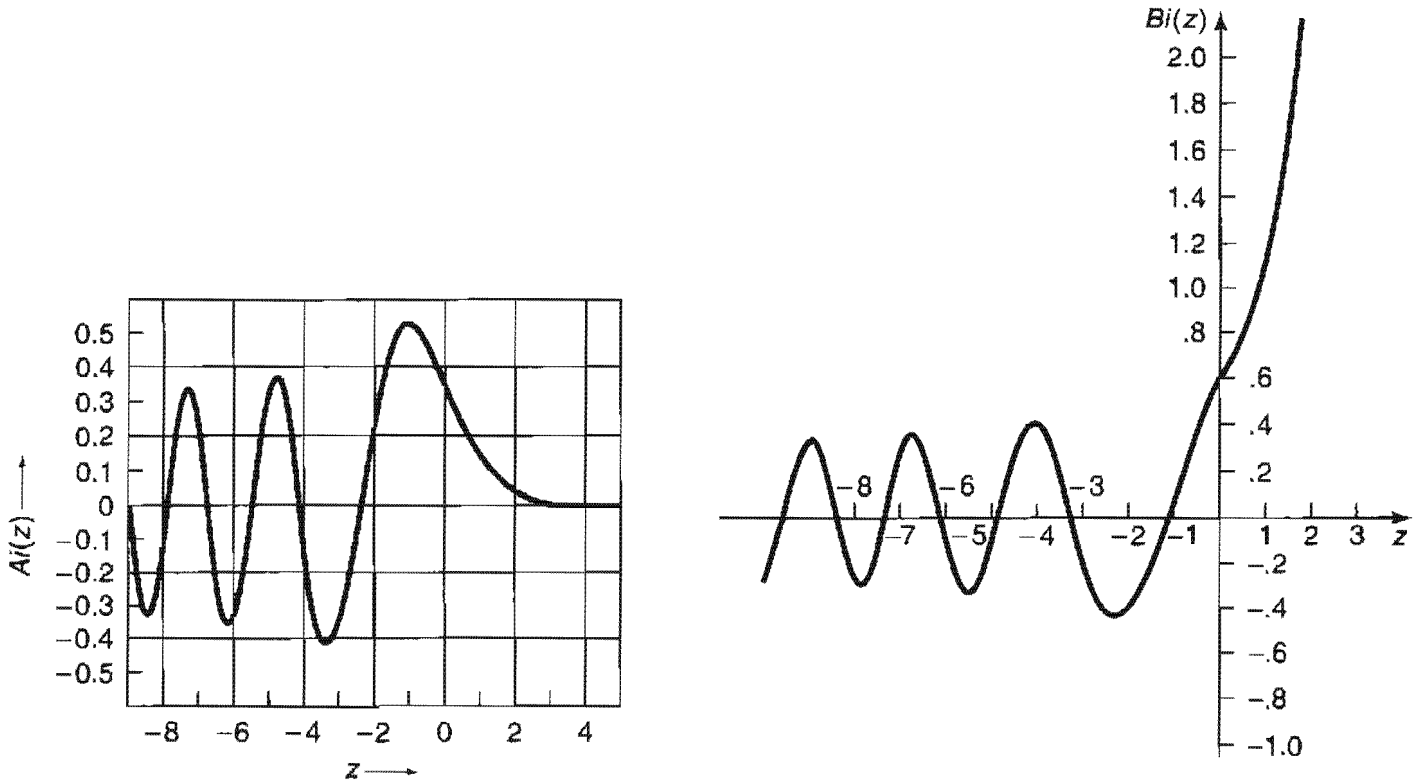

Figure 8.8: Graph of the Airy functions.

Airy functions, $Ai(z)$ and $Bi(z)$; the general solution is a linear combination of these. Ai and Bi are related to Bessel functions of order $1/3$; some of their properties are listed in Table 8.1 and they are plotted in Figure 8.8. Evidently the patching wave function is

$$\psi_p(x) = a Ai(\alpha x) + b Bi(\alpha x), \tag{8.37}$$

for appropriate constants a and b .

Now ψ_p is the (approximate) wave function in the neighborhood of the origin; our job is to match it to the WKB solutions in the overlap regions on either side (see Figure 8.9). These overlap zones are close enough to the turning point that the linearized potential is reasonably accurate (so that ψ_p is a good approximation to the true wave function), and yet far enough away from the turning point that the WKB approximation is reliable.⁷ In the overlap regions Equation 8.32 holds, and therefore (in the notation of Equation 8.34)

$$p(x) \cong \sqrt{2m(E - E - V'(0)x)} = \hbar\alpha^{3/2}\sqrt{-x}. \tag{8.38}$$

In particular, in overlap region 2,

⁷This is a delicate double constraint, and it is possible to concoct potentials so pathological that no such overlap region exists. However, in practical applications this seldom occurs. See Problem 8.8.

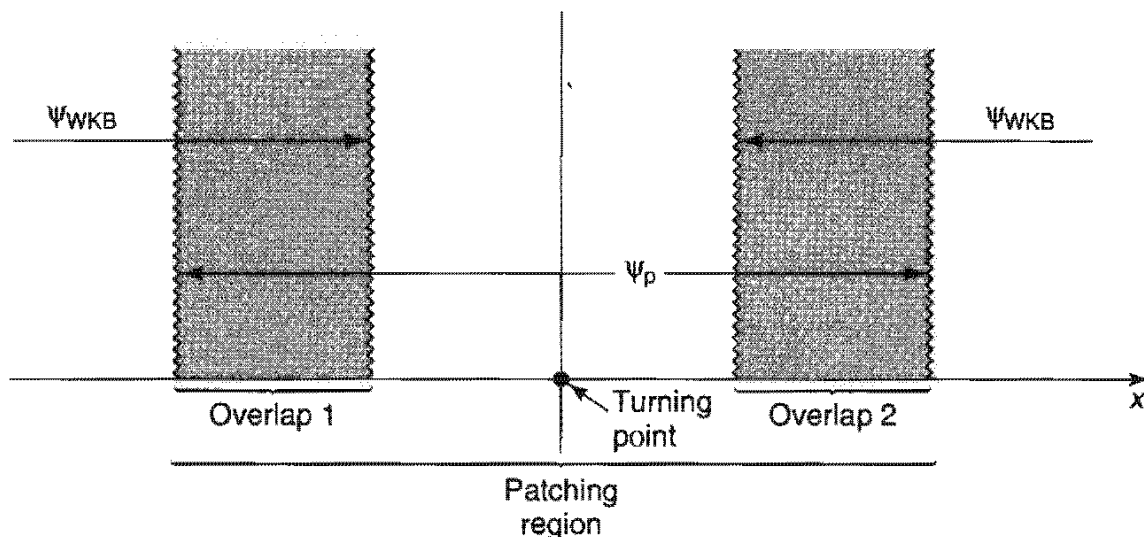

Figure 8.9: Patching region and the two overlap zones.

$$\int_0^x |p(x')| dx' \cong \hbar \alpha^{3/2} \int_0^x \sqrt{x'} dx' = \frac{2}{3} \hbar (\alpha x)^{3/2},$$

and therefore the WKB wave function (Equation 8.31) can be written as

$$\psi(x) \cong \frac{D}{\sqrt{\hbar \alpha^{3/4} x^{1/4}}} e^{-\frac{2}{3}(\alpha x)^{3/2}}. \quad [8.39]$$

Meanwhile, using the large- z asymptotic forms⁸ of the Airy functions (from Table 8.1), the patching wave function (Equation 8.37) in overlap region 2 becomes

$$\psi_p(x) \cong \frac{a}{2\sqrt{\pi}(\alpha x)^{1/4}} e^{-\frac{2}{3}(\alpha x)^{3/2}} + \frac{b}{\sqrt{\pi}(\alpha x)^{1/4}} e^{\frac{2}{3}(\alpha x)^{3/2}}. \quad [8.40]$$

Comparing the two solutions, we see that

$$a = \sqrt{\frac{4\pi}{\alpha \hbar}} D, \quad \text{and} \quad b = 0. \quad [8.41]$$

Now we go back and repeat the procedure for overlap region 1. Once again, $p(x)$ is given by Equation 8.38, but this time x is *negative*, so

$$\int_x^0 p(x') dx' \cong \frac{2}{3} \hbar (-\alpha x)^{3/2} \quad [8.42]$$

and the WKB wave function (Equation 8.31) is

⁸At first glance it seems absurd to use a *large- z* approximation in this region, which after all is supposed to be reasonably close to the turning point at $z = 0$ (so that the linear approximation to the potential is valid). But notice that the argument here is αx , and if you study the matter carefully (see Problem 8.8) you will find that there *is* (typically) a region in which αx is large, but at the same time it is reasonable to approximate $V(x)$ by a straight line.

$$\psi(x) \cong \frac{1}{\sqrt{\hbar\alpha^{3/4}(-x)^{1/4}}} \left[B e^{i\frac{2}{3}(-\alpha x)^{3/2}} + C e^{-i\frac{2}{3}(-\alpha x)^{3/2}} \right]. \quad [8.43]$$

Meanwhile, using the asymptotic form of the Airy function for large *negative* z (Table 8.1), the patching function (Equation 8.37, with $b = 0$) reads

$$\begin{aligned} \psi_p(x) &\cong \frac{a}{\sqrt{\pi(-\alpha x)^{1/4}}} \sin \left[\frac{2}{3}(-\alpha x)^{3/2} + \frac{\pi}{4} \right] \\ &= \frac{a}{\sqrt{\pi(-\alpha x)^{1/4}}} \frac{1}{2i} \left[e^{i\pi/4} e^{i\frac{2}{3}(-\alpha x)^{3/2}} - e^{-i\pi/4} e^{-i\frac{2}{3}(-\alpha x)^{3/2}} \right]. \end{aligned} \quad [8.44]$$

Comparing the WKB and patching wave functions in overlap region 1, we find

$$\frac{a}{2i\sqrt{\pi}} e^{i\pi/4} = \frac{B}{\sqrt{\hbar\alpha}} \quad \text{and} \quad \frac{-a}{2i\sqrt{\pi}} e^{-i\pi/4} = \frac{C}{\sqrt{\hbar\alpha}},$$

or, putting in Equation 8.41 for a ,

$$B = -i e^{i\pi/4} D, \quad \text{and} \quad C = i e^{-i\pi/4} D. \quad [8.45]$$

These are the so-called **connection formulas**, joining the WKB solutions at either side of the turning point. We're done with the patching wave function now—its only purpose was to bridge the gap. Expressing everything in terms of the one normalization constant D , and shifting the turning point back from the origin to an arbitrary point x_2 , the WKB wave function (Equation 8.31) becomes

$$\psi(x) \cong \begin{cases} \frac{2D}{\sqrt{p(x)}} \sin \left[\frac{1}{\hbar} \int_x^{x_2} p(x') dx' + \frac{\pi}{4} \right], & \text{if } x < x_2; \\ \frac{D}{\sqrt{|p(x)|}} e^{-\frac{1}{\hbar} \int_x^{x_2} |p(x')| dx'}, & \text{if } x > x_2. \end{cases} \quad [8.46]$$

Example: Potential well with one vertical wall. Imagine a potential well that has one vertical side (at $x = 0$) and one sloping side (Figure 8.10). In this case $\psi(0) = 0$, so Equation 8.46 says

$$\frac{1}{\hbar} \int_0^{x_2} p(x) dx + \frac{\pi}{4} = n\pi, \quad (n = 1, 2, 3, \dots),$$

or

$$\int_0^{x_2} p(x) dx = \left(n - \frac{1}{4} \right) \pi \hbar. \quad [8.47]$$

For instance, consider the “half-harmonic oscillator”,

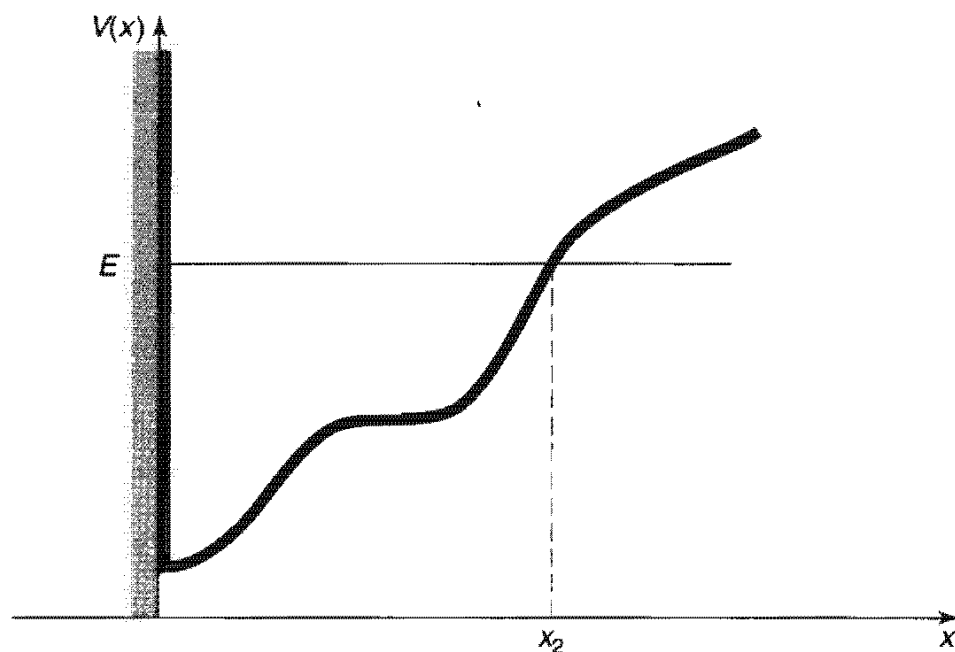

Figure 8.10: Potential well with one vertical wall.

$$V(x) = \begin{cases} \frac{1}{2}m\omega^2x^2, & \text{if } x > 0, \\ 0, & \text{otherwise.} \end{cases} \quad [8.48]$$

In this case

$$p(x) = \sqrt{2m[E - (1/2)m\omega^2x^2]} = m\omega\sqrt{x_2^2 - x^2},$$

where

$$x_2 = \frac{1}{\omega}\sqrt{\frac{2E}{m}}$$

is the turning point. So

$$\int_0^{x_2} p(x) dx = m\omega \int_0^{x_2} \sqrt{x_2^2 - x^2} dx = \frac{\pi}{4}m\omega x_2^2 = \frac{\pi E}{2\omega},$$

and the quantization condition Equation 8.47 yields

$$E_n = \left(2n - \frac{1}{2}\right)\hbar\omega = \left(\frac{3}{2}, \frac{7}{2}, \frac{11}{2}, \dots\right)\hbar\omega. \quad [8.49]$$

In this particular case the WKB approximation actually delivers the *exact* allowed energies (which are precisely the *odd* energies of the *full* harmonic oscillator—see Problem 2.38).

Example: Potential well with no vertical walls. Equation 8.46 connects the WKB wave functions at a turning point where the potential slopes *upward*

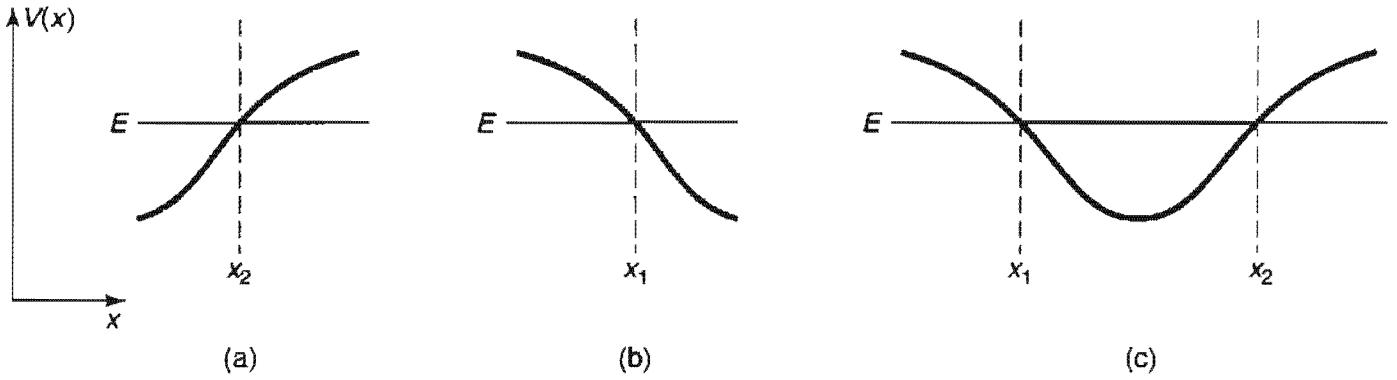

Figure 8.11: Upward-sloping and downward-sloping turning points.

(Figure 8.11a); the same reasoning, applied to a *downward*-sloping turning point (Figure 8.11b), yields (Problem 8.9)

$$\psi(x) \cong \begin{cases} \frac{D'}{\sqrt{|p(x)|}} e^{-\frac{1}{\hbar} \int_x^{x_1} |p(x')| dx'}, & \text{if } x < x_1; \\ \frac{2D'}{\sqrt{p(x)}} \sin \left[\frac{1}{\hbar} \int_{x_1}^x p(x') dx' + \frac{\pi}{4} \right], & \text{if } x > x_1. \end{cases} \quad [8.50]$$

In particular, if we're talking about a potential *well* (Figure 8.11c), the wave function in the “interior” region ($x_1 < x < x_2$) can be written *either* as

$$\psi(x) \cong \frac{2D}{\sqrt{p(x)}} \sin \theta_2(x), \quad \text{where } \theta_2(x) \equiv \frac{1}{\hbar} \int_x^{x_2} p(x') dx' + \frac{\pi}{4}$$

(Equation 8.46), *or* as

$$\psi(x) \cong \frac{-2D'}{\sqrt{p(x)}} \sin \theta_1(x), \quad \text{where } \theta_1(x) \equiv -\frac{1}{\hbar} \int_{x_1}^x p(x') dx' - \frac{\pi}{4}$$

(Equation 8.50). Evidently the arguments of the sine functions must be equal, modulo π :⁹ $\theta_2 = \theta_1 + n\pi$, from which it follows that

$$\int_{x_1}^{x_2} p(x) dx = \left(n - \frac{1}{2} \right) \pi \hbar, \quad \text{with } n = 1, 2, 3, \dots \quad [8.51]$$

This quantization condition determines the allowed energies for the “typical” case of a potential well with two sloping sides. Notice that it differs from the formulas

⁹Not 2π —an overall minus sign can be absorbed into the normalization factors D and D' .

for two vertical walls (Equation 8.16) or one vertical wall (Equation 8.47) only in the number that is subtracted from n (0, 1/4, or 1/2). Since the WKB approximation works best in the semiclassical (large n) regime, the distinction is more in appearance than in substance. In any event, the result is extraordinarily powerful, for it enables us to calculate (approximate) allowed energies *without ever solving the Schrödinger equation*, by simply evaluating one integral. The wave function itself has dropped out of sight.

****Problem 8.5** Consider the quantum mechanical analog to the classical problem of a ball (mass m) bouncing elastically on the floor.

- (a) What is the potential energy, as a function of height x above the floor? (For negative x , the potential is *infinite*—the ball can't get there at all.)
- (b) Solve the Schrödinger equation for this potential, expressing your answer in terms of the appropriate Airy function [note that $Bi(z)$ blows up for large z , and hence does not yield a normalizable wave function]. Don't bother to normalize $\psi(x)$.
- (c) Using $g = 9.80 \text{ m/s}^2$ and $m = 0.100 \text{ kg}$, find the first four allowed energies, in Joules, correct to three significant digits. *Hint:* see Milton Abramowitz and Irene A. Stegun, *Handbook of Mathematical Functions* (New York: Dover 1970), page 478; the notation is defined on page 450.
- (d) What is the ground state energy, in eV, of an *electron* in this gravitational field? How high off the ground is this electron, on the average? *Hint:* Use the virial theorem to determine $\langle x \rangle$.

***Problem 8.6** Analyze the bouncing ball (Problem 8.5) using the WKB approximation.

- (a) Find the allowed energies E_n in terms of m , g , and \hbar .
- (b) Now put in the particular values given in Problem 8.5(c), and compare the WKB approximation to the first four energies with the "exact" results.
- (c) About how large would the quantum number n have to be to give the ball an average height of, say, 1 meter above the ground?

***Problem 8.7** Use the WKB approximation to find the allowed energies of the harmonic oscillator.

Problem 8.8 Consider a particle of mass m in the n th stationary state of the harmonic oscillator (angular frequency ω).

- (a) Find the turning point x_2 .

- (b) How far (d) could you go *above* the turning point before the error in the linearized potential (Equation 8.32, but with the turning point at x_2) reaches 1%? That is, if

$$\frac{V(x_2 + d) - V_{\text{lin}}(x_2 + d)}{V(x_2)} = 0.01,$$

what is d ?

- (c) The asymptotic form of $Ai(z)$ is accurate to 1% as long as $z \geq 5$. For the d in part (b), determine the smallest n such that $\alpha d \geq 5$. (For any n larger than this, there exists an overlap region in which the linearized potential is good to 1% and the large- z form of the Airy function is good to 1%.)

****Problem 8.9** Derive the connection formulas at a downward-sloping turning point, and confirm Equation 8.50.

*****Problem 8.10** Use appropriate connection formulas to analyse the problem of scattering from a barrier with sloping walls (Figure 8.12). Begin by writing the WKB wave function in the form

$$\psi(x) \cong \begin{cases} \frac{1}{\sqrt{p(x)}} \left[A e^{\frac{i}{\hbar} \int_x^{x_1} p(x') dx'} + B e^{-\frac{i}{\hbar} \int_x^{x_1} p(x') dx'} \right], & (x < x_1); \\ \frac{1}{\sqrt{|p(x)|}} \left[C e^{\frac{i}{\hbar} \int_{x_1}^x |p(x')| dx'} + D e^{-\frac{i}{\hbar} \int_{x_1}^x |p(x')| dx'} \right], & (x_1 < x < x_2); \\ \frac{1}{\sqrt{p(x)}} \left[F e^{\frac{i}{\hbar} \int_{x_2}^x p(x') dx'} \right], & (x > x_2). \end{cases} \quad [8.52]$$

Do *not* assume $C = 0$. Calculate the tunneling probability, $T = |F|^2/|A|^2$, and show that your result reduces to Equation 8.22 in the case of a broad, high barrier.

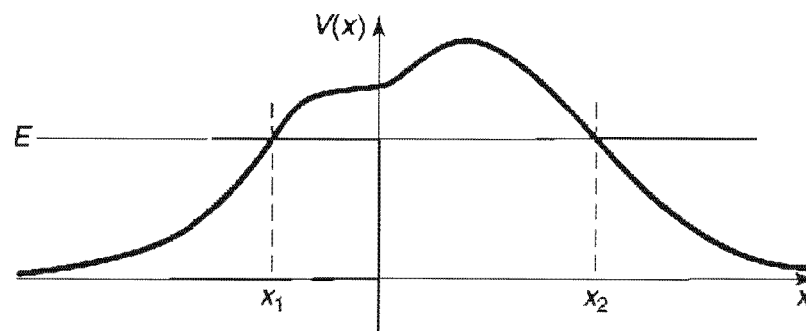

Figure 8.12: Barrier with sloping walls.

FURTHER PROBLEMS FOR CHAPTER 8

****Problem 8.11** Use the WKB approximation to find the allowed energies of the general power-law potential:

$$V(x) = \alpha|x|^\nu,$$

where ν is a positive number. Check your result for the case $\nu = 2$. *Answer:*

$$E_n = \alpha \left[(n - 1/2)\hbar \sqrt{\frac{\pi}{2m\alpha} \frac{\Gamma(\frac{1}{\nu} + \frac{3}{2})}{\Gamma(\frac{1}{\nu} + 1)}} \right]^{\frac{2\nu}{\nu+2}}. \quad [8.53]$$

****Problem 8.12** Use the WKB approximation to find the bound-state energy for the potential in Problem 2.48. Compare the exact answer. *Answer:*

$$-[(9/8) - (1/\sqrt{2})]\hbar^2 a^2/m.$$

Problem 8.13 For spherically symmetrical potentials, we can apply the WKB approximation to the radial equation, (Equation 4.37). In the case $l = 0$, it is reasonable¹⁰ to use Equation 8.47 in the form

$$\int_0^{r_0} p(r) dr = (n - 1/4)\pi\hbar, \quad [8.54]$$

where r_0 is the turning point (in effect, we treat $r = 0$ as an infinite wall). Apply this formula to estimate the allowed energies of a particle in the logarithmic potential

$$V(r) = V_0 \ln(r/a)$$

(for constants V_0 and a). Treat only the case $l = 0$. Show that the spacing between the levels is independent of mass. *Partial answer:*

$$E_{n+1} - E_n = V_0 \ln \left(\frac{n + 3/4}{n - 1/4} \right).$$

****Problem 8.14** Use the WKB approximation in the form

$$\int_{r_1}^{r_2} p(r) dr = (n - 1/2)\pi\hbar \quad [8.55]$$

¹⁰Application of the WKB approximation to the radial equation raises some delicate and subtle problems, which I will not go into here. The classic paper on the subject is R. Langer, *Phys. Rev.* **51**, 669 (1937).

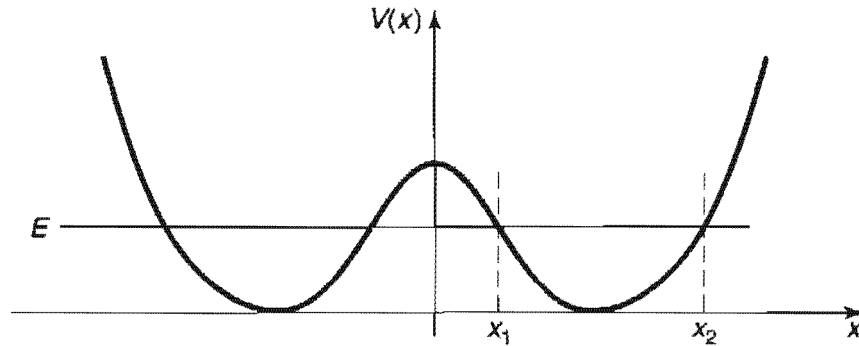

Figure 8.13: Symmetric double well; Problem 8.15.

to estimate the bound state-energies for hydrogen. Don't forget the centrifugal term in the effective potential Equation 4.38. The following integral may help:

$$\int_a^b \frac{1}{x} \sqrt{(x-a)(b-x)} = \frac{\pi}{2} (\sqrt{b} - \sqrt{a})^2. \quad [8.56]$$

Note that you recover the Bohr levels when $n \gg l$ and $n \gg 1/2$. Answer:

$$E_{nl} \cong \frac{-13.6 \text{ eV}}{[n - (1/2) + \sqrt{l(l+1)}]^2}. \quad [8.57]$$

*****Problem 8.15** Consider the case of a symmetrical double-well, such as the one pictured in Figure 8.13. We are interested in bound states with $E < V(0)$.

- (a) Write down the WKB wave functions in regions (i) $x > x_2$, (ii) $x_1 < x < x_2$, and (iii) $0 < x < x_1$. Impose the appropriate connection formulas at x_1 and x_2 (this has already been done, in Equation 8.46, for x_2 ; you will have to work out x_1 for yourself), to show that

$$\psi(x) \cong \begin{cases} \frac{D}{\sqrt{|p(x)|}} e^{-\frac{1}{\hbar} \int_{x_2}^x |p(x')| dx'}, & \text{(i)} \\ \frac{2D}{\sqrt{p(x)}} \sin \left[\frac{1}{\hbar} \int_x^{x_2} p(x') dx' + \frac{\pi}{4} \right], & \text{(ii)} \\ \frac{D}{\sqrt{|p(x)|}} \left[2 \cos \theta e^{\frac{1}{\hbar} \int_x^{x_1} |p(x')| dx'} + \sin \theta e^{-\frac{1}{\hbar} \int_x^{x_1} |p(x')| dx'} \right], & \text{(iii)} \end{cases}$$

where

$$\theta \equiv \frac{1}{\hbar} \int_{x_1}^{x_2} p(x) dx. \quad [8.58]$$

- (b) Because $V(x)$ is symmetric, we need only consider even (+) and odd (−) wave functions. In the former case $\psi'(0) = 0$, and in the latter case $\psi(0) = 0$. Show that this leads to the following quantization condition:

$$\tan \theta = \pm 2e^{\phi}, \quad [8.59]$$

where

$$\phi \equiv \frac{1}{\hbar} \int_{-x_1}^{x_1} |p(x')| dx'. \quad [8.60]$$

Equation 8.59 determines the (approximate) allowed energies (note that E comes into x_1 and x_2 , so θ and ϕ are both functions of E).

- (c) We are particularly interested in a high and/or broad central barrier, in which case ϕ is large and e^{ϕ} is *huge*. Equation 8.59 then tells us that θ must be very close to a half-integer multiple of π . With this in mind, write $\theta = (n+1/2)\pi + \epsilon$, where $|\epsilon| \ll 1$, and show that the quantization condition becomes

$$\theta \cong \left(n + \frac{1}{2}\right) \pi \mp \frac{1}{2} e^{-\phi}. \quad [8.61]$$

- (d) Suppose each well is a parabola¹¹:

$$V(x) = \begin{cases} \frac{1}{2} m \omega^2 (x+a)^2, & \text{if } x < 0, \\ \frac{1}{2} m \omega^2 (x-a)^2, & \text{if } x > 0. \end{cases} \quad [8.62]$$

Sketch this potential, find θ (Equation 8.58), and show that

$$E_n^{\pm} \cong \left(n + \frac{1}{2}\right) \hbar \omega \mp \frac{\hbar \omega}{2\pi} e^{-\phi}. \quad [8.63]$$

Note: If the central barrier were *impenetrable* ($\phi \rightarrow \infty$), we would simply have two detached harmonic oscillators, and the energies $E_n = (n+1/2)\hbar\omega$ would be doubly degenerate, since the particle could be in the left well or in the right one. When the barrier becomes *finite*, putting the two wells into “communication”, the degeneracy is lifted. The even states (ψ_n^+) have slightly *lower* energy, and the odd ones (ψ_n^-) have slightly higher energy.

¹¹ Even if $V(x)$ is not strictly parabolic in each well, this calculation of θ , and hence the result (Equation 8.63), will be *approximately* correct, in the sense discussed in Section 2.3, with $\omega \equiv \sqrt{V''(x_0)/m}$, where x_0 is the position of the minimum.

- (e) Suppose the particle starts out in the *right* well—or, more precisely, in a state of the form

$$\Psi(x, 0) = \frac{1}{\sqrt{2}}(\psi_n^+ + \psi_n^-),$$

which, assuming the phases are picked in the “natural” way, will be concentrated in the right well. Show that it oscillates back and forth between the wells, with a period

$$\tau = \frac{2\pi^2}{\omega} e^\phi. \quad [8.64]$$

- (f) Calculate ϕ , for the specific potential in part (d), and show that for $V(0) \gg E$, $\phi \sim m\omega a^2/\hbar$.
-

CHAPTER 9

TIME-DEPENDENT PERTURBATION THEORY

Up to this point, practically everything we have done belongs to the subject that might properly be called **quantum statics**, in which the potential energy function is *independent of time*: $V(\mathbf{r}, t) = V(\mathbf{r})$. In that case the (time-dependent) Schrödinger equation,

$$H\Psi = i\hbar \frac{\partial \Psi}{\partial t},$$

can be solved by separation of variables:

$$\Psi(\mathbf{r}, t) = \psi(\mathbf{r})e^{-iEt/\hbar},$$

where $\psi(\mathbf{r})$ satisfies the time-*independent* Schrödinger equation,

$$H\psi = E\psi.$$

Because the time dependence of Ψ is carried by the exponential factor ($e^{-iEt/\hbar}$), which cancels out when we construct the physically relevant quantity $|\Psi|^2$, all probabilities and expectation values are constant in time. By forming *linear combinations* of these stationary states we obtain wave functions with more interesting time dependence, but even then the possible values of the energy, and their respective probabilities, are constant.

If we want to allow for **transitions** between one energy level and another, we must introduce a *time-dependent* potential (**quantum dynamics**). There are precious few exactly solvable problems in quantum dynamics. However, if the time-dependent portion of the Hamiltonian is small compared to the time-independent part, it can be treated as a perturbation. My purpose in this chapter is to develop time-dependent

perturbation theory, and study its most important application: the emission or absorption of radiation by an atom—a process known in the old Bohr theory as a **quantum jump**.

9.1 TWO-LEVEL SYSTEMS

To begin with, let us suppose that there are just *two* states of the (unperturbed) system, ψ_a and ψ_b . They are eigenstates of the unperturbed Hamiltonian H_0 :

$$H_0\psi_a = E_a\psi_a \quad \text{and} \quad H_0\psi_b = E_b\psi_b, \quad [9.1]$$

and they are orthonormal:

$$\langle \psi_a | \psi_b \rangle = \delta_{ab}. \quad [9.2]$$

Any state can be expressed as a linear combination of them; in particular,

$$\Psi(0) = c_a\psi_a + c_b\psi_b. \quad [9.3]$$

The states ψ_a and ψ_b might be position-space wave functions, or spinors, or something more exotic—it doesn't matter. It is the *time* dependence that concerns us here, so when I write $\Psi(t)$, I simply mean the state of the system at time t . In the absence of any perturbation, each component evolves with its characteristic exponential factor:

$$\Psi(t) = c_a\psi_a e^{-iE_a t/\hbar} + c_b\psi_b e^{-iE_b t/\hbar}. \quad [9.4]$$

We say that $|c_a|^2$ is the “probability that the particle is in state ψ_a ”—by which we *really* mean the probability that a measurement of the energy would yield the value E_a . Normalization of Ψ requires, of course, that

$$|c_a|^2 + |c_b|^2 = 1. \quad [9.5]$$

9.1.1 The Perturbed System

Now suppose we turn on a time-dependent perturbation $H'(t)$. Since ψ_a and ψ_b constitute a complete set, the wave function $\Psi(t)$ can still be expressed as a linear combination of them. The only difference is that c_a and c_b are now *functions of t* :

$$\Psi(t) = c_a(t)\psi_a e^{-iE_a t/\hbar} + c_b(t)\psi_b e^{-iE_b t/\hbar}. \quad [9.6]$$

[I *could* absorb the exponential factors into $c_a(t)$ and $c_b(t)$, and some people prefer to do it this way, but I think it is nicer to keep visible that part of the time dependence that would be present even *without* the perturbation.] The whole problem is to determine c_a and c_b as functions of time. If, for example, the particle started out in the state ψ_a ,

so that $c_a(0) = 1$ and $c_b(0) = 0$, and at some later time t_1 we find that $c_a(t_1) = 0$, $c_b(t_1) = 1$, we shall report that the system underwent a **transition** from ψ_a to ψ_b .

We solve for $c_a(t)$ and $c_b(t)$ by demanding that $\Psi(t)$ satisfy the time-dependent Schrödinger equation,

$$H\Psi = i\hbar \frac{\partial \Psi}{\partial t}, \quad \text{where } H = H_0 + H'(t). \quad [9.7]$$

From Equations 9.6 and 9.7, we find

$$\begin{aligned} & c_a[H_0\psi_a]e^{-iE_a t/\hbar} + c_b[H_0\psi_b]e^{-iE_b t/\hbar} + c_a[H'\psi_a]e^{-iE_a t/\hbar} \\ & + c_b[H'\psi_b]e^{-iE_b t/\hbar} = i\hbar \left[\dot{c}_a\psi_a e^{-iE_a t/\hbar} + \dot{c}_b\psi_b e^{-iE_b t/\hbar} \right. \\ & \left. + c_a\psi_a \left(-\frac{iE_a}{\hbar} \right) e^{-iE_a t/\hbar} + c_b\psi_b \left(-\frac{iE_b}{\hbar} \right) e^{-iE_b t/\hbar} \right]. \end{aligned}$$

In view of Equation 9.1, the first two terms on the left cancel the last two terms on the right, and hence

$$c_a[H'\psi_a]e^{-iE_a t/\hbar} + c_b[H'\psi_b]e^{-iE_b t/\hbar} = i\hbar \left[\dot{c}_a\psi_a e^{-iE_a t/\hbar} + \dot{c}_b\psi_b e^{-iE_b t/\hbar} \right]. \quad [9.8]$$

To isolate \dot{c}_a , we use the standard trick: Take the inner product with ψ_a , and exploit the orthogonality of ψ_a and ψ_b (Equation 9.2):

$$c_a \langle \psi_a | H' | \psi_a \rangle e^{-iE_a t/\hbar} + c_b \langle \psi_a | H' | \psi_b \rangle e^{-iE_b t/\hbar} = i\hbar \dot{c}_a e^{-iE_a t/\hbar}.$$

For short, we define

$$H'_{ij} \equiv \langle \psi_i | H' | \psi_j \rangle; \quad [9.9]$$

note that the Hermiticity of H' entails $H'_{ji} = (H'_{ij})^*$. Multiplying through by $-(i/\hbar)e^{iE_a t/\hbar}$, we conclude that

$$\dot{c}_a = -\frac{i}{\hbar} \left[c_a H'_{aa} + c_b H'_{ab} e^{-i(E_b - E_a)t/\hbar} \right]. \quad [9.10]$$

Similarly, the inner product with ψ_b picks out \dot{c}_b :

$$c_a \langle \psi_b | H' | \psi_a \rangle e^{-iE_a t/\hbar} + c_b \langle \psi_b | H' | \psi_b \rangle e^{-iE_b t/\hbar} = i\hbar \dot{c}_b e^{-iE_b t/\hbar},$$

and hence

$$\dot{c}_b = -\frac{i}{\hbar} \left[c_b H'_{bb} + c_a H'_{ba} e^{i(E_b - E_a)t/\hbar} \right]. \quad [9.11]$$

Equations 9.10 and 9.11 determine $c_a(t)$ and $c_b(t)$; taken together, they are completely equivalent to the (time-dependent) Schrödinger equation, for a two-level system. Typically, the diagonal matrix elements of H' vanish (see Problem 9.4 for the more general case in which the diagonal terms are *not* zero):

$$H'_{aa} = H'_{bb} = 0. \quad [9.12]$$

In that case the equations simplify:

$$\begin{aligned} \dot{c}_a &= -\frac{i}{\hbar} H'_{ab} e^{-i\omega_0 t} c_b, \\ \dot{c}_b &= -\frac{i}{\hbar} H'_{ba} e^{i\omega_0 t} c_a, \end{aligned} \quad [9.13]$$

where

$$\omega_0 \equiv \frac{E_b - E_a}{\hbar}. \quad [9.14]$$

(We'll assume that $E_b \geq E_a$, so $\omega_0 \geq 0$.)

***Problem 9.1** A hydrogen atom is placed in a (time-dependent) electric field $\mathbf{E} = E(t)\hat{k}$. Calculate all four matrix elements H'_{ij} of the perturbation $H' = -eEz$ between the ground state ($n = 1$) and the (quadruply degenerate) first excited states ($n = 2$). Also show that $H'_{ii} = 0$ for all five states. *Note:* There is only one integral to be done here, if you exploit oddness with respect to z . As a result, only one of the $n = 2$ states is “accessible” from the ground state by a perturbation of this form, and therefore the system functions as a two-level configuration— assuming transitions to higher excited states can be ignored.

***Problem 9.2** Solve Equation 9.13 for the case of a *time-independent* perturbation, assuming that $c_a(0) = 1$ and $c_b(0) = 0$. Check that $|c_a(t)|^2 + |c_b(t)|^2 = 1$. *Note:* Ostensibly, this system oscillates between “pure ψ_a ” and “some ψ_b ”. Doesn't this contradict my general assertion that no transitions occur for time-independent perturbations? No, but the reason is rather subtle: In this case ψ_a and ψ_b are not, and never were, eigenstates of the Hamiltonian—a measurement of the energy *never* yields E_a or E_b . In time-dependent perturbation theory we typically contemplate turning *on* the perturbation for a while, and then turning it *off* again, in order to examine the system. At the beginning, and at the end, ψ_a and ψ_b are eigenstates of the exact Hamiltonian, and only in this context does it make sense to say that the system underwent a transition from one to the other. For the present problem, then, assume that the perturbation was turned on at time $t = 0$, and off again at time t —this doesn't affect the *calculations*, but it allows for a more sensible interpretation of the result.

Problem 9.3 Suppose the perturbation takes the form of a delta function (in time):

$$H' = U\delta(t - t_0);$$

assume that $U_{aa} = U_{bb} = 0$, and let $U_{ab} \equiv \alpha$. If $c_a(-\infty) = 1$ and $c_b(-\infty) = 0$, find $c_a(t)$ and $c_b(t)$, and check that $|c_a(t)|^2 + |c_b(t)|^2 = 1$. What is the probability ($P_{a \rightarrow b}$) that a transition occurs? *Hint:* Refer to Problem 2.24. *Answer:* $P_{a \rightarrow b} = (|\alpha|^2/\hbar^2)/(1 + |\alpha|^2/4\hbar^2)^2$.

9.1.2 Time-Dependent Perturbation Theory

So far, everything is *exact*: We have made no assumption about the *size* of the perturbation. But if H' is “small”, we can solve Equations 9.13 by a process of successive approximations, as follows. Suppose the particle starts out in the lower state:

$$c_a(0) = 1, \quad c_b(0) = 0. \quad [9.15]$$

If there were *no perturbation at all*, they would stay this way forever:

Zeroth Order:

$$c_a^{(0)}(t) = 1, \quad c_b^{(0)}(t) = 0. \quad [9.16]$$

To calculate the first-order approximation, we insert these values on the right side of Equation 9.13:

First Order:

$$\begin{aligned} \frac{dc_a}{dt} = 0 &\Rightarrow c_a^{(1)}(t) = 1; \\ \frac{dc_b}{dt} = -\frac{i}{\hbar} H'_{ba} e^{i\omega_0 t} &\Rightarrow c_b^{(1)} = -\frac{i}{\hbar} \int_0^t H'_{ba}(t') e^{i\omega_0 t'} dt'. \end{aligned} \quad [9.17]$$

Now we insert *these* expressions on the right to obtain the *second-order* approximation:

Second Order:

$$\begin{aligned} \frac{dc_a}{dt} = -\frac{i}{\hbar} H'_{ab} e^{-i\omega_0 t} \left(-\frac{i}{\hbar} \right) \int_0^t H'_{ba}(t') e^{i\omega_0 t'} dt' &\Rightarrow \\ c_a^{(2)}(t) = 1 - \frac{1}{\hbar^2} \int_0^t H'_{ab}(t') e^{-i\omega_0 t'} \left[\int_0^{t'} H'_{ba}(t'') e^{i\omega_0 t''} dt'' \right] dt', & \quad [9.18] \end{aligned}$$

while c_b is unchanged, $c_b^{(2)}(t) = c_b^{(1)}(t)$. [Notice that in my notation $c_a^{(2)}(t)$ *includes* the zeroth order term; the second-order *correction* would be the integral term alone.]

In principle, we could continue this ritual indefinitely, always inserting the n^{th} -order approximation into the right side of Equation 9.13 and solving for the $(n+1)^{\text{th}}$ order. Notice that c_a is modified in every *even* order, and c_b in every *odd* order. Incidentally, the error in the first-order approximation is evident in the fact that $|c_a^{(1)}(t)|^2 + |c_b^{(1)}(t)|^2 \neq 1$ (the *exact* coefficients must, of course, obey Equation 9.5). However, $|c_a^{(1)}(t)|^2 + |c_b^{(1)}(t)|^2$ is equal to 1 to first order in H' , which is all we can expect from a first-order approximation. And the same goes for the higher orders.

****Problem 9.4** Suppose you *don't* assume that $H'_{aa} = H'_{bb} = 0$.

(a) Find $c_a(t)$ and $c_b(t)$ in first-order perturbation theory, for the case $c_a(0) = 1$, $c_b(0) = 0$. Show that $|c_a^{(1)}(t)|^2 + |c_b^{(1)}(t)|^2 = 1$, to first order in H' .

(b) There is a nicer way to handle this problem. Let

$$d_a \equiv e^{\frac{i}{\hbar} \int_0^t H'_{aa}(t') dt'} c_a, \quad d_b \equiv e^{\frac{i}{\hbar} \int_0^t H'_{bb}(t') dt'} c_b. \quad [9.19]$$

Show that

$$\dot{d}_a = -\frac{i}{\hbar} e^{i\phi} H'_{ab} e^{-i\omega_0 t} d_b; \quad \dot{d}_b = -\frac{i}{\hbar} e^{-i\phi} H'_{ba} e^{i\omega_0 t} d_a, \quad [9.20]$$

where

$$\phi(t) \equiv \frac{1}{\hbar} \int_0^t [H'_{aa}(t') - H'_{bb}(t')] dt'. \quad [9.21]$$

So the equations for d_a and d_b are identical in structure to Equation 9.13 (with an extra factor $e^{i\phi}$ tacked onto H').

(c) Use the method in part (b) to obtain $c_a(t)$ and $c_b(t)$ in first-order perturbation theory, and compare your answer to (a). Comment on any discrepancies.

***Problem 9.5** Solve Equation 9.13 to second order in perturbation theory, for the general case $c_a(0) = a$, $c_b(0) = b$.

****Problem 9.6** Calculate $c_a(t)$ and $c_b(t)$, to second order, for the perturbation in Problem 9.2. Compare your answer with the exact result.

9.1.3 Sinusoidal Perturbations

Suppose the perturbation has sinusoidal time dependence:

$$H'(\mathbf{r}, t) = V(\mathbf{r}) \cos(\omega t), \quad [9.22]$$

so that

$$H'_{ab} = V_{ab} \cos(\omega t), \quad [9.23]$$

where

$$V_{ab} \equiv \langle \psi_a | V | \psi_b \rangle. \quad [9.24]$$

(As before, I'll assume that the *diagonal* matrix elements vanish, since this is almost always the case in practice.) To first order (from now on we'll work *exclusively* in first order) we have (Equation 9.17)

$$c_b(t) \cong -\frac{i}{\hbar} V_{ba} \int_0^t \cos(\omega t') e^{i\omega_0 t'} dt' = -\frac{iV_{ba}}{2\hbar} \int_0^t \left[e^{i(\omega_0 + \omega)t'} + e^{i(\omega_0 - \omega)t'} \right] dt'$$

$$= -\frac{V_{ba}}{2\hbar} \left[\frac{e^{i(\omega_0+\omega)t} - 1}{\omega_0 + \omega} + \frac{e^{i(\omega_0-\omega)t} - 1}{\omega_0 - \omega} \right]. \quad [9.25]$$

This is the *answer*, but it's a little cumbersome to work with. Things simplify substantially if we restrict our attention to driving frequencies (ω) that are very close to the transition frequency (ω_0), so that the second term in the square brackets dominates: specifically, we assume

$$\omega_0 + \omega \gg |\omega_0 - \omega|. \quad [9.26]$$

This is not much of a limitation, since perturbations at *other* frequencies have a negligible probability of causing a transition *anyway*.¹ Dropping the first term, we have

$$\begin{aligned} c_b(t) &\cong -\frac{V_{ba}}{2\hbar} \frac{e^{i(\omega_0-\omega)t/2}}{\omega_0 - \omega} [e^{i(\omega_0-\omega)t/2} - e^{-i(\omega_0-\omega)t/2}] \\ &= -i \frac{V_{ba}}{\hbar} \frac{\sin[(\omega_0 - \omega)t/2]}{\omega_0 - \omega} e^{i(\omega_0-\omega)t/2}. \end{aligned} \quad [9.27]$$

The **transition probability**—the probability that a particle which started out in the state ψ_a will be found, at time t , in the state ψ_b —is

$$P_{a \rightarrow b}(t) = |c_b(t)|^2 \cong \frac{|V_{ab}|^2 \sin^2[(\omega_0 - \omega)t/2]}{\hbar^2 (\omega_0 - \omega)^2}. \quad [9.28]$$

The most remarkable feature of this result is that, as a function of time, the transition probability *oscillates* sinusoidally (Figure 9.1). After rising to a maximum of $|V_{ab}|^2/\hbar^2(\omega_0 - \omega)^2$ —necessarily much less than 1, else the assumption that the perturbation is “small” would be invalid—it drops back down to zero! At times $t_n = 2n\pi/|\omega_0 - \omega|$, where $n = 1, 2, 3, \dots$, the particle is *certain* to be back in the lower state. If you want to maximize your chances of provoking a transition, you should *not* keep the perturbation on for a long period: You do better to *turn it off* after a time $\pi/|\omega_0 - \omega|$, and hope to “catch” the system in the upper state. In Problem 9.7 it is shown that this “flopping” is not an artifact of perturbation theory—it also occurs in the *exact* solution, though the flopping *frequency* is modified somewhat.

As I noted earlier, the probability of a transition is greatest when the driving frequency is close to the “natural” frequency ω_0 . This is illustrated in Figure 9.2, where $P_{a \rightarrow b}$ is plotted as a function of ω . The peak has a height of $(|V_{ab}|t/2\hbar)^2$ and a width $4\pi/t$; evidently it gets higher and narrower as time goes on. (Ostensibly, the maximum increases without limit. However, the perturbation assumption breaks down before it gets close to 1, so we can believe the result only for relatively small t . In Problem 9.7 you will see that the *exact* result never exceeds 1.)

¹In the following sections we will be applying this theory to the case of *light*, for which $\omega \sim 10^{14}$ Hz, so the denominator in *both* terms is huge, except (for the second one) in the neighborhood of ω_0 .

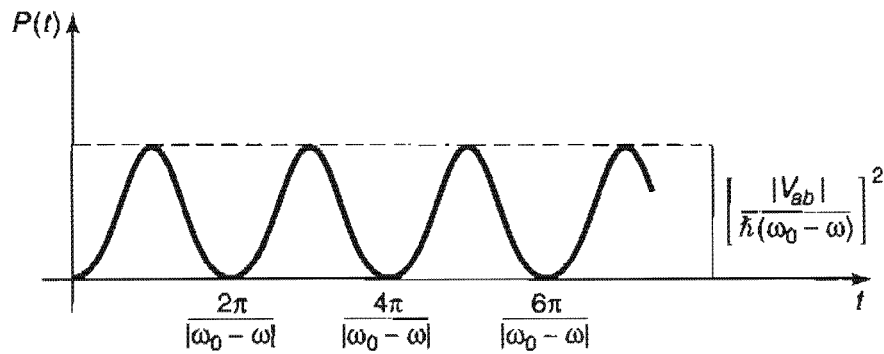

Figure 9.1: Transition probability as a function of time, for a sinusoidal perturbation (Equation 9.28).

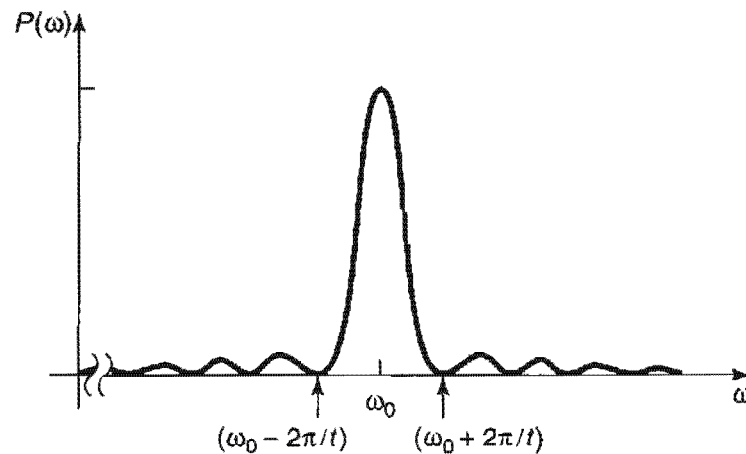

Figure 9.2: Transition probability as a function of driving frequency (Equation 9.28).

****Problem 9.7** The first term in Equation 9.25 comes from the $e^{i\omega t}/2$ part of $\cos(\omega t)$, and the second from $e^{-i\omega t}/2$. Thus dropping the first term is *formally* equivalent to writing $H' = (V/2)e^{-i\omega t}$, which is to say,

$$H'_{ba} = \frac{V_{ba}}{2} e^{-i\omega t}, \quad H'_{ab} = \frac{V_{ab}}{2} e^{i\omega t}. \quad [9.29]$$

[The latter is required to make the Hamiltonian matrix Hermitian—or, if you prefer, to pick out the dominant term in the formula analogous to Equation 9.25 for $c_a(t)$.] If you make this so-called **rotating wave approximation** at the *beginning* of the calculation, Equation 9.13 can be solved *exactly*, with no need for perturbation theory and no assumption about the strength of the field.

- (a) Solve Equation 9.13 in the rotating wave approximation (Equation 9.29) for the usual initial conditions: $c_a(0) = 1$, $c_b(0) = 0$. Express your results [$c_a(t)$ and

$c_b(t)$] in terms of the **Rabi flopping frequency**,

$$\omega_r \equiv \frac{1}{2} \sqrt{(\omega - \omega_0)^2 + (|V_{ab}|/\hbar)^2}. \quad [9.30]$$

- (b) Determine the transition probability, $P_{a \rightarrow b}(t)$, and show that it never exceeds 1. Confirm that $|c_a(t)|^2 + |c_b(t)|^2 = 1$.
- (c) Check that $P_{a \rightarrow b}(t)$ reduces to the perturbation theory result (Equation 9.28) when the perturbation is “small”, and state precisely what small *means* in this context, as a constraint on V .
- (d) At what time does the system first return to its initial state?

9.2 EMISSION AND ABSORPTION OF RADIATION

9.2.1 Electromagnetic Waves

An electromagnetic wave (I’ll refer to it as “light,” though it could be infrared, ultraviolet, microwave, X-ray, etc.; these differ only in their frequencies) consists of transverse (and mutually perpendicular) oscillating electric and magnetic fields (Figure 9.3). An atom, in the presence of a passing light wave, responds primarily to the electric component. If the wavelength is long (compared to the size of the atom), we can ignore the *spatial* variation in the field²; the atom, then, is exposed to a sinusoidally oscillating electric field

$$\mathbf{E} = E_0 \cos(\omega t) \hat{k} \quad [9.31]$$

(for the moment I’ll assume that the light is monochromatic and polarized along the z -direction). The perturbing Hamiltonian is³

$$H' = -q E_0 z \cos(\omega t), \quad [9.32]$$

where q is the charge of the electron.⁴ Evidently⁵

$$H'_{ba} = -\wp E_0 \cos(\omega t), \quad \text{where} \quad \wp \equiv q \langle \psi_b | z | \psi_a \rangle. \quad [9.33]$$

²For visible light $\lambda \sim 5000 \text{ \AA}$, while the diameter of an atom is around 1 \AA , so this approximation is reasonable; but it would *not* be for X-rays. Problem 9.20 explores the effect of spatial variation in the field.

³The energy of a charge q in a static field \mathbf{E} is $-q \int \mathbf{E} \cdot d\mathbf{r}$. You may well object to the use of an *electrostatic* formula for a manifestly time-dependent field. I am implicitly assuming that the period of oscillation is long compared to the time it takes the charge to move around (within an atom).

⁴As usual, we assume that the nucleus is heavy and stationary; it is the wave function of the *electron* we are concerned with.

⁵The letter \wp is supposed to remind you of **electric dipole moment** (for which, in electrodynamics, the letter p is customarily used—in this context it is rendered as a squiggly \wp to avoid confusion with momentum). In fact, \wp is the off-diagonal matrix element of the z -component of the dipole moment operator $q\mathbf{r}$.

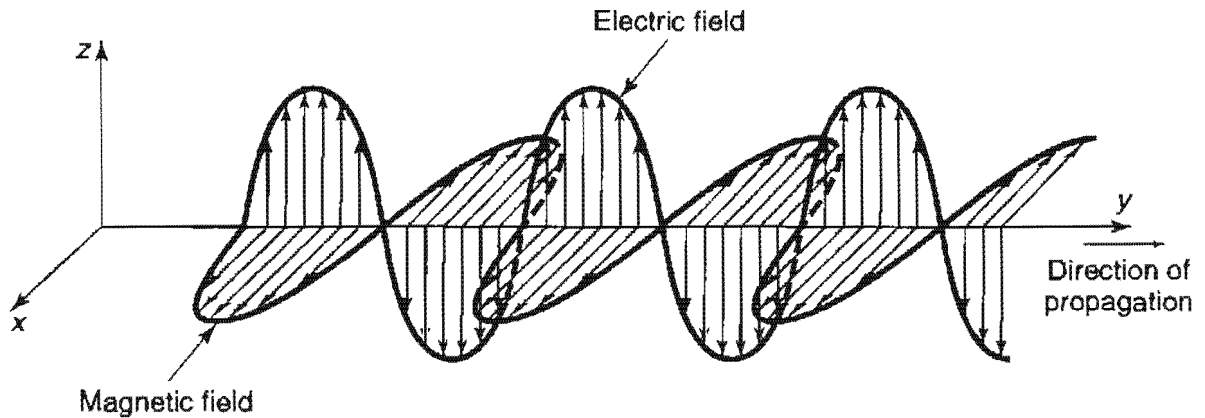

Figure 9.3: An electromagnetic wave.

Typically, ψ is an even or odd function of z ; in either case $z|\psi|^2$ is odd, and integrates to zero (see Problem 9.1 for some examples). This licenses our usual assumption that the *diagonal* matrix elements of H' vanish. Thus the interaction of light with matter is governed by precisely the kind of oscillatory perturbation we studied in Section 9.1.3, with

$$V_{ba} = -\wp E_0. \tag{9.34}$$

9.2.2 Absorption, Stimulated Emission, and Spontaneous Emission

If an atom starts out in the “lower” state ψ_a , and you shine a polarized monochromatic beam of light on it, the probability of a transition to the “upper” state ψ_b is given by Equation 9.28, which (in view of Equation 9.34) takes the form

$$P_{a \rightarrow b}(t) = \left(\frac{|\wp| E_0}{\hbar} \right)^2 \frac{\sin^2[(\omega_0 - \omega)t/2]}{(\omega_0 - \omega)^2}. \tag{9.35}$$

In this process, the atom absorbs energy $E_b - E_a = \hbar\omega_0$ from the electromagnetic field. We say that it has “absorbed a photon” (Figure 9.4a). [As I mentioned earlier, the word “*photon*” really belongs to **quantum electrodynamics** (the quantum theory of the electromagnetic field), whereas we are treating the field itself *classically*. But this terminology is convenient, as long as you don’t read more into it than is really there.]

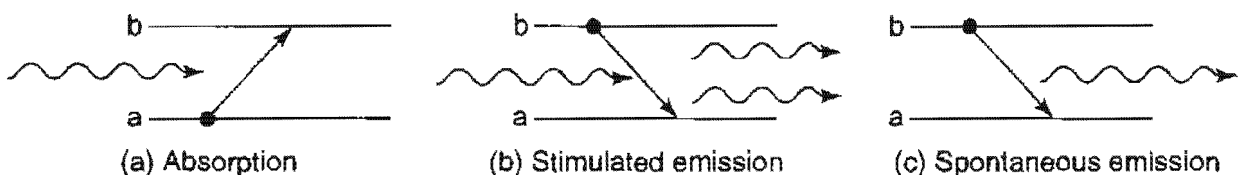

Figure 9.4: Three ways in which light interacts with atoms: (a) absorption, (b) stimulated emission, (c) spontaneous emission.

I could, of course, go back and run the whole derivation for a system that starts off in the *upper* state [$c_a(0) = 0$, $c_b(0) = 1$]. Do it for yourself, if you like; it comes out *exactly the same*—except that this time we’re calculating $P_{b \rightarrow a} = |c_a(t)|^2$, the probability of a transition *down* to the *lower* level:

$$P_{b \rightarrow a}(t) = \left(\frac{|\mathcal{D}|E_0}{\hbar} \right)^2 \frac{\sin^2[(\omega_0 - \omega)t/2]}{(\omega_0 - \omega)^2}. \quad [9.36]$$

(It *has* to come out this way—all we’re doing is switching $a \leftrightarrow b$, which substitutes $-\omega_0$ for ω_0 . When we get to Equation 9.25 we keep the *first* term, with $-\omega_0 + \omega$ in the denominator, and the rest is the same as before.) But when you stop to think of it, this is an absolutely *astonishing* result: If the particle is in the *upper* state, and you shine light on it, it can make a transition to the *lower* state, and in fact the probability of such a transition is exactly the same as for a transition *upward* from the *lower* state. This process, which was first discovered by Einstein, is called **stimulated emission**.

In the case of stimulated emission the electromagnetic field *gains* energy $\hbar\omega_0$ from the atom; we say that one photon went in and *two* photons came out—the original one that caused the transition plus another one from the transition itself (Figure 9.4b). This raises the possibility of *amplification*, for if I could obtain a bottle of atoms, all in the upper state, and trigger it with a single incident photon, a chain reaction would occur, with the first photon producing 2, and these 2 producing 4, and so on. We’d have an enormous number of photons coming out, all with the same frequency and at virtually the same instant. This is, of course, the principle behind the **laser** (*light amplification by stimulated emission of radiation*). Note that it is essential (for laser action) to get a majority of the atoms into the upper state (a so-called **population inversion**), because *absorption* (which *costs* one photon) competes with stimulated emission (which *produces* one); if you started with an even mixture of the two states, you’d get no amplification at all.

There is a *third* mechanism (in addition to absorption and stimulated emission) by which radiation interacts with matter; it is called **spontaneous emission**. Here an atom in the excited state makes a transition downward, with the release of a photon but *without* any applied electromagnetic field to initiate the process (Figure 9.4c). This is the mechanism that accounts for the normal decay of an atomic excited state. At first sight it is far from clear why spontaneous emission should occur at *all*. If the atom is in a stationary state (albeit an excited one), and there is no external perturbation, it should just *sit there forever*. And so it *would*, if it were *really* free of all external perturbations. However, in quantum electrodynamics the fields are nonzero *even in the ground state*—just as the harmonic oscillator (for example) has nonzero energy (to wit, $\hbar\omega/2$) in its ground state. You can turn out all the lights, and cool the room down to absolute zero, but there is still some electromagnetic radiation present, and it is this “zero-point” radiation that serves to catalyze spontaneous emission. When you come right down to it, there is really *no such thing* as *truly* spontaneous emission; it’s *all* stimulated emission. The only distinction to be made is whether the field that

does the stimulating is one that *you* put there, or one that *God* put there. In this sense it is exactly the reverse of the classical radiative process, in which it's *all* spontaneous and there is no such thing as *stimulated* emission.

Quantum electrodynamics is beyond the scope of this book,⁶ but there is a lovely argument due to Einstein⁷ which interrelates the three processes (absorption, stimulated emission, and spontaneous emission). Einstein did not identify the *mechanism* responsible for spontaneous emission (perturbation by the ground-state electromagnetic field), but his results nevertheless enable us to calculate the spontaneous emission rate, and from that the natural lifetime of an excited atomic state. Before we turn to that, however, we need to consider the response of an atom to non-monochromatic, unpolarized, incoherent electromagnetic waves coming in from all directions—such as it would encounter, for instance, if it were immersed in thermal radiation.

9.2.3 Incoherent Perturbations

The energy density in an electromagnetic wave is⁸

$$u = \frac{\epsilon_0}{2} E_0^2, \quad [9.37]$$

where E_0 is (as before) the amplitude of the electric field. So the transition probability (Equation 9.36) is (not surprisingly) proportional to the energy density of the fields:

$$P_{b \rightarrow a}(t) = \frac{2u}{\epsilon_0 \hbar^2} |\delta\mathcal{D}|^2 \frac{\sin^2[(\omega_0 - \omega)t/2]}{(\omega_0 - \omega)^2}. \quad [9.38]$$

But this is for a **monochromatic** perturbation, consisting of a single frequency ω . In many applications the system is exposed to electromagnetic waves at a whole *range* of frequencies; in that case $u \rightarrow \rho(\omega)d\omega$, where $\rho(\omega)d\omega$ is the energy density in the

⁶For an especially nice treatment, see Rodney Loudon, *The Quantum Theory of Light*, 2nd ed. (Oxford: Clarendon Press, 1983).

⁷Einstein's paper was published in 1917, well before the Schrödinger equation. Quantum electrodynamics comes into the argument via the Planck blackbody formula (Equation 5.112), which dates from 1900.

⁸See, for example, D. Halliday and R. Resnick, *Fundamentals of Physics*, 3rd ed., extended (New York: John Wiley & Sons, 1988), Section 38-5. In general, the energy per unit volume in electromagnetic fields is

$$u = (\epsilon_0/2)E^2 + (1/2\mu_0)B^2.$$

For electromagnetic waves, the electric and magnetic contributions are equal, so

$$u = \epsilon_0 E^2 = \epsilon_0 E_0^2 \cos^2(\omega t),$$

and the average over a full cycle is $(\epsilon_0/2)E_0^2$, since the average of \cos^2 (or \sin^2) is 1/2.

frequency range $d\omega$, and the net transition probability takes the form of an integral:⁹

$$P_{b \rightarrow a}(t) = \frac{2}{\epsilon_0 \hbar^2} |\wp|^2 \int_0^\infty \rho(\omega) \left\{ \frac{\sin^2[(\omega_0 - \omega)t/2]}{(\omega_0 - \omega)^2} \right\} d\omega. \quad [9.39]$$

Ordinarily, the term in curly brackets is sharply peaked about ω_0 (Figure 9.2), whereas $\rho(\omega)$ is relatively broad; in that case we may as well replace $\rho(\omega)$ by $\rho(\omega_0)$ and take it outside the integral:

$$P_{b \rightarrow a}(t) \cong \frac{2|\wp|^2}{\epsilon_0 \hbar^2} \rho(\omega_0) \int_0^\infty \frac{\sin^2[(\omega_0 - \omega)t/2]}{(\omega_0 - \omega)^2} d\omega. \quad [9.40]$$

Changing variables to $x \equiv (\omega_0 - \omega)t/2$, extending the limits of integration to $x = \pm\infty$ (since the integrand is essentially zero out there anyway), and looking up the definite integral

$$\int_{-\infty}^\infty \frac{\sin^2 x}{x^2} dx = \pi, \quad [9.41]$$

we find

$$P_{b \rightarrow a}(t) \cong \frac{\pi |\wp|^2}{\epsilon_0 \hbar^2} \rho(\omega_0) t. \quad [9.42]$$

This time the transition probability is proportional to t . The bizarre “flopping” phenomenon characteristic of a monochromatic perturbation gets “washed out” when we hit the system with an incoherent spread of frequencies. In particular, the **transition rate** ($R \equiv dP/dt$) is now a *constant*:

$$R_{b \rightarrow a} = \frac{\pi}{\epsilon_0 \hbar^2} |\wp|^2 \rho(\omega_0). \quad [9.43]$$

So far, we have assumed that the perturbing wave is coming in along the x -direction (Figure 9.3) and polarized in the z -direction. But we shall be interested in the case of an atom bathed in radiation coming from *all* directions, and with all possible polarizations; the energy in the fields [$\rho(\omega)$] is shared equally among these different modes. What we need, in place of $|\wp|^2$, is the *average* of $|\hat{n} \cdot \wp|^2$, where

$$\wp \equiv q \langle \psi_b | \mathbf{r} | \psi_a \rangle \quad [9.44]$$

(generalizing Equation 9.33), and the average is over both polarizations (\hat{n}) and over all incident directions. This averaging can be carried out as follows.

⁹Equation 9.39 assumes that the perturbations at different frequencies are *independent*, so that the total transition probability is a sum of the individual probabilities. If the different components are **coherent** (phase correlated), then we should add *amplitudes* [$c_b(t)$], not *probabilities* ($|c_b(t)|^2$), and there will be cross-terms. For the applications we will consider the perturbations are always incoherent.

Polarization: For propagation in the z -direction, the two possible polarizations are \hat{i} and \hat{j} , so the polarization average (subscript p) is

$$(\hat{n} \cdot \mathbf{p})_p^2 = \frac{1}{2}[(\hat{i} \cdot \mathbf{p})^2 + (\hat{j} \cdot \mathbf{p})^2] = \frac{1}{2}(\rho_x^2 + \rho_y^2) = \frac{1}{2}\rho^2 \sin^2 \theta, \quad [9.45]$$

where θ is the angle between \mathbf{p} and the direction of propagation.

Propagation direction: Now let's set the polar axis along \mathbf{p} and integrate over all propagation directions to get the polarization–propagation average (subscript pp):

$$(\hat{n} \cdot \mathbf{p})_{pp}^2 = \frac{1}{4\pi} \int \left[\frac{1}{2}\rho^2 \sin^2 \theta \right] \sin \theta \, d\theta \, d\phi = \frac{\rho^2}{4} \int_0^\pi \sin^3 \theta \, d\theta = \frac{\rho^2}{3}. \quad [9.46]$$

So the transition rate for stimulated emission from state b to state a , under the influence of incoherent, unpolarized light incident from all directions, is

$$R_{b \rightarrow a} = \frac{\pi}{3\epsilon_0 \hbar^2} |\mathbf{p}|^2 \rho(\omega_0), \quad [9.47]$$

where \mathbf{p} is the matrix element of the electric dipole moment between the two states (Equation 9.44) and $\rho(\omega_0)$ is the energy density in the fields, per unit frequency, evaluated at $\omega_0 = (E_b - E_a)/\hbar$.¹⁰

9.3 SPONTANEOUS EMISSION

9.3.1 Einstein's A and B coefficients

Picture a container of atoms, N_a of them in the lower state (ψ_a), and N_b of them in the upper state (ψ_b). Let A be the spontaneous emission rate,¹¹ so that the number of particles leaving the upper state by this process, per unit time, is $N_b A$.¹² The transition rate for stimulated emission, as we have seen (Equation 9.47), is proportional to the energy density of the electromagnetic field—call it $B_{ba}\rho(\omega_0)$. The number of particles leaving the upper state by this mechanism, per unit time, is $N_b B_{ba}\rho(\omega_0)$. The absorption rate is likewise proportional to $\rho(\omega_0)$ —call it $B_{ab}\rho(\omega_0)$; the number of particles per unit time *joining* the upper level is therefore $N_a B_{ab}\rho(\omega_0)$. All told, then,

$$\frac{dN_b}{dt} = -N_b A - N_b B_{ba}\rho(\omega_0) + N_a B_{ab}\rho(\omega_0). \quad [9.48]$$

¹⁰This is a special case of Fermi's **Golden Rule** for time-dependent perturbation theory.

¹¹Normally I'd use R for a transition rate, but out of deference to *der Alte* everyone follows Einstein's notation in this context.

¹²Assume that N_a and N_b are very large, so we can treat them as continuous functions of time, and ignore statistical fluctuations.

Suppose that these atoms are in thermal equilibrium with the ambient field, so that the number of particles in each level is *constant*. In that case $dN_b/dt = 0$, and it follows that

$$\rho(\omega_0) = \frac{A}{(N_a/N_b)B_{ab} - B_{ba}}. \quad [9.49]$$

On the other hand, we know from elementary statistical mechanics¹³ that the number of particles with energy E , in thermal equilibrium at temperature T , is proportional to the **Boltzmann factor**, $\exp(-E/k_B T)$, so

$$\frac{N_a}{N_b} = \frac{e^{-E_a/k_B T}}{e^{-E_b/k_B T}} = e^{\hbar\omega_0/k_B T}, \quad [9.50]$$

and hence

$$\rho(\omega_0) = \frac{A}{e^{\hbar\omega_0/k_B T} B_{ab} - B_{ba}}. \quad [9.51]$$

But Planck's blackbody formula Equation 5.112 tells us the energy density of thermal radiation:

$$\rho(\omega) = \frac{\hbar}{\pi^2 c^3} \frac{\omega^3}{e^{\hbar\omega/k_B T} - 1}; \quad [9.52]$$

comparing the two expressions, we conclude that

$$B_{ab} = B_{ba} \quad [9.53]$$

and

$$A = \frac{\omega^3 \hbar}{\pi^2 c^3} B_{ba}. \quad [9.54]$$

Equation 9.53 confirms what we already knew: that the transition rate for stimulated emission is the same as for absorption. But it was an astonishing result in 1917—indeed, Einstein was forced to “invent” stimulated emission in order to reproduce Planck's formula. Our present attention, however, focuses on Equation 9.54, for this tells us the spontaneous emission rate (A)—which is what we are looking for—in terms of the stimulated emission rate [$B_{ba}\rho(\omega_0)$]¹⁴—which we already know. From Equation 9.47 we read off

$$B_{ba} = \frac{\pi}{3\epsilon_0 \hbar^2} |\mathbf{p}|^2, \quad [9.55]$$

and it follows that the spontaneous emission rate is

$$A = \frac{\omega^3 |\mathbf{p}|^2}{3\pi \epsilon_0 \hbar c^3}. \quad [9.56]$$

¹³See, for example, Charles Kittel and Herbert Kroemer, *Thermal Physics*, 2nd ed. (New York: Freeman, 1980), Chapter 3.

Problem 9.8 As a mechanism for downward transitions, spontaneous emission competes with thermally stimulated emission (stimulated emission for which Planck radiation is the source). Show that at room temperature ($T = 300$ K) thermal stimulation dominates for frequencies well below 5×10^{12} Hz, whereas spontaneous emission dominates for frequencies well above 5×10^{12} Hz. Which mechanism dominates for visible light?

9.3.2 The Lifetime of an Excited State

Equation 9.56 is our fundamental result; it gives the transition rate for spontaneous emission. Suppose, now, that you have a bottle full of atoms, with $N_b(t)$ of them in the excited state. As a result of spontaneous emission, this number will decrease as time goes on; specifically, in a time interval dt you will lose a fraction $A dt$ of them:

$$dN_b = -AN_b dt \quad [9.57]$$

(assuming there is no mechanism to replenish the supply).¹⁴ Solving for $N_b(t)$, we find

$$N_b(t) = N_b(0)e^{-At}; \quad [9.58]$$

evidently the number remaining in the excited state decreases exponentially, with a time constant

$$\tau = \frac{1}{A}. \quad [9.59]$$

We call this the **lifetime** of the state—technically, it is the time it takes for $N_b(t)$ to reach $1/e \approx 0.368$ of its initial value.

I have assumed all along that there are only *two* states for the system, but this was just for notational simplicity—the spontaneous emission formula (Equation 9.56) gives the transition rate for $\psi_b \rightarrow \psi_a$ regardless of any other allowed states (see Problem 9.14). Typically, an excited atom has many different **decay modes** (that is, ψ_b can decay to a large number of different lower-energy states, $\psi_{a_1}, \psi_{a_2}, \psi_{a_3}, \dots$). In that case the transition rates *add*, and the net lifetime is

$$\tau = \frac{1}{A_1 + A_2 + A_3 + \dots}. \quad [9.60]$$

Example. Suppose a charge q is attached to a spring and constrained to oscillate along the x -axis. Say it starts out in the state $|n\rangle$ (Equation 2.50) and decays by spontaneous emission to state $|n'\rangle$. From Equation 9.44, we have

$$\mathbf{p} = q \langle n | x | n' \rangle \hat{i}.$$

¹⁴This situation is not to be confused with the case of thermal equilibrium, which we considered in the previous section. We assume here that the atoms have been lifted *out* of equilibrium, and are in the process of cascading back down to their equilibrium levels.

You calculated the matrix elements of x back in Problem 3.50:

$$\langle n|x|n'\rangle = \sqrt{\frac{\hbar}{2m\bar{\omega}}}(\sqrt{n'}\delta_{n,n'-1} + \sqrt{n}\delta_{n',n-1}),$$

where $\bar{\omega}$ is the natural frequency of the oscillator (I use the overbar to distinguish it from the frequency of the emitted radiation, although as we'll see in a moment the two turn out to be equal, and at that point I'll drop the bar). But we're talking about *emission*, so n' must be *lower* than n ; for our purposes, then,

$$\mathcal{D} = q\sqrt{\frac{n\hbar}{2m\bar{\omega}}}\delta_{n',n-1}\hat{i}. \quad [9.61]$$

Evidently transitions occur only to states one step lower on the "ladder," and the frequency of the photon emitted is

$$\omega = \frac{E_n - E_{n'}}{\hbar} = \frac{(n + 1/2)\hbar\bar{\omega} - (n' + 1/2)\hbar\bar{\omega}}{\hbar} = (n - n')\bar{\omega} = \bar{\omega}. \quad [9.62]$$

Not surprisingly, the system radiates at the classical oscillator frequency. The transition rate (Equation 9.56) is

$$A = \frac{nq^2\omega^2}{6\pi\epsilon_0 mc^3}, \quad [9.63]$$

and the lifetime of the n^{th} stationary state is

$$\tau_n = \frac{6\pi\epsilon_0 mc^3}{nq^2\omega^2}. \quad [9.64]$$

Meanwhile, each radiated photon carries an energy $\hbar\omega$, so the *power* radiated is $A\hbar\omega$:

$$P = \frac{q^2\omega^2}{6\pi\epsilon_0 mc^3}(n\hbar\omega),$$

or, since the energy of an oscillator in the n^{th} state is $E = (n + 1/2)\hbar\omega$,

$$P = \frac{q^2\omega^2}{6\pi\epsilon_0 mc^3}\left(E - \frac{1}{2}\hbar\omega\right). \quad [9.65]$$

This is the average power radiated by a quantum oscillator with (initial) energy E .

For comparison, let's determine the average power radiated by a *classical* oscillator with the same energy. According to classical electrodynamics, the power radiated by an accelerating charge q is given by the **Larmor formula**:¹⁵

$$P = \frac{q^2 a^2}{6\pi\epsilon_0 c^3}. \quad [9.66]$$

¹⁵See, for example, David J. Griffiths *Introduction to Electrodynamics*, 2nd ed. (Englewood Cliffs, NJ: Prentice-Hall, 1989), Section 9.1.4.

For a harmonic oscillator with amplitude x_0 , $x(t) = x_0 \cos(\omega t)$, and the acceleration is $a = -x_0 \omega^2 \cos(\omega t)$. Averaging over a full cycle, then,

$$P = \frac{q^2 x_0^2 \omega^4}{12\pi \epsilon_0 c^3}.$$

But the *energy* of the oscillator is $E = (1/2)m\omega^2 x_0^2$, so $x_0^2 = 2E/m\omega^2$, and hence

$$P = \frac{q^2 \omega^2}{6\pi \epsilon_0 m c^3} E. \quad [9.67]$$

This is the average power radiated by a *classical* oscillator with energy E . In the classical limit ($\hbar \rightarrow 0$) the classical and quantum formulas agree¹⁶; however, the quantum formula (Equation 9.65) protects the ground state: If $E = (1/2)\hbar\omega$ the oscillator does not radiate.

Problem 9.9 The *half-life* ($t_{1/2}$) of an excited state is the time it would take for half the atoms in a large sample to make a transition. Find the relation between $t_{1/2}$ and τ (the “lifetime” of the state).

*****Problem 9.10** Calculate the lifetime (in *seconds*) for each of the four $n = 2$ states of hydrogen. *Hint:* You’ll need to evaluate matrix elements of the form $\langle \psi_{100} | x | \psi_{200} \rangle$, $\langle \psi_{100} | y | \psi_{211} \rangle$, and so on. Remember that $x = r \sin \theta \cos \phi$, $y = r \sin \theta \sin \phi$, and $z = r \cos \theta$. Most of these integrals are zero, so scan them before you start calculating. *Answer:* 1.60×10^{-9} seconds for all except ψ_{200} , which is infinite.

9.3.3 Selection Rules

The calculation of spontaneous emission rates has been reduced to a matter of evaluating matrix elements of the form

$$\langle \psi_b | \mathbf{r} | \psi_a \rangle.$$

As you will have discovered if you worked Problem 9.10 (if you *didn’t*, go back right now and *do* so!), these quantities are very often *zero*, and it would be helpful to know *in advance* when this is going to happen, so we don’t waste a lot of time evaluating unnecessary integrals. Suppose we are interested in systems like hydrogen, for which the Hamiltonian is spherically symmetrical. In that case we may specify the states with the usual quantum numbers n , l , and m , and the matrix elements are

$$\langle n' l' m' | \mathbf{r} | n l m \rangle.$$

¹⁶In fact, if we express P in terms of the energy *above the ground state*, the two formulas are *identical*.

Clever exploitation of the angular momentum commutation relations and the hermiticity of the angular momentum operators yields a set of powerful constraints on this quantity.

Selection rules involving m and m' : Consider first the commutators of L_z with x , y , and z , which we worked out in Chapter 4 (see Equation 4.122):

$$[L_z, x] = i\hbar y, \quad [L_z, y] = -i\hbar x, \quad [L_z, z] = 0. \quad [9.68]$$

From the third of these it follows that

$$\begin{aligned} 0 &= \langle n'l'm' | [L_z, z] | nlm \rangle = \langle n'l'm' | (L_z z - z L_z) | nlm \rangle \\ &= \langle n'l'm' | [(m'\hbar)z - z(m\hbar)] | nlm \rangle = (m' - m)\hbar \langle n'l'm' | z | nlm \rangle. \end{aligned}$$

Conclusion:

$$\text{Either } m' = m, \text{ or else } \langle n'l'm' | z | nlm \rangle = 0. \quad [9.69]$$

So unless $m' = m$, the matrix elements of z are always zero.

Meanwhile, from the commutator of L_z with x we get

$$\begin{aligned} \langle n'l'm' | [L_z, x] | nlm \rangle &= \langle n'l'm' | (L_z x - x L_z) | nlm \rangle \\ &= (m' - m)\hbar \langle n'l'm' | x | nlm \rangle = i\hbar \langle n'l'm' | y | nlm \rangle. \end{aligned}$$

Conclusion:

$$(m' - m) \langle n'l'm' | x | nlm \rangle = i \langle n'l'm' | y | nlm \rangle \quad [9.70]$$

So you never have to compute matrix elements of y —you can always get them from the corresponding matrix elements of x .

Finally, the commutator of L_z with y yields

$$\begin{aligned} \langle n'l'm' | [L_z, y] | nlm \rangle &= \langle n'l'm' | (L_z y - y L_z) | nlm \rangle \\ &= (m' - m)\hbar \langle n'l'm' | y | nlm \rangle = -i\hbar \langle n'l'm' | x | nlm \rangle. \end{aligned}$$

Conclusion:

$$(m' - m) \langle n'l'm' | y | nlm \rangle = -i \langle n'l'm' | x | nlm \rangle \quad [9.71]$$

In particular, combining Equations 9.70 and 9.71,

$$(m' - m)^2 \langle n'l'm' | x | nlm \rangle = i(m' - m) \langle n'l'm' | y | nlm \rangle = \langle n'l'm' | x | nlm \rangle,$$

and hence

$$\text{either } (m' - m)^2 = 1, \text{ or else } \langle n'l'm' | x | nlm \rangle = \langle n'l'm' | y | nlm \rangle = 0. \quad [9.72]$$

From Equations 9.69 and 9.72 we obtain the **selection rule** for m :

$$\boxed{\text{No transitions occur unless } \Delta m = \pm 1 \text{ or } 0.} \quad [9.73]$$

This is an easy result to understand if you remember that the photon carries spin 1, and hence *its* value of m is 1, 0, or -1 ¹⁷; conservation of (the z -component of) angular momentum requires that the atom give up whatever the photon takes away.

Selection rules involving l and l' : In Problem 9.11 you are asked to derive the following commutation relation:

$$[L^2, [L^2, \mathbf{r}]] = 2\hbar^2(\mathbf{r}L^2 + L^2\mathbf{r}). \quad [9.74]$$

As before, we sandwich this commutator between $\langle n'l'm' |$ and $|nlm\rangle$ to derive the selection rule:

$$\begin{aligned} \langle n'l'm' | [L^2, [L^2, \mathbf{r}]] |nlm\rangle &= 2\hbar^2 \langle n'l'm' | (\mathbf{r}L^2 + L^2\mathbf{r}) |nlm\rangle \\ &= 2\hbar^4 [l(l+1) + l'(l'+1)] \langle n'l'm' | \mathbf{r} |nlm\rangle = \langle n'l'm' | (L^2[L^2, \mathbf{r}] - [L^2, \mathbf{r}]L^2) |nlm\rangle \\ &= \hbar^2 [l'(l'+1) - l(l+1)] \langle n'l'm' | [L^2, \mathbf{r}] |nlm\rangle \\ &= \hbar^2 [l'(l'+1) - l(l+1)] \langle n'l'm' | (L^2\mathbf{r} - \mathbf{r}L^2) |nlm\rangle \\ &= \hbar^4 [l'(l'+1) - l(l+1)]^2 \langle n'l'm' | \mathbf{r} |nlm\rangle. \end{aligned} \quad [9.75]$$

Conclusion:

$$\begin{aligned} \text{Either } 2[l(l+1) + l'(l'+1)] &= [l'(l'+1) - l(l+1)]^2 \\ \text{or else } \langle n'l'm' | \mathbf{r} |nlm\rangle &= 0. \end{aligned} \quad [9.76]$$

But

$$[l'(l'+1) - l(l+1)] = (l' + l + 1)(l' - l)$$

and

$$2[l(l+1) + l'(l'+1)] = (l' + l + 1)^2 + (l' - l)^2 - 1,$$

so the first condition in Equation 9.76 can be written

$$[(l' + l + 1)^2 - 1][(l' - l)^2 - 1] = 0. \quad [9.77]$$

¹⁷When the polar axis is along the direction of propagation, the middle value does not occur, and if you are only interested in the *number* of linearly independent photon states, the answer is 2, not 3. However, in this case the photon need not be going in the z -direction, and all three values are possible.

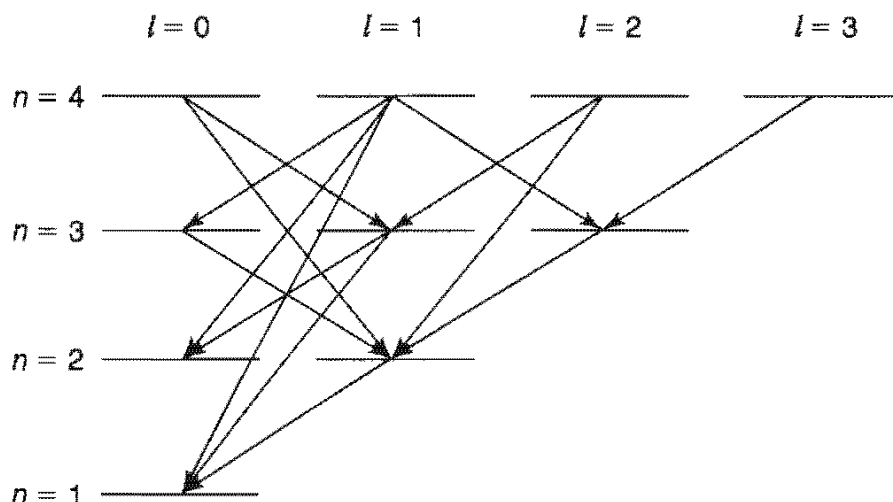

Figure 9.5: Allowed decays for the first four Bohr levels in hydrogen.

The first factor *cannot* be zero (unless $l' = l = 0$ —this loophole is closed in Problem 9.12), so the condition simplifies to $l' = l \pm 1$. Thus we obtain the selection rule for l :

$$\text{No transitions occur unless } \Delta l = \pm 1. \quad [9.78]$$

Again, this result (though scarcely trivial to *derive*) is easy to *interpret*: The photon carries spin 1, so the rules for addition of angular momentum would allow $l' = l + 1$, $l' = l$, or $l' = l - 1$ (for electric dipole radiation the middle possibility—though permitted by conservation of angular momentum—does not occur).

Evidently not all transitions to lower-energy states can proceed by spontaneous emission; some are forbidden by the selection rules. The scheme of allowed transitions for the first four Bohr levels in hydrogen is shown in Figure 9.5. Note that the $2S$ state (ψ_{200}) is “stuck”: It cannot decay, because there is no lower-energy state with $l = 1$. It is called a **metastable** state, and its lifetime is indeed much longer than that of, for example, the $2P$ states (ψ_{211} , ψ_{210} , and ψ_{21-1}). Metastable states do eventually decay, either by collisions or by what are (misleadingly) called **forbidden** transitions (Problem 9.20), or by multiphoton emission.

****Problem 9.11** Prove the commutation relation Equation 9.74. *Hint*: First show that

$$[L^2, z] = 2i\hbar(xL_y - yL_x - i\hbar z).$$

Use this and the fact that $\mathbf{r} \cdot \mathbf{L} = \mathbf{r} \cdot (\mathbf{r} \times \mathbf{p}) = 0$ to demonstrate that

$$[L^2, [L^2, z]] = 2\hbar^2(zL^2 + L^2z).$$

The generalization from z to \mathbf{r} is trivial.

Problem 9.12 Plug the “loophole” in Equation 9.78 by showing that if $l' = l = 0$ then $\langle n'l'm' | \mathbf{r} | nlm \rangle = 0$.

****Problem 9.13** An electron in the $n = 3, l = 0, m = 0$ state of hydrogen decays by a sequence of (electric dipole) transitions to the ground state.

(a) What decay routes are open to it? Specify them in the following way:

$$|300\rangle \rightarrow |nlm\rangle \rightarrow |n'l'm'\rangle \rightarrow \dots \rightarrow |100\rangle.$$

(b) If you had a bottle full of atoms in this state, what fraction of them would decay via each route?

(c) What is the lifetime of this state? *Hint:* Once it's made the first transition, it's no longer in the state $|300\rangle$, so only the *first* step in each sequence is relevant in computing the lifetime. When there is more than one decay route open, the transition *rates* add.

FURTHER PROBLEMS FOR CHAPTER 9

**** Problem 9.14** Develop time-dependent perturbation theory for a multilevel system, starting with the generalization of Equations 9.1 and 9.2:

$$H_0 \psi_n = E_n \psi_n, \quad \langle \psi_n | \psi_m \rangle = \delta_{nm}. \quad [9.79]$$

At time $t = 0$ we turn on a perturbation $H'(t)$, so that the total Hamiltonian is

$$H = H_0 + H'(t). \quad [9.80]$$

(a) Generalize Equation 9.6 to read

$$\Psi(t) = \sum c_n(t) \psi_n e^{-iE_n t/\hbar}, \quad [9.81]$$

and show that

$$\dot{c}_m = -\frac{i}{\hbar} \sum_n c_n H'_{mn} e^{i(E_m - E_n)t/\hbar}, \quad [9.82]$$

where

$$H'_{mn} \equiv \langle \psi_m | H' | \psi_n \rangle. \quad [9.83]$$

(b) If the system starts out in the state ψ_N , show that (in first-order perturbation theory)

$$c_N(t) \cong 1 - \frac{i}{\hbar} \int_0^t H'_{NN}(t') dt' \quad [9.84]$$

and

$$c_m(t) \cong -\frac{i}{\hbar} \int_0^t H'_{mN}(t') e^{i(E_m - E_N)t'/\hbar} dt', \quad (m \neq N). \quad [9.85]$$

- (c) For example, suppose H' is *constant* (except that it was turned on at $t = 0$ and switched off again at some later time t). Find the probability of transition from state N to state m ($m \neq N$), as a function of t . *Answer:*

$$4|H'_{mN}|^2 \frac{\sin^2[(E_N - E_m)t/2\hbar]}{(E_N - E_m)^2}. \quad [9.86]$$

- (d) Now suppose H' is a sinusoidal function of time: $H' = V \cos(\omega t)$. Making the usual assumptions, show that transitions occur only to states with energy $E_m = E_N \pm \hbar\omega$, and the transition probability is

$$P_{N \rightarrow m} = |V_{mN}|^2 \frac{\sin^2[(E_N - E_m \pm \hbar\omega)t/2\hbar]}{(E_N - E_m \pm \hbar\omega)^2}. \quad [9.87]$$

- (e) Suppose a multilevel system is immersed in incoherent electromagnetic radiation. Using Section 9.2.3 as a guide, show that the transition rate for stimulated emission is given by the same formula (Equation 9.47) as for a two-level system.

Problem 9.15 For the examples in Problem 9.14 (c) and (d), calculate $c_m(t)$, to first order. Check the normalization condition:

$$\sum_m |c_m(t)|^2 = 1, \quad [9.88]$$

and comment on any discrepancy. Suppose you wanted to calculate the probability of *remaining* in the original state ψ_N ; would you do better to use $|c_N(t)|^2$, or $1 - \sum_{m \neq N} |c_m(t)|^2$?

Problem 9.16 A particle starts out (at time $t = 0$) in the N^{th} state of the infinite square well. Now water leaks into the well, and then drains out again, so that the bottom is at uniform potential $V_0(t)$, with $V_0(0) = V_0(T) = 0$.

- (a) Solve the *exact* equation (Equation 9.82) for $c_m(t)$, and show that the wave function changes *phase*, but no transitions to other states occur. Find the phase change $\phi(T)$ in terms of the function $V_0(t)$.
- (b) Analyze the same problem in first-order perturbation theory, and compare your answers.

Note: The same result holds *whenever* the perturbation simply adds a constant (constant in x , that is, not in t) to the potential; it has nothing to do with the infinite square well as such. See Problem 1.13.

***Problem 9.17** A particle of mass m is initially in the ground state of the (one-dimensional) infinite square well. At time $t = 0$ a “brick” is dropped into the well, so that the potential becomes

$$V(x) = \begin{cases} V_0, & \text{if } 0 \leq x \leq a/2, \\ 0, & \text{if } a/2 < x \leq a, \\ \infty, & \text{otherwise,} \end{cases}$$

where $V_0 \ll E_1$. After a time T , the brick is removed, and the energy of the particle is measured. Find the probability (in first-order perturbation theory) that the energy is now E_2 .

Problem 9.18 Justify the following version of the energy-time uncertainty principle (due to Landau): $\Delta E \Delta t \geq \hbar/2$, where Δt is the time it takes to execute a transition involving an energy change ΔE , under the influence of a constant perturbation (see Problem 9.14c.) Explain more precisely what ΔE and Δt mean in this context.

*****Problem 9.19** An electron is at rest at the origin, in the presence of a magnetic field whose *magnitude* (B_0) is constant but whose *direction* rides around at constant angular velocity ω on the lip of a cone of opening angle α :

$$\mathbf{B}(t) = B_0[\sin \alpha \cos(\omega t)\hat{i} + \sin \alpha \sin(\omega t)\hat{j} + \cos \alpha \hat{k}]. \quad [9.89]$$

- (a) Construct the 2×2 Hamiltonian matrix (Equation 4.158) for this system.
 (b) Find the *exact* solution to the (time-dependent) Schrödinger equation, assuming the particle starts out with spin up. *Hint*: You can do it from scratch, or by noting that in this case the rotating wave approximation is *exact*, and referring to Problem 9.7. *Answer*:

$$\chi(t) = \begin{pmatrix} [\cos(\lambda t/2) + i[(\omega + \omega_1 \cos \alpha)/\lambda] \sin(\lambda t/2)] e^{-i\omega t/2} \\ i[(\omega_1 \sin \alpha)/\lambda] \sin(\lambda t/2) e^{i\omega t/2} \end{pmatrix}, \quad [9.90]$$

where

$$\omega_1 \equiv -eB_0/m \quad \text{and} \quad \lambda \equiv \sqrt{\omega^2 + \omega_1^2 + 2\omega\omega_1 \cos \alpha}. \quad [9.91]$$

- (c) Now treat the same problem by (first-order) time-dependent perturbation theory: use Equation 9.17 to calculate the (approximate) probability of a transition from spin up (the initial state) to spin down, as a function of time, and compare the exact answer (from part b). State the criterion on the strength of the field that determines whether perturbation theory is applicable in this case.

*****Problem 9.20** In Equation 9.31 we assumed that the atom is so small (in comparison to the wavelength of light) that spatial variations in the field can be ignored. The *true* electric field would be

$$\mathbf{E}(\mathbf{r}, t) = \mathbf{E}_0 \cos(\mathbf{k} \cdot \mathbf{r} - \omega t). \quad [9.92]$$

If the atom is centered at the origin, then $\mathbf{k} \cdot \mathbf{r} \ll 1$ over the relevant volume ($|\mathbf{k}| = 2\pi/\lambda$, so $\mathbf{k} \cdot \mathbf{r} \sim r/\lambda \ll 1$), and that's why we could afford to drop this term. Suppose we keep the first-order correction:

$$\mathbf{E}(\mathbf{r}, t) = \mathbf{E}_0[\cos(\omega t) + (\mathbf{k} \cdot \mathbf{r}) \sin(\omega t)]. \quad [9.93]$$

The first term gives rise to the **allowed (electric dipole)** transitions we considered in the text; the second gives rise to so-called **forbidden (magnetic dipole and electric quadrupole)** transitions (higher powers of $\mathbf{k} \cdot \mathbf{r}$ lead to even *more* “forbidden” transitions, associated with higher multipole moments¹⁸).

- (a) Obtain the spontaneous emission rate for forbidden transitions (don't bother to average over polarization and propagation directions, though this should really be done to complete the calculation). *Answer:*

$$R_{b \rightarrow a} = \frac{q^2 \omega^5}{\pi \epsilon_0 \hbar c^5} |\langle a | (\hat{\mathbf{n}} \cdot \mathbf{r})(\hat{\mathbf{k}} \cdot \mathbf{r}) | b \rangle|^2. \quad [9.94]$$

- (b) Show that for a one-dimensional oscillator, the forbidden transitions go from level n to level $n - 2$, and the transition rate (suitably averaged over $\hat{\mathbf{n}}$ and $\hat{\mathbf{k}}$) is

$$R = \frac{\hbar q^2 \omega^3 n(n-1)}{15\pi \epsilon_0 m^2 c^5}. \quad [9.95]$$

Find the *ratio* of the “forbidden” rate to the “allowed” rate, and comment on the terminology. (*Note:* ω is the frequency of the *photon*, not the *oscillator*.)

- (c) Show that the $2S \rightarrow 1S$ transition in hydrogen is not possible even by a “forbidden” transition. (As it turns out, this is true for all the higher multipoles as well; the dominant decay is in fact by a two-photon emission, and the lifetime is about a tenth of a second.¹⁹)

Problem 9.21 We have encountered stimulated emission, (stimulated) absorption, and spontaneous emission ... how come there's no such thing as spontaneous *absorption*?

¹⁸For a systematic treatment (including the role of the magnetic field), see David Park, *Introduction to the Quantum Theory*, 3rd ed. (New York: McGraw-Hill, 1992), Chapter 11.

¹⁹See Masataka Mizushima, *Quantum Mechanics of Atomic Spectra and Atomic Structure*, New York: Benjamin, 1970), Section 5.6.

CHAPTER 10

THE ADIABATIC APPROXIMATION

10.1 THE ADIABATIC THEOREM

10.1.1 Adiabatic Processes

Imagine a perfect pendulum, with no friction or air resistance, oscillating back and forth in a vertical plane. If I grab the support and shake it in a jerky manner, the bob will swing around in a wild chaotic fashion. But if I *very gently and steadily* move the support (Figure 10.1), the pendulum will continue to swing in a nice, smooth way, in the same plane (or one parallel to it) with the same amplitude. This *gradual change in the external conditions* characterizes an **adiabatic** process. Notice that there are two characteristic times involved: T_i , the “internal” time, representing the motion of the system itself (in this case the period of the pendulum’s oscillations), and T_e , the “external” time, over which the parameters of the system change appreciably (if the pendulum were mounted on an oscillating platform, for example, T_e would be the period of the *platform’s* motion). An adiabatic process is one for which $T_e \gg T_i$.¹

The basic strategy for analyzing an adiabatic process is first to solve the problem with the external parameters held *fixed*, and only at the *end* of the calculation allow them to change with time. For example, the classical period of a pendulum of (constant) length L is $2\pi\sqrt{L/g}$; if the length is now gradually *changing*, the

¹For an interesting discussion of classical adiabatic processes, see Frank S. Crawford, *Am. J. Phys.* **58**, 337 (1990).

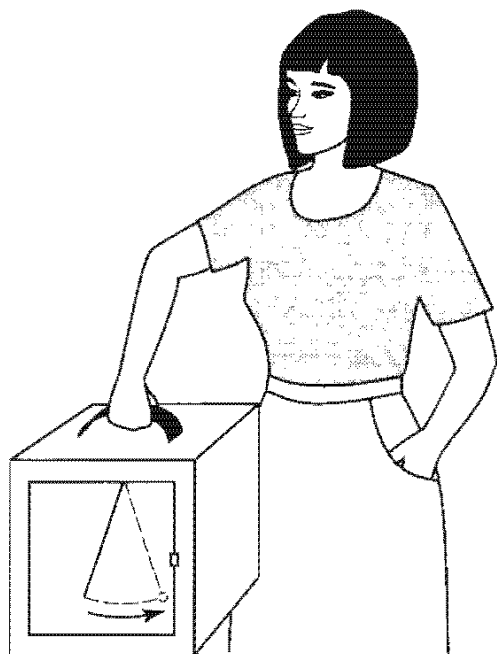

Figure 10.1: Adiabatic motion: If the case is transported very gradually, the pendulum inside keeps swinging with the same amplitude, in a plane parallel to the original one.

period will presumably be $2\pi\sqrt{L(t)/g}$. When you stop to think about it, we actually *use* the adiabatic approximation (implicitly) all the time without noticing it. A case in point is our discussion of the hydrogen molecule ion (Section 7.3). We began by assuming that the nuclei were *at rest*, a fixed distance R apart, and we solved for the motion of the electron. Once we had found the ground state energy of the system as a function of R , we located the equilibrium separation and from the curvature of the graph we obtained the frequency of vibration of the nuclei (Problem 7.10). In molecular physics this technique (beginning with nuclei at rest, calculating electronic wave functions, and using these to obtain information about the positions and—relatively sluggish—motion of the nuclei) is known as the **Born-Oppenheimer approximation**.

In quantum mechanics, the essential content of the **adiabatic approximation** can be cast in the form of a theorem. Suppose that the Hamiltonian changes *gradually* from some initial form H^i to some final form H^f (Figure 10.2). The **adiabatic theorem** states that if the particle was initially in the n th eigenstate of H^i , it will be

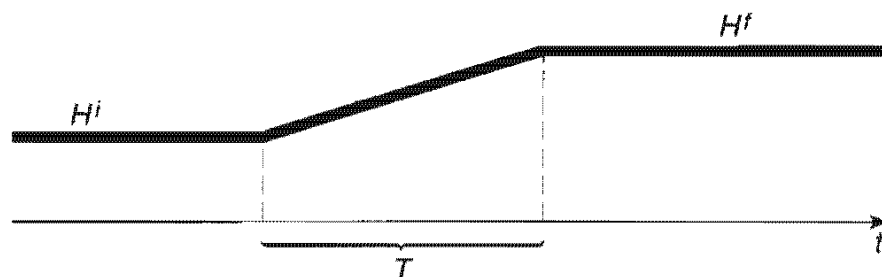

Figure 10.2: A model for adiabatic change in the Hamiltonian, from H^i to H^f .

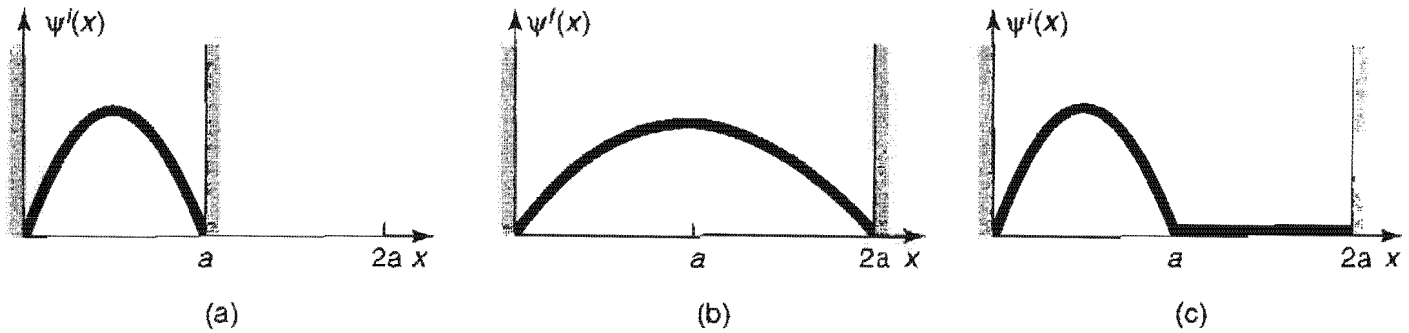

Figure 10.3: (a) Particle starts out in the ground state of the infinite square well. (b) If the wall moves *slowly*, the particle remains in the ground state. (c) If the wall moves *rapidly*, the particle is left (momentarily) in its initial state.

carried (under the Schrödinger equation) into the n th eigenstate of H^f . (I assume that the spectrum is discrete and nondegenerate throughout the transition from H^i to H^f , so there is no ambiguity about the ordering of the states; these conditions can be relaxed, given a suitable procedure for “tracking” the eigenfunctions, but I’m not going to pursue that here.)

For example, suppose we prepare a particle in the ground state of the infinite square well (Figure 10.3a):

$$\psi^i(x) = \sqrt{\frac{2}{a}} \sin\left(\frac{\pi}{a}x\right). \quad [10.1]$$

If we now gradually move the right wall out to $2a$, the adiabatic theorem says that the particle will end up in the ground state of the expanded well (Figure 10.3b):

$$\psi^f(x) = \sqrt{\frac{1}{a}} \sin\left(\frac{\pi}{2a}x\right) \quad [10.2]$$

(apart, perhaps, from a phase factor). Notice that we’re not talking about a *small* change in the Hamiltonian (as in perturbation theory)—this one is a *huge* change. All we require is that it happen *slowly*. By contrast, if the well expands *suddenly*, the resulting state is still $\psi^i(x)$ (Figure 10.3c), which is a complicated linear combination of eigenstates of the new Hamiltonian (Problem 3.48).

*****Problem 10.1** The case of an infinite square well whose right wall expands at a constant velocity (v) can be solved *exactly*.² A complete set of solutions is

$$\Phi_n(x, t) \equiv \sqrt{\frac{2}{w}} \sin\left(\frac{n\pi}{w}x\right) e^{i(mvx^2 - 2E_n^i t)/2\hbar w}, \quad [10.3]$$

where $w(t) \equiv a + vt$ is the width of the well and $E_n^i \equiv n^2\pi^2\hbar^2/2ma^2$ is the n th allowed

²S. W. Doescher and M. H. Rice, *Am. J. Phys.* 37, 1246 (1969).

energy of the *original* well (width a). The *general* solution is a linear combination of the Φ 's:

$$\Psi(x, t) = \sum_{n=1}^{\infty} c_n \Phi_n(x, t); \quad [10.4]$$

the coefficients c_n are *independent of t* .

- (a) Check that Equation 10.3 satisfies the time-dependent Schrödinger equation, with the appropriate boundary conditions.
- (b) Suppose a particle starts out ($t = 0$) in the ground state of the initial well:

$$\Psi(x, 0) = \sqrt{\frac{2}{a}} \sin\left(\frac{\pi}{a}x\right).$$

Show that the expansion coefficients can be written in the form

$$c_n = \frac{2}{\pi} \int_0^{\pi} e^{-i\alpha z^2} \sin(nz) \sin(z) dz, \quad [10.5]$$

where $\alpha \equiv mva/2\pi^2\hbar$ is a dimensionless measure of the speed with which the well expands. (Unfortunately, this integral cannot be evaluated in terms of elementary functions.)

- (c) Suppose we allow the well to expand to twice its original width, so the “external” time is given by $w(T_e) = 2a$. The “internal” time is the *period* of the time-dependent exponential factor in the (initial) ground state. Determine T_e and T_i , and show that the adiabatic regime corresponds to $\alpha \ll 1$, so that $e^{-i\alpha z^2} \cong 1$ over the domain of integration. Use this to determine the expansion coefficients c_n . Construct $\Psi(x, t)$, and confirm that it is consistent with the adiabatic theorem.
- (d) Show that the phase factor in $\Psi(x, t)$ can be written in the form

$$\theta(t) = -\frac{1}{\hbar} \int_0^t E_1(t') dt', \quad [10.6]$$

where $E_n(t) \equiv n^2\pi^2\hbar^2/2mw^2$ is the n^{th} *instantaneous* eigenvalue, at time t . Comment on this result.

10.1.2 Proof of the Adiabatic Theorem

The adiabatic theorem is simple to state, and it *sounds* plausible, but it is not easy to prove.³ Suppose the time-dependent part of the Hamiltonian can be written in the form⁴

$$H'(t) = V f(t), \quad [10.7]$$

where $f(t)$ is a function that starts out zero (at $t = 0$) and increases to 1 (at $t = T$), Figure 10.4. Assume that the particle starts out in the n^{th} eigenstate of the original Hamiltonian:

$$\Psi(0) = \psi_n^i \quad [10.8]$$

and evolves into some state $\Psi(t)$. Our problem is to show that if the function $f(t)$ rises *very gradually*, then the probability that the particle, at time T , is in the n^{th} eigenstate of the *final* Hamiltonian (ψ_n^f) is 1. More precisely, we must demonstrate that

$$|\langle \Psi(T) | \psi_m^f \rangle|^2 = \begin{cases} 1, & \text{if } m = n, \\ 0, & \text{if } m \neq n. \end{cases} \quad [10.9]$$

(Of course, if the first of these is true, the second *has* to be, and vice versa. But it is not clear at this stage which condition will be easier to prove.)

Assume for the moment that V is *small*, so we can use first-order time-independent perturbation theory to determine ψ_m^f . From Equation 6.12,

$$\psi_m^f \cong \psi_m + \sum_{k \neq m} \frac{V_{km}}{E_m - E_k} \psi_k, \quad [10.10]$$

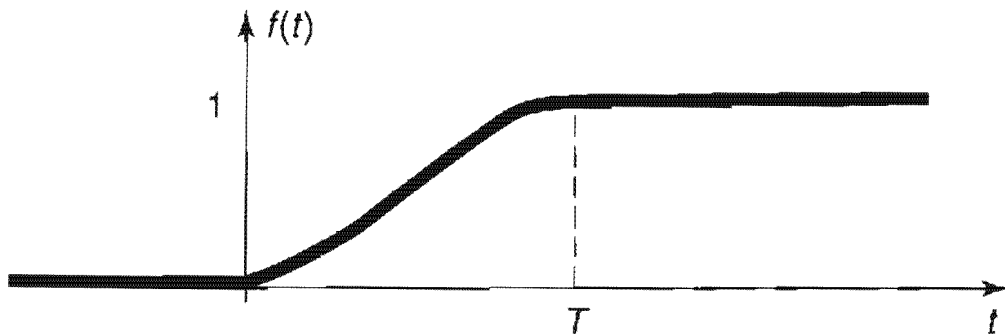

Figure 10.4: The function $f(t)$, in Equation 10.7.

³The adiabatic theorem is usually attributed to Ehrenfest, who studied adiabatic processes in early versions of the quantum theory. The first proof in modern quantum mechanics was given by Born and Fock, *Zeit. f. Physik* **51**, 165 (1928). Other proofs will be found in Messiah, *Quantum Mechanics* (New York: John Wiley & Sons, 1962), Vol. II, Chapter XVII, Section 12, and J-T. Hwang and Philip Pechukas, *J. Chem. Phys.* **67**, 4640 (1977). The argument given here is suggested by Gasiorowicz, *Quantum Physics* (New York: John Wiley & Sons, 1974), Chapter 22, Problem 6.

⁴The assumption that H' is the *product* of an operator (V) and a (real) function of t is not necessary for the theorem itself, but it does make the proof less cumbersome. In Section 10.1.3 we will encounter a case in which the different matrix elements of H' have *different* (complex) time dependences. As long as the adiabatic approximation (in the form of Equation 10.15) holds for *each* of them, the adiabatic theorem itself is valid.

where

$$V_{km} \equiv \langle \psi_k | V | \psi_m \rangle. \quad [10.11]$$

(To simplify the notation, I'll drop the superscript i on eigenfunctions and eigenvalues of the initial Hamiltonian; these are the "unperturbed" states for the problem.)

Meanwhile, we use first-order time-dependent perturbation theory to determine $\Psi(T)$. From Equation 9.81,

$$\Psi(t) = \sum_l c_l(t) \psi_l e^{-iE_l t/\hbar}, \quad [10.12]$$

where (Equation 9.84)

$$c_n(t) \cong 1 - \frac{i}{\hbar} V_{nn} \int_0^t f(t') dt' \quad [10.13]$$

and (Equation 9.85)

$$c_l(t) \cong -\frac{i}{\hbar} V_{ln} \int_0^t f(t') e^{i(E_l - E_n)t'/\hbar} dt', \quad l \neq n. \quad [10.14]$$

This last integral can be evaluated using integration by parts. Note that

$$e^{i(E_l - E_n)t'/\hbar} = \frac{-i\hbar}{E_l - E_n} \frac{d}{dt'} \left[e^{i(E_l - E_n)t'/\hbar} \right],$$

so

$$\begin{aligned} c_l(t) &\cong -\frac{V_{ln}}{E_l - E_n} \int_0^t f(t') \frac{d}{dt'} \left[e^{i(E_l - E_n)t'/\hbar} \right] dt' \\ &= -\frac{V_{ln}}{E_l - E_n} \left\{ f(t) e^{i(E_l - E_n)t/\hbar} - \int_0^t \frac{df}{dt'} e^{i(E_l - E_n)t'/\hbar} dt' \right\}. \end{aligned}$$

[I dropped the lower limit in the first term, because $f(0) = 0$.] Now comes the adiabatic approximation: We want $f(t)$ to be a *very gradual* function, so that df/dt is extremely small. Specifically, we assume that

$$\frac{df}{dt} \ll \frac{|E_l - E_n|}{\hbar} f; \quad [10.15]$$

then the last term makes a negligible contribution to $c_l(t)$, and we conclude that

$$\Psi(T) \cong \left[\left(1 - i \frac{V_{nn} A}{\hbar} \right) \psi_n - \sum_{l \neq n} \frac{V_{ln}}{E_l - E_n} \psi_l \right] e^{-iE_n T/\hbar}, \quad [10.16]$$

where A is the area under the graph of $f(t)$, from 0 to T .

Putting together Equations 10.10 and 10.16, and exploiting the orthonormality of the initial eigenfunctions, we find that

$$\langle \Psi(T) | \psi_n^f \rangle = \left[1 + i \frac{V_{nn} A}{\hbar} + \sum_{k \neq n} \frac{|V_{kn}|^2}{(E_n - E_k)^2} \right] e^{i E_n T / \hbar}, \quad [10.17]$$

while, for $m \neq n$,

$$\begin{aligned} \langle \Psi(T) | \psi_m^f \rangle &= \left\{ \left[1 + i \frac{V_{nn} A}{\hbar} \right] \frac{V_{nm}}{E_m - E_n} \right. \\ &\quad \left. - \frac{V_{nm}}{E_m - E_n} + \sum_{n \neq k \neq m} \frac{V_{nk} V_{km}}{(E_n - E_k)(E_m - E_k)} \right\} e^{i E_n T / \hbar} \\ &= \left[\frac{i A V_{nn} V_{nm}}{\hbar (E_m - E_n)} + \sum_{n \neq k \neq m} \frac{V_{nk} V_{km}}{(E_n - E_k)(E_m - E_k)} \right] e^{i E_n T / \hbar}. \end{aligned} \quad [10.18]$$

But wait: These wave functions were only accurate to *first* order in V , so the *second*-order terms in Equations 10.17 and 10.18 are spurious (we have already thrown away quantities of comparable size). To *first* order, we have

$$\langle \Psi(T) | \psi_m^f \rangle = \begin{cases} \left[1 + i \frac{V_{nn} A}{\hbar} \right] e^{i E_n T / \hbar}, & m = n, \\ 0 & m \neq n. \end{cases} \quad [10.19]$$

It follows that

$$|\langle \Psi(T) | \psi_n^f \rangle|^2 = 1, \quad [10.20]$$

while (for $m \neq n$)

$$|\langle \Psi(T) | \psi_m^f \rangle|^2 = 0. \quad [10.21]$$

Ostensibly, *either* of these would suffice to establish the desired result (Equation 10.9). However, Equation 10.20 is only accurate to *first* order (in V), whereas Equation 10.21 is accurate to *second* order (and for that matter to *third* order as well).⁵ In truth, Equation 10.20 tells us *nothing* (it would be valid also for a *nonadiabatic* transformation); the *crucial* point is the cancellation of the first-order terms in Equation 10.18, for this tells us that there will be no transitions to other states.⁶

⁵See Problem 9.15 for a discussion of the analogous situation in ordinary perturbation theory.

⁶In this context the word “transition” means from an eigenstate ψ_n^i of the *initial* Hamiltonian (H^i) to a different eigenstate ψ_m^f of the *final* Hamiltonian (H^f). The adiabatic theorem says that if the Hamiltonian changes *gradually* from H^i to H^f , there will be *no* such transitions. By contrast, in the previous chapter we were always dealing with eigenstates of the *same* (unperturbed) Hamiltonian. At the end of the process the perturbation was (explicitly or implicitly) turned off, and a “transition” meant from one eigenstate of the unperturbed Hamiltonian to another eigenstate of the unperturbed Hamiltonian. The transition amplitudes were of *first* order in H' (Equations 9.17 and 9.85) and the transition probabilities of *second* order (for example, Equations 9.28, 9.86, and 9.87). The essence of the adiabatic theorem (as we shall see in the next paragraph) is that the transition amplitudes are only *second* order, and the transition probabilities *fourth* order in the (small) perturbation.

This shows that if the change in the Hamiltonian is both adiabatic *and* very small (so that first-order perturbation theory can be applied), then there will be no transitions. But what if the change, though gradual, is *not* small? In that case we chop the interval T into N subintervals, so that the change in the Hamiltonian during a single subinterval (ΔV) is of order V/N ; if N is large, then ΔV is small, and we can apply the previous argument to each subinterval. If the transition amplitude (Equation 10.18) were *first* order in the perturbation, then the *total* transition amplitude would go like

$$N \left(\frac{V}{N} \right) \rightarrow V \quad [10.22]$$

(N steps, each making a contribution proportional to ΔV). The net result would be of order V , and if V is large, so too would be the transition amplitude. But *in fact* the transition amplitude is *second* order, so the total goes like

$$N \left(\frac{V}{N} \right)^2 \rightarrow \frac{V^2}{N} \quad [10.23]$$

In the limit as $N \rightarrow \infty$, the transition amplitude goes to zero, *regardless* of the size of V . QED

Problem 10.2 In the beginning of this chapter, I characterized an adiabatic process informally as one for which $T_e \gg T_i$. How is this related to the precise condition (Equation 10.15) required in the proof (in other words, what are T_e and T_i here)?

10.1.3 An Example

Imagine an electron (charge $-e$, mass m) at rest at the origin, in the presence of a magnetic field whose *magnitude* (B_0) is constant but whose *direction* sweeps out a cone, of opening angle α , at constant angular velocity ω (Figure 10.5):

$$\mathbf{B}(t) = B_0[\sin \alpha \cos(\omega t)\hat{i} + \sin \alpha \sin(\omega t)\hat{j} + \cos \alpha \hat{k}]. \quad [10.24]$$

The Hamiltonian (Equation 4.158) is

$$\begin{aligned} H(t) &= \frac{e}{m} \mathbf{B} \cdot \mathbf{S} = \frac{e\hbar B_0}{2m} [\sin \alpha \cos(\omega t)\sigma_x + \sin \alpha \sin(\omega t)\sigma_y + \cos \alpha \sigma_z] \\ &= -\frac{\hbar\omega_1}{2} \begin{pmatrix} \cos \alpha & e^{-i\omega t} \sin \alpha \\ e^{i\omega t} \sin \alpha & -\cos \alpha \end{pmatrix}, \end{aligned} \quad [10.25]$$

where

$$\omega_1 \equiv -\frac{eB_0}{m}. \quad [10.26]$$

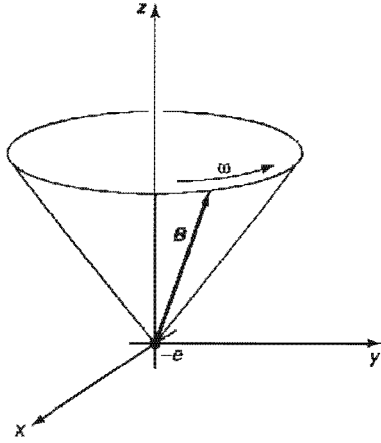

Figure 10.5: Magnetic field sweeps around on a cone, at angular velocity ω , Equation 10.24.

The normalized eigenspinors of $H(t)$ are

$$\chi_+(t) = \begin{pmatrix} \cos(\alpha/2) \\ e^{i\omega t} \sin(\alpha/2) \end{pmatrix} \quad [10.27]$$

and

$$\chi_-(t) = \begin{pmatrix} \sin(\alpha/2) \\ -e^{i\omega t} \cos(\alpha/2) \end{pmatrix}; \quad [10.28]$$

they represent spin up and spin down, respectively, *along the instantaneous direction of $\mathbf{B}(t)$* (see Problem 4.31). The corresponding eigenvalues are

$$E_{\pm} = \mp \frac{\hbar\omega_1}{2}. \quad [10.29]$$

Suppose the electron starts out with spin up, along $\mathbf{B}(0)$:

$$\chi(0) = \begin{pmatrix} \cos(\alpha/2) \\ \sin(\alpha/2) \end{pmatrix}. \quad [10.30]$$

The exact solution to the time-dependent Schrödinger equation is (Problem 10.3)

$$\chi(t) = \begin{pmatrix} \left[\cos(\lambda t/2) + i \frac{(\omega_1 + \omega)}{\lambda} \sin(\lambda t/2) \right] \cos(\alpha/2) e^{-i\omega t/2} \\ \left[\cos(\lambda t/2) + i \frac{(\omega_1 - \omega)}{\lambda} \sin(\lambda t/2) \right] \sin(\alpha/2) e^{i\omega t/2} \end{pmatrix}, \quad [10.31]$$

where

$$\lambda \equiv \sqrt{\omega^2 + \omega_1^2 + 2\omega\omega_1 \cos \alpha}, \quad [10.32]$$

or, writing it as a linear combination of χ_+ and χ_- ,

$$\begin{aligned} \chi(t) = & \left[\cos\left(\frac{\lambda t}{2}\right) + i \frac{(\omega_1 + \omega \cos \alpha)}{\lambda} \sin\left(\frac{\lambda t}{2}\right) \right] e^{-i\omega t/2} \chi_+(t) \\ & + i \left[\frac{\omega}{\lambda} \sin \alpha \sin\left(\frac{\lambda t}{2}\right) \right] e^{-i\omega t/2} \chi_-(t). \end{aligned} \quad [10.33]$$

Evidently the (exact) probability of a transition to spin down (along the current direction of \mathbf{B}) is

$$|\langle \chi(t) | \chi_-(t) \rangle|^2 = \left[\frac{\omega}{\lambda} \sin \alpha \sin \left(\frac{\lambda t}{2} \right) \right]^2. \quad [10.34]$$

The adiabatic theorem says that this transition probability should vanish in the limit $T_e \gg T_i$, where T_e is the characteristic time for changes in the Hamiltonian (in this case, $1/\omega$) and T_i is the characteristic time for changes in the wave function [in this case, $\hbar/(E_+ - E_-) = 1/\omega_1$]. Thus the adiabatic approximation means $\omega \ll \omega_1$: The field rotates slowly, in comparison with the phase of the (unperturbed) wave functions. In the adiabatic regime $\lambda \cong \omega_1$, and therefore

$$|\langle \chi(t) | \chi_-(t) \rangle|^2 \cong \left[\frac{\omega}{\omega_1} \sin \alpha \sin \left(\frac{\lambda t}{2} \right) \right]^2 \rightarrow 0, \quad [10.35]$$

as advertised. The magnetic field leads the electron around by its nose, with the spin always pointing in the direction of \mathbf{B} . By contrast, if $\omega \gg \omega_1$ then $\lambda \cong \omega$, and the system bounces back and forth between spin up and spin down (Figure 10.6).

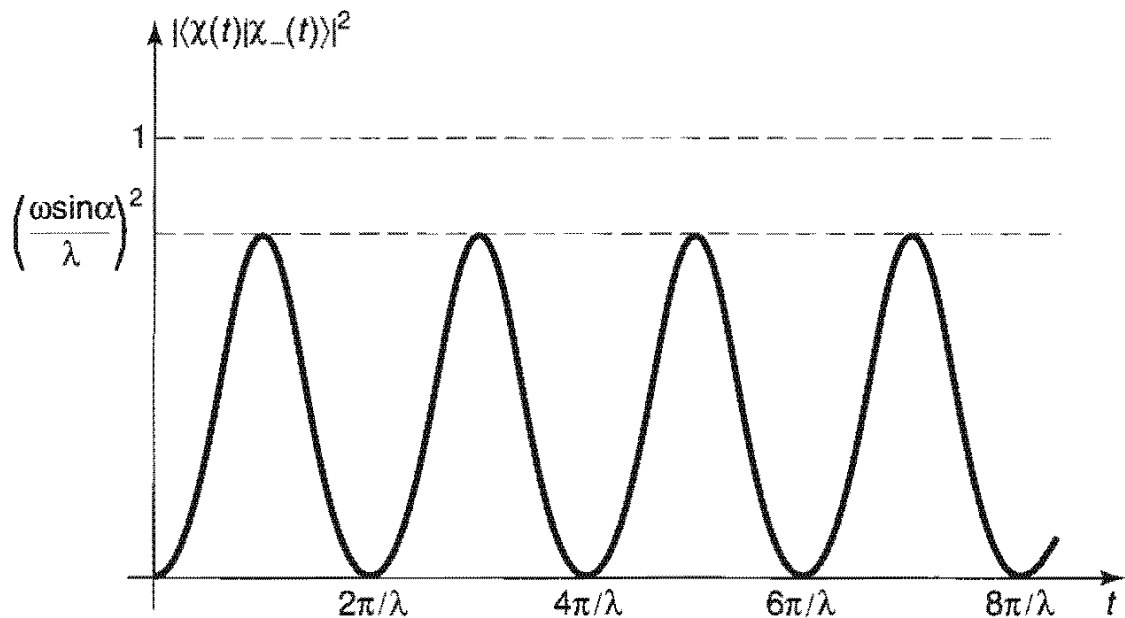

Figure 10.6: Plot of the transition probability, Equation 10.34, in the *nonadiabatic* regime ($\omega \ll \omega_1$).

****Problem 10.3** Check that Equation 10.31 satisfies the time-dependent Schrödinger equation for the Hamiltonian (Equation 10.25). *Note:* This is the same as Problem 9.19(b), except that now the electron starts out with spin up along \mathbf{B} , whereas in Equation 9.90 it started out with spin up along z . Also confirm Equation 10.33, and show that the sum of the squares of the coefficients is 1, as required for proper normalization.

10.2 Berry's Phase

10.2.1 Nonholonomic Processes

Let us return to the classical model I used (in Section 10.1.1) to develop the notion of an *adiabatic* process: a perfectly frictionless pendulum whose support is carried around from place to place. I claimed that as long as the motion of the support is *very slow*, compared to the period of the pendulum (so that the pendulum executes many oscillations before the support has moved appreciably), it will continue to swing in the same plane (or one parallel to it), with the same amplitude (and, of course, the same frequency).

But what if I took this ideal pendulum up to the North Pole, and set it swinging—say, in the direction of Portland (Figure 10.7). (For the moment, I'll pretend the earth is not rotating.) Very gently (that is, *adiabatically*), I carry it down the longitude line passing through Portland, and on beyond, down to the equator. At this stage it is swinging north-south. Now I carry it (still swinging north-south) partway around the equator. And finally, I carry it back up to the North Pole, along the new longitude line. It is clear that the pendulum will no longer be swinging in the same plane as it was when I set out—indeed, the new plane makes an angle Θ with the old one, where Θ is the angle between the southbound and the northbound longitude lines. Now Θ is equal to the *solid angle* (Ω) subtended (at the center of the earth) by the path around which I carried the pendulum. For this path surrounds a fraction $\Theta/2\pi$ of the northern hemisphere, so its area is $A = (1/2)(\Theta/2\pi)4\pi R^2 = \Theta R^2$ (where R is the radius of the earth), and hence

$$\Theta = A/R^2 \equiv \Omega. \tag{10.36}$$

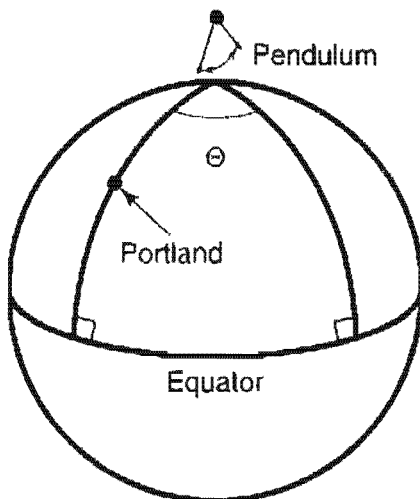

Figure 10.7: Itinerary for adiabatic transport of a pendulum on the surface of the earth.

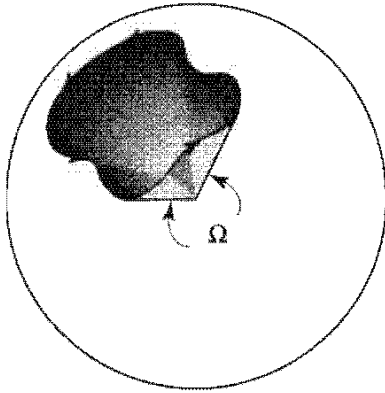

Figure 10.8: Arbitrary path on the surface of a sphere, subtending a solid angle Ω .

This is a particularly nice way to express the answer, because it turns out to be independent of the *shape* of the path (Figure 10.8).⁷

Incidentally, the **Foucault pendulum** is an example of precisely this sort of adiabatic transport around a closed loop on a sphere—only this time instead of *me* carrying the pendulum around, I let the *rotation of the earth* do the job. The solid angle subtended by a latitude line θ_0 (Figure 10.9) is

$$\Omega = \int \sin \theta \, d\theta \, d\phi = 2\pi (-\cos \theta) \Big|_0^{\theta_0} = 2\pi(1 - \cos \theta_0). \quad [10.37]$$

Relative to the earth (which has meanwhile turned through an angle of 2π), the daily precession of the Foucault pendulum is $2\pi \cos \theta_0$ —a result that is ordinarily obtained by appeal to Coriolis forces in the rotating reference frame,⁸ but is seen in this context to admit a purely *geometrical* interpretation.

A system such as this, which does not return to its original state when transported around a closed loop, is said to be **nonholonomic**. (The “transport” in question need not involve physical *motion*: What we have in mind is that the external parameters of

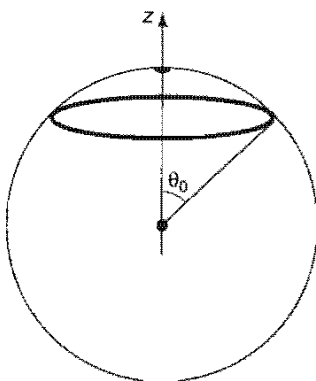

Figure 10.9: Path of a Foucault pendulum in the course of one day.

⁷You can prove this for yourself, if you are interested. Think of the circuit as being made up of tiny segments of great circles (geodesics on the sphere); the pendulum makes a fixed angle with each geodesic segment, so the net angular deviation is related to the sum of the vertex angles of the spherical polygon.

⁸See, for example, Jerry B. Marion, *Classical Dynamics*, 2nd ed. (New York: Academic Press, 1970), Section 11.4. Geographers measure latitude (λ) up from the equator, rather than down from the pole, so $\cos \theta_0 = \sin \lambda$.

the system are changed in some fashion that eventually returns them to their initial values.) Nonholonomic systems are ubiquitous—in a sense, every cyclical engine is a nonholonomic device: At the end of each cycle the car has moved forward a bit, or a weight has been lifted slightly, or something. The idea has even been applied to the locomotion of microbes in fluids at low Reynolds number.⁹ My project for the next section is to study the *quantum mechanics of nonholonomic, adiabatic processes*. The essential question is this: How does the final state differ from the initial state, if the parameters in the Hamiltonian are carried adiabatically around some closed cycle?

10.2.2 Geometric Phase

If the Hamiltonian is *independent* of time, then a particle which starts out in the n th eigenstate $\psi_n(x)$,

$$H\psi_n(x) = E_n\psi_n(x),$$

remains in the n^{th} eigenstate, simply picking up a phase factor:

$$\Psi_n(x, t) = \psi_n(x)e^{-iE_n t/\hbar}, \tag{10.38}$$

If the Hamiltonian *changes* with time, then the eigenfunctions and eigenvalues themselves are time dependent:

$$H(t)\psi_n(x, t) = E_n(t)\psi_n(x, t). \tag{10.39}$$

But the adiabatic theorem tells us that when H changes very *gradually*, a particle which starts out in the n th eigenstate will *remain* in the n^{th} eigenstate—picking up at most a time-dependent phase factor—even as the eigenfunction itself evolves. That is to say,

$$\Psi_n(x, t) = \psi_n(x, t)e^{-\frac{i}{\hbar} \int_0^t E_n(t') dt'} e^{i\gamma_n(t)}. \tag{10.40}$$

The term

$$\theta_n(t) \equiv -\frac{1}{\hbar} \int_0^t E_n(t') dt' \tag{10.41}$$

is known as the **dynamic phase**; it generalizes the “standard” factor $(-E_n t/\hbar)$ to the case where E_n is a function of time. (You will have encountered dynamical phase factors already, if you worked Problems 9.16 and 10.1.) Any “extra” phase, $\gamma_n(t)$, is called the **geometric phase**. At the moment we don't know what it is, or what physical significance (if any) it carries; all we can say is that the adiabatic theorem does not *rule out* such a factor, since the particle is still “in the n^{th} eigenstate”, *whatever* the value of γ_n . [More precisely, a measurement of the energy at time t would be certain to return the value $E_n(t)$.] Indeed, since the eigenvalue equation (Equa-

⁹The pendulum example is an application of **Hannay's angle**, which is the classical analog to Berry's phase. For a collection of papers on both subjects, see Alfred Shapere and Frank Wilczek, eds., *Geometric Phases in Physics*, (Singapore: World Scientific, 1989).

tion 10.39) and the normalization condition only determine $\psi_n(x, t)$ up to an arbitrary phase, and since this arbitrary phase could in principle be chosen independently at each instant of time [though in practice we shall always take $\psi_n(x, t)$ to be a *smooth* function of t], we *have* to allow for an arbitrary phase factor in Equation [10.40].¹⁰ Notice, incidentally, that energy is not conserved here. Of *course* not: Whoever is changing the Hamiltonian is pumping energy into or out of the system.

If we plug Equation 10.40 into the (time-dependent) Schrödinger equation,

$$i\hbar \frac{\partial \Psi}{\partial t} = H(t)\Psi, \quad [10.42]$$

there emerges a simple formula for the time development of the geometric phase:

$$\begin{aligned} i\hbar \left[\frac{\partial \psi_n}{\partial t} e^{i\theta_n} e^{i\gamma_n} - \frac{i}{\hbar} E_n \psi_n e^{i\theta_n} e^{i\gamma_n} + i \frac{d\gamma_n}{dt} \psi_n e^{i\theta_n} e^{i\gamma_n} \right] \\ = [H\psi_n] e^{i\theta_n} e^{i\gamma_n} = E_n \psi_n e^{i\theta_n} e^{i\gamma_n}, \end{aligned}$$

whence

$$\frac{\partial \psi_n}{\partial t} + i \psi_n \frac{d\gamma_n}{dt} = 0. \quad [10.43]$$

Taking the inner product with ψ_n (which I assume has been normalized), we obtain

$$\frac{d\gamma_n}{dt} = i \langle \psi_n | \frac{\partial \psi_n}{\partial t} \rangle. \quad [10.44]$$

Now $\psi_n(x, t)$ depends on t because there is some parameter $R(t)$ in the Hamiltonian that is changing with time. [In Problem 10.1, $R(t)$ would be the width of the infinite square well, whose right wall is expanding.] Thus

$$\frac{\partial \psi_n}{\partial t} = \frac{\partial \psi_n}{\partial R} \frac{dR}{dt}, \quad [10.45]$$

so that

$$\frac{d\gamma_n}{dt} = i \langle \psi_n | \frac{\partial \psi_n}{\partial R} \rangle \frac{dR}{dt},$$

and hence

$$\gamma_n(t) = i \int_0^t \langle \psi_n | \frac{\partial \psi_n}{\partial R} \rangle \frac{dR}{dt'} dt' = i \int_{R_i}^{R_f} \langle \psi_n | \frac{\partial \psi_n}{\partial R} \rangle dR, \quad [10.46]$$

where R_i and R_f are the initial and final values of $R(t)$. In particular, if the Hamiltonian returns to its original form after time T , so that $R_f = R_i$, then $\gamma_n(T) = 0$ —nothing very interesting *there*!

¹⁰For this reason, most people assumed until quite recently that the geometric phase was of no conceivable physical significance. It was Michael Berry's inspiration to realize that if you carry the Hamiltonian around a closed *cycle*, bringing it back to its original form at the end, the relative phase at the beginning and at the end of the process is a *nonarbitrary* quantity, with profound physical implications.

However, I assumed (in Equation 10.45) that there is only *one* parameter in the Hamiltonian that is changing. Suppose there are N of them: $R_1(t)$, $R_2(t)$, \dots , $R_N(t)$; in that case

$$\frac{\partial \psi_n}{\partial t} = \frac{\partial \psi_n}{\partial R_1} \frac{dR_1}{dt} + \frac{\partial \psi_n}{\partial R_2} \frac{dR_2}{dt} + \dots + \frac{\partial \psi_n}{\partial R_N} \frac{dR_N}{dt} = (\nabla_{\mathbf{R}} \psi_n) \cdot \frac{d\mathbf{R}}{dt}, \quad [10.47]$$

where $\mathbf{R} \equiv (R_1, R_2, \dots, R_N)$, and $\nabla_{\mathbf{R}}$ is the gradient with respect to these parameters. This time we have

$$\gamma_n(t) = i \int_{\mathbf{R}_i}^{\mathbf{R}_f} \langle \psi_n | \nabla_{\mathbf{R}} \psi_n \rangle \cdot d\mathbf{R}, \quad [10.48]$$

and if the Hamiltonian returns to its original form after a time T , the net geometric phase change is

$$\gamma_n(T) = i \oint \langle \psi_n | \nabla_{\mathbf{R}} \psi_n \rangle \cdot d\mathbf{R}. \quad [10.49]$$

This is a *line* integral around a closed loop in parameter space, and it is *not*, in general, zero. Equation 10.49 was first obtained by Berry in 1984,¹¹ and $\gamma_n(T)$ is called **Berry's phase**. Notice that $\gamma_n(T)$ depends *only on the path taken*, not on how *fast* that path is traversed (provided, of course, that it is slow enough to validate the adiabatic hypothesis). By contrast, the accumulated *dynamic* phase,

$$\theta_n(T) = -\frac{1}{\hbar} \int_0^T E_n(t') dt',$$

depends critically on the elapsed time.

The derivation of Berry's phase raises several questions, which I would like to address before turning to some examples and applications.

1. **Is $\gamma_n(t)$ real?** If it's *not*, then $e^{i\gamma_n}$ is not a phase factor at all, but an *exponential* factor, and the normalization of Ψ_n (in Equation 10.40) is lost. Since the time-dependent Schrödinger equation conserves probability, it must preserve normalization. It would be comforting to *check* this, by showing explicitly that Equation 10.48 yields a real γ_n . In fact, this is very easy to do. First note that

$$\nabla_{\mathbf{R}} \langle \psi_n | \psi_n \rangle = 0 \quad [10.50]$$

(because by assumption ψ_n is normalized). So

$$\langle \nabla_{\mathbf{R}} \psi_n | \psi_n \rangle + \langle \psi_n | \nabla_{\mathbf{R}} \psi_n \rangle = \langle \psi_n | \nabla_{\mathbf{R}} \psi_n \rangle^* + \langle \psi_n | \nabla_{\mathbf{R}} \psi_n \rangle = 0.$$

Since $\langle \psi_n | \nabla_{\mathbf{R}} \psi_n \rangle$ plus its complex conjugate is zero, it follows that

$$\langle \psi_n | \nabla_{\mathbf{R}} \psi_n \rangle \text{ is imaginary,} \quad [10.51]$$

and hence, by Equation 10.48, $\gamma_n(t)$ is real. [Incidentally, if ψ_n itself is *real*, then so

¹¹M. V. Berry, *Proc. R. Soc. Lond. A* **392**, 45 (1984), reprinted in Shapere and Wilczek, (footnote 9). It is astonishing, in retrospect, that such a fundamental result escaped notice for 60 years.

(obviously) is $\langle \psi_n | \nabla_R \psi_n \rangle$ —this quantity is both real and imaginary, and it must therefore be *zero*. Evidently the geometric phase vanishes whenever the eigenfunctions (of $H(t)$) are real.]

2. Is Berry's phase measurable? We are accustomed to thinking that the phase of the wave function is arbitrary—physical quantities involve $|\Psi|^2$, and the phase factor cancels out. But $\gamma_n(T)$ *can* be measured, if (for example) we take a beam of particles (all in the state Ψ) and split it in two, so that one beam passes through an adiabatically changing potential, while the other does not. When the two beams are recombined, the total wave function has the form

$$\Psi = \frac{1}{2}\Psi_0 + \frac{1}{2}\Psi_0 e^{i\Gamma}, \quad [10.52]$$

where Ψ_0 is the “direct” beam wave function, and Γ is the *extra* phase (in part dynamic, and in part geometric) acquired by the beam subjected to the varying H). In this case

$$\begin{aligned} |\Psi|^2 &= \frac{1}{4}|\Psi_0|^2 (1 + e^{i\Gamma})(1 + e^{-i\Gamma}) \\ &= \frac{1}{2}|\Psi_0|^2 (1 + \cos \Gamma) = |\Psi_0|^2 \cos^2(\Gamma/2). \end{aligned} \quad [10.53]$$

So by looking for points of constructive and destructive interference (where Γ is an even or odd multiple of π , respectively), one can easily measure Γ . (Berry, and other early writers, worried that the geometric phase might be swamped by a larger dynamic phase, but it has proved possible to arrange things so as to separate out the two contributions.)

3. Where does the derivation invoke the adiabatic hypothesis? At first glance, the argument going from Equation 10.40 to Equation 10.48 appears to have proved altogether *too* much. Why doesn't the derivation work *in reverse*, showing that as long as $\gamma_n(t)$ is given by Equation 10.48, the expression in Equation 10.40 satisfies the Schrödinger equation *exactly*—*whether or not the process is adiabatic?*(!) (This would, of course, be nonsense; it would imply that the adiabatic theorem is empty: No transitions *ever* occur, even if the change in the Hamiltonian is far from gradual.) The answer is that the step following Equation 10.43, in which we take the inner product, *cannot* in general be reversed: Although Equation 10.43 implies Equation 10.44, Equation 10.44 does *not* imply Equation 10.43. In fact, there is a serious fraud in the derivation, which I did not confess at the time because it somewhat spoils the beauty of the argument. The truth is that although Equation 10.44 is correct, Equation 10.43 is *not*.¹² For Equation 10.40 is only true in the extreme adiabatic limit—the

¹²Indeed, if you take Equation 10.43 at face value, it can be solved directly for γ_n :

$$\frac{d\gamma_n}{dt} = i \frac{\partial}{\partial t} (\ln \psi_n) \Rightarrow \psi_n(x, t) = \phi_n(x) e^{-i\gamma_n(t)},$$

and hence (going back to Equation 10.40),

$$\Psi_n(x, t) = \phi_n(x) e^{-\frac{i}{\hbar} \int_0^t E_n(t') dt'}.$$

The geometric phase, in effect, *soaks up* the time dependence acquired by the eigenfunction $\psi_n(x, t)$ as a consequence of the change in H . But this is completely false, as we shall see in the examples.

exact solution would contain admixtures of other states:

$$\Psi_n(x, t) = \psi_n(x, t)e^{i\theta_n(t)}e^{i\gamma_n(t)} + \epsilon \sum_{m \neq n} c_m(t)\psi_m(x, t), \quad [10.54]$$

where $\epsilon \equiv T_i/T_e$ characterizes the departure from adiabaticity (it goes to zero in the adiabatic limit). Inclusion of this term modifies Equation 10.43, to read

$$\frac{\partial \psi_n}{\partial t} + i\psi_n \frac{d\gamma_n}{dt} = -e^{-i\theta_n}e^{-i\gamma_n} \epsilon \sum_{m \neq n} \left[\left(\frac{i}{\hbar} c_m E_m + \frac{dc_m}{dt} \right) \psi_m + c_m \frac{\partial \psi_m}{\partial t} \right]. \quad [10.55]$$

Both terms on the left are first order in ϵ (if the Hamiltonian didn't change at *all*, both $\partial \psi_n/\partial t$ and γ_n would be zero), but *so are the first two terms on the right*. The *final* term is *second* order, so it can legitimately be ignored, but dropping the first two (as I did, implicitly, in my derivation of Equation 10.43), is illegal. For consistency (noting, while I'm at it, that γ_n is already first order, so $e^{i\gamma_n} \cong 1$ on the right), I *should* have written

$$\frac{\partial \psi_n}{\partial t} + i\psi_n \frac{d\gamma_n}{dt} = -e^{-i\theta_n} \epsilon \sum_{m \neq n} \left(\frac{i}{\hbar} c_m E_m + \frac{dc_m}{dt} \right) \psi_m, \quad [10.56]$$

instead of Equation 10.43. Fortunately, the inner product (with ψ_n) kills the extra term, and that's how it comes about that Equation 10.44 is correct, even though Equation 10.43, from which it was obtained, was *not*. (See Problem 10.7.)

When the parameter space is three dimensional, $\mathbf{R} = (R_1, R_2, R_3)$, Berry's formula (Equation 10.49) is reminiscent of the expression for **magnetic flux** in terms of the vector potential \mathbf{A} . The flux, Φ , through a surface S bounded by a curve C (Figure 10.10), is

$$\Phi \equiv \int_S \mathbf{B} \cdot d\mathbf{a}. \quad [10.57]$$

If we write the magnetic field in terms of the vector potential ($\mathbf{B} = \nabla \times \mathbf{A}$), and apply Stokes' theorem:

$$\Phi = \int_S (\nabla \times \mathbf{A}) \cdot d\mathbf{a} = \oint_C \mathbf{A} \cdot d\mathbf{r}. \quad [10.58]$$

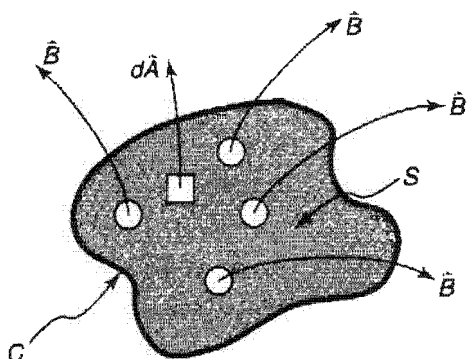

Figure 10.10: Magnetic flux through a surface S bounded by the closed curve C .

Thus Berry's phase can be thought of as the "flux" of a "magnetic field"

$$\mathbf{B} = i \nabla_R \times \langle \psi_n | \nabla_R \psi_n \rangle, \quad [10.59]$$

through the (closed-loop) trajectory in parameter space. In the three-dimensional case, then, Berry's phase can be written as a surface integral,

$$\gamma_n(T) = i \int [\nabla_R \times \langle \psi_n | \nabla_R \psi_n \rangle] \cdot d\mathbf{a}. \quad [10.60]$$

The magnetic analogy can be carried much further, but for our purposes Equation 10.60 is merely a convenient alternative expression for $\gamma_n(T)$.

*Problem 10.4

- (a) Use Equation 10.46 to calculate the geometric phase change when the infinite square well expands adiabatically from width w_1 to width w_2 . Comment on this result.
- (b) If the expansion occurs at a constant rate ($dw/dt = v$), what is the dynamic phase change for this process?
- (c) If the well now contracts back to its original size, what is Berry's phase for the cycle?

Problem 10.5 The delta-function well (Equation 2.96) supports a single bound state (Equation 2.111). Calculate the geometric phase change when α gradually increases from α_1 to α_2 . If the increase occurs at a constant rate ($d\alpha/dt = c$), what is the dynamic phase change for this process?

Problem 10.6 As I noted in the text (and Problems 10.4 and 10.5 confirm), if $\psi_n(x, t)$ is *real*, the geometric phase vanishes. You might try to beat this rap by tacking an unnecessary (but perfectly legal) phase factor onto the eigenfunctions: $\psi'_n(x, t) \equiv e^{i\phi_n} \psi_n(x, t)$, where $\phi_n(\mathbf{R})$ is an arbitrary (real) function. Try it. You'll get a nonzero geometric phase, all right, but note what happens when you put it back into Equation 10.40. And for a closed loop it gives *zero*. *Moral*: For nonzero Berry's phase, you need (1) more than one time-dependent parameter in the Hamiltonian, and (2) a Hamiltonian that yields nontrivially complex eigenfunctions.

10.2.3 An Example

The classic example of Berry's phase is an electron at the origin, subjected to a magnetic field of constant magnitude but changing direction. Consider first the special case (analyzed in Section 10.1.3) in which $\mathbf{B}(t)$ precesses around at a constant angular

velocity ω , making a fixed angle α with the z -axis. The *exact* solution (for an electron that starts out with “spin up” along \mathbf{B}) is given by Equation 10.33. In the adiabatic regime, $\omega \ll \omega_1$,

$$\lambda = \omega_1 \sqrt{1 + 2 \frac{\omega}{\omega_1} \cos \alpha + \left(\frac{\omega}{\omega_1}\right)^2} \cong \omega_1 \left(1 + \frac{\omega}{\omega_1} \cos \alpha\right) = \omega_1 + \omega \cos \alpha, \quad [10.61]$$

and Equation 10.33 becomes

$$\begin{aligned} \chi(t) &\cong e^{i\omega_1 t/2} e^{i(\omega \cos \alpha)t/2} e^{-i\omega t/2} \chi_+(t) \\ &+ i \left[\frac{\omega}{\omega_1} \sin \alpha \sin \left(\frac{\omega_1 t}{2}\right) \right] e^{-i\omega t/2} \chi_-(t). \end{aligned} \quad [10.62]$$

As $\omega/\omega_1 \rightarrow 0$ the second term drops out completely, and the result matches the expected adiabatic form (Equation 10.40). The dynamic phase is

$$\theta_+(t) = -\frac{1}{\hbar} \int_0^t E_+(t') dt' = \frac{\omega_1 t}{2} \quad [10.63]$$

(where $E_+ = -\hbar\omega_1/2$ is taken from Equation 10.29), so the geometric phase is

$$\gamma_+(t) = (\cos \alpha - 1) \frac{\omega t}{2}. \quad [10.64]$$

For a complete cycle $T = 2\pi/\omega$, and therefore Berry's phase is

$$\gamma_+(T) = \pi(\cos \alpha - 1). \quad [10.65]$$

Now consider the more general case, in which the tip of the magnetic field vector sweeps out an *arbitrary* closed curve on the surface of a sphere of radius $r = B_0$ (Figure 10.11). The eigenstate representing spin up along $\mathbf{B}(t)$ has the form (see Problem 4.31)

$$\chi_+ = \begin{pmatrix} \cos(\theta/2) \\ e^{i\phi} \sin(\theta/2) \end{pmatrix}, \quad [10.66]$$

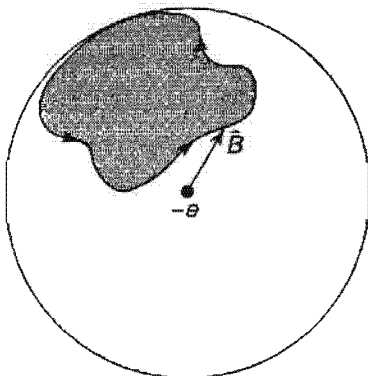

Figure 10.11: Magnetic field of constant magnitude but changing direction sweeps out a closed loop.

where θ and ϕ (the spherical coordinates of \mathbf{B}) are now *both* functions of time. Looking up the gradient in spherical coordinates, we find

$$\begin{aligned}\nabla\chi_+ &= \frac{\partial\chi_+}{\partial r}\hat{r} + \frac{1}{r}\frac{\partial\chi_+}{\partial\theta}\hat{\theta} + \frac{1}{r\sin\theta}\frac{\partial\chi_+}{\partial\phi}\hat{\phi} \\ &= \frac{1}{r}\begin{pmatrix} -(1/2)\sin(\theta/2) \\ (1/2)e^{i\phi}\cos(\theta/2) \end{pmatrix}\hat{\theta} + \frac{1}{r\sin\theta}\begin{pmatrix} 0 \\ ie^{i\phi}\sin(\theta/2) \end{pmatrix}\hat{\phi}.\end{aligned}\quad [10.67]$$

Hence

$$\begin{aligned}\langle\chi_+|\nabla\chi_+\rangle &= \frac{1}{2r}\left[-\sin(\theta/2)\cos(\theta/2)\hat{\theta} + \sin(\theta/2)\cos(\theta/2)\hat{\theta}\right. \\ &\quad \left.+ 2i\frac{\sin^2(\theta/2)}{\sin\theta}\hat{\phi}\right] = i\frac{\sin^2(\theta/2)}{r\sin\theta}\hat{\phi}.\end{aligned}\quad [10.68]$$

For Equation 10.60 we need the *curl* of this quantity:

$$\nabla\times\langle\chi_+|\nabla\chi_+\rangle = \frac{1}{r\sin\theta}\frac{\partial}{\partial\theta}\left[\sin\theta\left(\frac{ie^{i\phi}\sin^2(\theta/2)}{r\sin\theta}\right)\right]\hat{r} = \frac{i}{2r^2}\hat{r}.\quad [10.69]$$

According to Equation 10.60, then,

$$\gamma_+(T) = -\frac{1}{2}\int\frac{1}{r^2}\hat{r}\cdot d\mathbf{a}.\quad [10.70]$$

The integral is over the area on the sphere swept out by \mathbf{B} in the course of the cycle, so $d\mathbf{a} = r^2 d\Omega \hat{r}$, and hence

$$\gamma_+(T) = -\frac{1}{2}\int d\Omega = -\frac{1}{2}\Omega,\quad [10.71]$$

where Ω is the solid angle subtended at the origin. This is a delightfully simple result, and tantalizingly reminiscent of the classical problem with which we began the discussion (transport of a frictionless pendulum around a closed path on the surface of the earth). It says that if you take a magnet, and lead the electron's spin around adiabatically in an arbitrary closed path, the net (geometric) phase change will be minus one half the solid angle swept out by the magnetic field vector. In view of Equation 10.37, the general result is consistent with the special case Equation 10.65, as of course it *had* to be.

Problem 10.7 Consider, once again, the special case of the precessing field (Section 10.1.3).

- (a) Use the eigenspinor (Equation 10.27) to determine $\langle\chi_+|(\partial\chi_+/\partial t)\rangle$, and put the result into Equation 10.44, for an alternative derivation of Equation 10.64.

- (b) Show that Equation 10.43 does *not* work, in this case. Use Equation 10.62 to determine c_- (in Equation 10.54). Confirm that the last term in Equation 10.55 is second order in ω (don't forget the $\epsilon = \omega/\omega_1$ out front). Show that $\gamma_+(t)$ (Equation 10.64) does satisfy the *corrected* version of Equation 10.43, Equation 10.56.

*****Problem 10.8** Work out the analog to Equation 10.71 for a particle of spin 1. *Answer:* $-\Omega$ (for spin s the result is $-s\Omega/2$).

10.2.4 The Aharonov-Bohm Effect

In classical electrodynamics the potentials (φ and \mathbf{A})¹³ are not directly measurable—the physical quantities are the electric and magnetic fields:

$$\mathbf{E} = -\nabla\varphi - \frac{\partial\mathbf{A}}{\partial t}, \quad \mathbf{B} = \nabla \times \mathbf{A}. \quad [10.72]$$

The fundamental laws of the theory (Maxwell's equations and the Lorentz force law) make no reference to potentials, which are (from a logical point of view) no more than convenient but dispensable scaffolding for getting a better purchase on the real structure (the fields). Indeed, you're perfectly free to *change* the potentials:

$$\varphi \rightarrow \varphi' = \varphi - \frac{\partial\Lambda}{\partial t}, \quad \mathbf{A} \rightarrow \mathbf{A}' = \mathbf{A} + \nabla\Lambda, \quad [10.73]$$

where Λ is an arbitrary function of position and time; this is called a gauge transformation, and it has no effect at all on the fields.

In quantum mechanics the potentials play a more significant role, for the Hamiltonian (Equation 4.201) is expressed in terms of φ and \mathbf{A} , not \mathbf{E} and \mathbf{B} :

$$H = \frac{1}{2m} \left(\frac{\hbar}{i} \nabla - q\mathbf{A} \right)^2 + q\varphi. \quad [10.74]$$

Nevertheless, the theory is still invariant under gauge transformations (see Problem 4.53), and it was taken for granted until quite recently that there could be no electromagnetic influences in regions where \mathbf{E} and \mathbf{B} are zero—any more than there can be in the classical theory. But in 1959 Aharonov and Bohm¹⁴ showed that the vector potential *can* affect the quantum behavior of a charged particle that never encounters an electromagnetic field. I'll work out a simple example first, then discuss the

¹³I'm sorry, but we have reached a notational impasse: It is customary in quantum mechanics to use the letter V for *potential energy*, but in electrodynamics the same letter is reserved for the scalar potential. To avoid confusion I'll use φ for the scalar potential. See Problems 4.51, 4.52, and 4.53 for background on this material.

¹⁴Y. Aharonov and D. Bohm, *Phys. Rev.* **115**, 485 (1959). For a significant precursor, see W. Ehrenberg and R. E. Siday, *Proc. Phys. Soc. London* **B62**, 8 (1949).

Aharonov-Bohm effect itself, and finally indicate how it can be thought of as an example of Berry's phase.

Imagine a particle constrained to move in a circle of radius b (a bead on a wire ring, if you like). Along the axis runs a solenoid of radius $a < b$, carrying a magnetic field \mathbf{B} (see Figure 10.12). If the solenoid is extremely long, the field inside is uniform, and the field outside is zero. But the vector potential outside the solenoid is *not* zero; in fact (adopting the convenient gauge condition $\nabla \cdot \mathbf{A} = 0$),¹⁵

$$\mathbf{A} = \frac{\Phi}{2\pi r} \hat{\phi}, \quad (r > a), \quad [10.75]$$

where $\Phi = \pi a^2 B$ is the **magnetic flux** through the solenoid. Meanwhile, the solenoid is uncharged, so the scalar potential φ is zero. In this case the Hamiltonian (Equation 10.74) becomes

$$H = \frac{1}{2m} [-\hbar^2 \nabla^2 + q^2 A^2 + 2i\hbar q \mathbf{A} \cdot \nabla]. \quad [10.76]$$

But the wave function depends only on the azimuthal angle ϕ , ($\theta = \pi/2$ and $r = b$) so $\nabla \rightarrow (\hat{\phi}/b)(d/d\phi)$, and the Schrödinger equation reads

$$\frac{1}{2m} \left[-\frac{\hbar^2}{b^2} \frac{d^2}{d\phi^2} + \left(\frac{q\Phi}{2\pi b} \right)^2 + i \frac{\hbar q \Phi}{\pi b^2} \frac{d}{d\phi} \right] \psi(\phi) = E\psi(\phi). \quad [10.77]$$

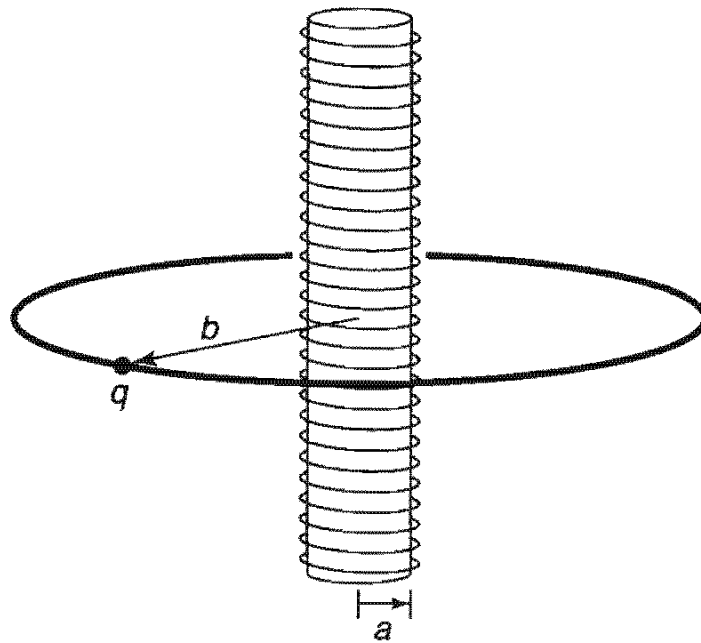

Figure 10.12: Charged bead on a circular ring through which a long solenoid passes.

This is a linear differential equation with constant coefficients:

$$\frac{d^2\psi}{d\phi^2} - 2i\beta \frac{d\psi}{d\phi} + \epsilon\psi = 0, \quad [10.78]$$

¹⁵See, for instance, D. J. Griffiths, *Introduction to Electrodynamics*, 2nd ed. (Englewood Cliffs, NJ: Prentice Hall, 1989), Equation 5.65.

where

$$\beta \equiv \frac{q\Phi}{2\pi\hbar} \quad \text{and} \quad \epsilon \equiv \frac{2mb^2E}{\hbar^2} - \beta^2. \quad [10.79]$$

Solutions are of the form

$$\psi = Ae^{i\lambda\phi}, \quad [10.80]$$

with

$$\lambda = \beta \pm \sqrt{\beta^2 + \epsilon} = \beta \pm \frac{b}{\hbar} \sqrt{2mE}. \quad [10.81]$$

Continuity of $\psi(\phi)$, at $\phi = 2\pi$, requires that λ be an *integer*:

$$\beta \pm \frac{b}{\hbar} \sqrt{2mE} = n, \quad [10.82]$$

and it follows that

$$E_n = \frac{\hbar^2}{2mb^2} \left(n - \frac{q\Phi}{2\pi\hbar} \right)^2, \quad (n = 0, \pm 1, \pm 2, \dots). \quad [10.83]$$

The solenoid lifts the twofold degeneracy of the bead on a ring (Problem 2.43): Positive n , representing a particle traveling in the *same* direction as the current in the solenoid, has a somewhat *lower* energy (assuming q is positive) than negative n , describing a particle traveling in the *opposite* direction. And, more important, the allowed energies clearly depend on the field inside the solenoid, *even though the field at the location of the particle is zero*.¹⁶

More generally, suppose a particle is moving through a region where \mathbf{B} is zero (so $\nabla \times \mathbf{A} = 0$), but \mathbf{A} itself is *not*. (I'll assume that \mathbf{A} is static, although the method can be generalized to time-dependent potentials.) The (time-dependent) Schrödinger equation,

$$\left[\frac{1}{2m} \left(\frac{\hbar}{i} \nabla - q\mathbf{A} \right)^2 + V \right] \Psi = i\hbar \frac{\partial \Psi}{\partial t}, \quad [10.84]$$

with potential energy V —which may or may not include an electrical contribution $q\varphi$ —can be simplified by writing

$$\Psi = e^{ig}\Psi', \quad [10.85]$$

where

$$\mathbf{g}(\mathbf{r}) \equiv \frac{q}{\hbar} \int_{\mathcal{O}}^{\mathbf{r}} \mathbf{A}(\mathbf{r}') \cdot d\mathbf{r}', \quad [10.86]$$

¹⁶It is a peculiar property of **superconducting** rings that the enclosed flux is *quantized*: $\Phi = (2\pi\hbar/q)n'$, where n' is an integer. In this case the effect is undetectable, since $E_n = (\hbar^2/2mb^2)(n + n')^2$, and $(n + n')$ is just another integer. (Incidentally, the charge q here turns out to be *twice* the charge of an electron; the superconducting electrons are locked together in pairs.) However, **flux quantization** is enforced by the *superconductor* (which induces circulating currents to make up the difference), not by the solenoid or the electromagnetic field, and it does not occur in the example considered here.

and \mathcal{O} is some (arbitrarily chosen) reference point. Note that this definition makes sense *only* when $\nabla \times \mathbf{A} = 0$ throughout the region in question—otherwise the line integral depends entirely on the *path* taken from \mathcal{O} to \mathbf{r} , and hence does not define a function of \mathbf{r} . In terms of Ψ' , the gradient of Ψ is

$$\nabla\Psi = e^{ig}(i\nabla g)\Psi' + e^{ig}(\nabla\Psi');$$

but $\nabla g = (q/\hbar)\mathbf{A}$, so

$$\left(\frac{\hbar}{i}\nabla - q\mathbf{A}\right)\Psi = \frac{\hbar}{i}e^{ig}\nabla\Psi', \quad [10.87]$$

and it follows that

$$\left(\frac{\hbar}{i}\nabla - q\mathbf{A}\right)^2\Psi = -\hbar^2e^{ig}\nabla^2\Psi'. \quad [10.88]$$

Putting this into Equation 10.84, and canceling the common factor of e^{ig} , we are left with

$$-\frac{\hbar^2}{2m}\nabla^2\Psi' + V\Psi' = i\hbar\frac{\partial\Psi'}{\partial t}. \quad [10.89]$$

Evidently Ψ' satisfies the Schrödinger equation *without* \mathbf{A} . If we can solve Equation 10.89, correcting for the presence of a (curl-free) vector potential is trivial: You just tack on the phase factor e^{ig} .

Aharonov and Bohm proposed an experiment in which a beam of electrons is split in two, and passed either side of a long solenoid, before being recombined (Figure 10.13). The beams are kept well away from the solenoid itself, so they encounter only regions where $\mathbf{B} = 0$. But \mathbf{A} , which is given by Equation 10.75, is *not* zero, and (assuming V is the same on both sides), the two beams arrive with *different phases*:

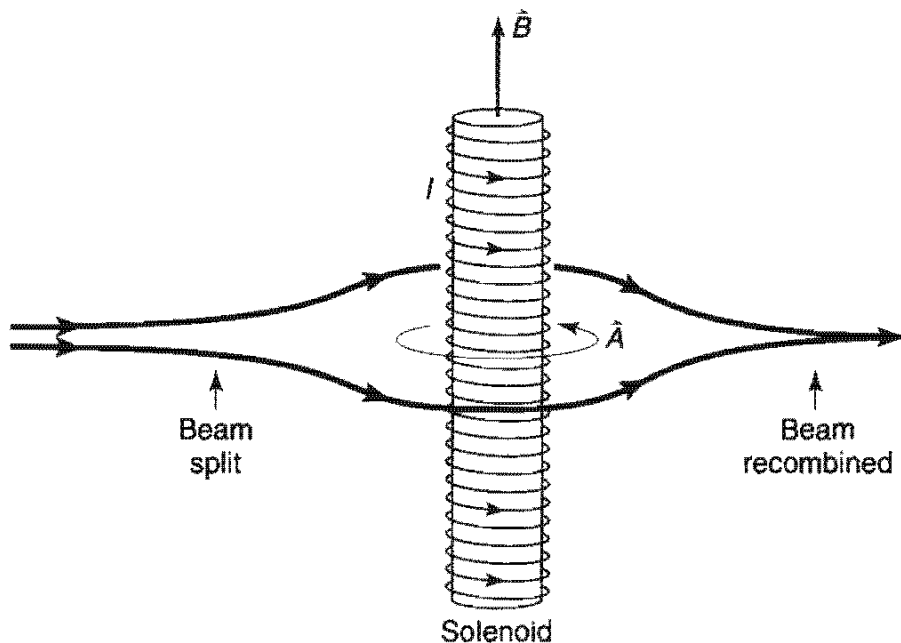

Figure 10.13: The Aharonov-Bohm effect: electron beam splits, with half passing either side of a long solenoid.

$$g = \frac{q}{\hbar} \int \mathbf{A} \cdot d\mathbf{r} = \frac{q\Phi}{2\pi\hbar} \int \left(\frac{1}{r} \hat{\phi} \right) \cdot (r\hat{\phi} d\phi) = \pm \frac{q\Phi}{2\hbar}. \quad [10.90]$$

The plus sign applies to the electrons traveling in the same direction as \mathbf{A} —which is to say, in the same direction as the current in the solenoid. The beams arrive *out of phase* by an amount proportional to the magnetic flux their paths encircle:

$$\text{phase difference} = \frac{q\Phi}{\hbar}. \quad [10.91]$$

This phase shift leads to measurable interference (as in Equation 10.53), and has been confirmed experimentally by Chambers and others.¹⁷

The Aharonov-Bohm effect can be regarded as an example of geometric phase, as Berry himself noted in his first paper. Suppose the charged particle is confined to a box (which is centered at point \mathbf{R} outside the solenoid) by a potential $V(\mathbf{r} - \mathbf{R})$ —see Figure 10.14. (In a moment we're going to transport the box around the solenoid, so \mathbf{R} will become a function of time, but for now it is just some fixed vector.) The eigenfunctions of the Hamiltonian are determined by

$$\left\{ \frac{1}{2m} \left[\frac{\hbar}{i} \nabla - q\mathbf{A}(\mathbf{r}) \right]^2 + V(\mathbf{r} - \mathbf{R}) \right\} \psi_n = E_n \psi_n. \quad [10.92]$$

We have already learned how to solve equations of this form:

$$\psi_n = e^{ig} \psi'_n, \quad [10.93]$$

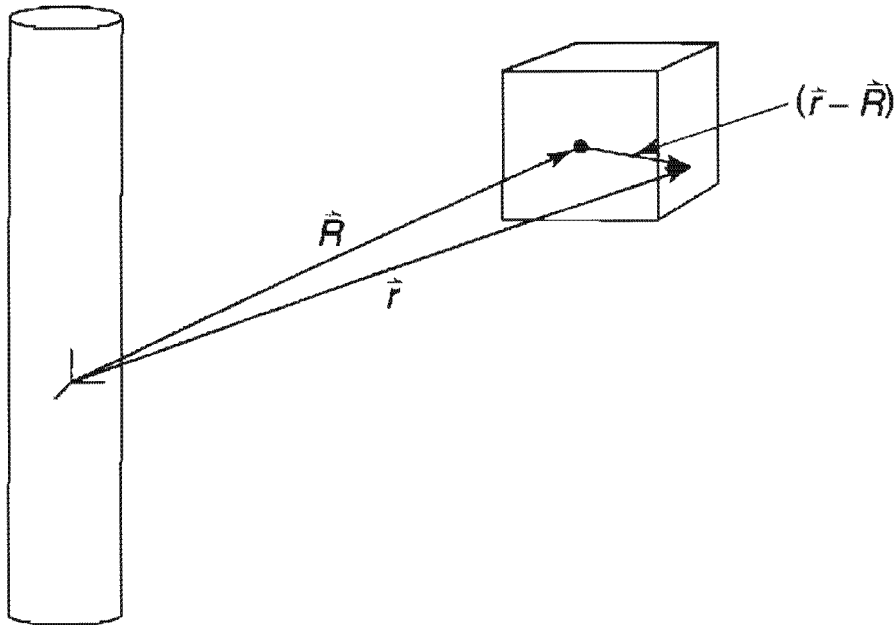

Figure 10.14: Particle confined to a box, by a potential $V(\mathbf{r} - \mathbf{R})$.

¹⁷R. G. Chambers, *Phys. Rev. Lett.* 5, 3 (1960).

where¹⁸

$$g \equiv \frac{q}{\hbar} \int_{\mathbf{R}}^{\mathbf{r}} \mathbf{A}(\mathbf{r}') \cdot d\mathbf{r}' \quad [10.94]$$

and ψ' satisfies the same eigenvalue equation, only with $\mathbf{A} \rightarrow 0$:

$$\left[-\frac{\hbar^2}{2m} \nabla^2 + V(\mathbf{r} - \mathbf{R}) \right] \psi'_n = E_n \psi'_n. \quad [10.95]$$

Notice that ψ'_n is a function only of the combination $(\mathbf{r} - \mathbf{R})$, not (like ψ_n) of \mathbf{r} and \mathbf{R} separately.

Now let's carry the box around the solenoid (in this case the process doesn't even have to be adiabatic). To determine Berry's phase, we must first evaluate the quantity $\langle \psi_n | \nabla_R \psi_n \rangle$. Noting that

$$\nabla_R \psi_n = \nabla_R [e^{ig} \psi'_n(\mathbf{r} - \mathbf{R})] = -i \frac{q}{\hbar} \mathbf{A}(\mathbf{R}) e^{ig} \psi'_n(\mathbf{r} - \mathbf{R}) + e^{ig} \nabla_R \psi'_n(\mathbf{r} - \mathbf{R}),$$

we find

$$\begin{aligned} & \langle \psi_n | \nabla_R \psi_n \rangle \\ &= \int e^{-ig} [\psi'_n(\mathbf{r} - \mathbf{R})]^* e^{ig} \left[-i \frac{q}{\hbar} \mathbf{A}(\mathbf{R}) \psi'_n(\mathbf{r} - \mathbf{R}) + \nabla_R \psi'_n(\mathbf{r} - \mathbf{R}) \right] d^3\mathbf{r} \\ &= -i \frac{q}{\hbar} \mathbf{A}(\mathbf{R}) - \int [\psi'_n(\mathbf{r} - \mathbf{R})]^* \nabla \psi'_n(\mathbf{r} - \mathbf{R}) d^3\mathbf{r}. \end{aligned} \quad [10.96]$$

The ∇ with no subscript denotes the gradient with respect to \mathbf{r} , and I used the fact that $\nabla_R = -\nabla$, when acting on a function of $(\mathbf{r} - \mathbf{R})$. But the last integral is i/\hbar times the expectation value of momentum, in an eigenstate of the Hamiltonian $-(\hbar^2/2m)\nabla^2 + V$, which we know from Section 2.1 is *zero*. So

$$\langle \psi_n | \nabla_R \psi_n \rangle = -i \frac{q}{\hbar} \mathbf{A}(\mathbf{R}). \quad [10.97]$$

Putting this into Berry's formula (Equation 10.49), we conclude that

$$\gamma_n(T) = \frac{q}{\hbar} \oint \mathbf{A}(\mathbf{R}) \cdot d\mathbf{R} = \frac{q}{\hbar} \int (\nabla \times \mathbf{A}) \cdot d\mathbf{a} = \frac{q\Phi}{\hbar}, \quad [10.98]$$

which neatly confirms the Aharonov-Bohm result (Equation 10.91), and reveals that the Aharonov-Bohm effect is a particular instance of geometric phase.¹⁹

¹⁸It is convenient to set the reference point \mathcal{O} at the center of the box, for this guarantees that we recover the original phase convention for ψ_n when we complete the journey around the solenoid. If you use a fixed point in space, for example, you'll have to readjust the phase "by hand", at the far end; this leads to exactly the same answer, but it's a crude way to do it. In general, when choosing the phase convention for the eigenfunctions in Equation 10.39, you want to make sure that $\psi_n(x, T) = \psi_n(x, 0)$ so that no spurious phase changes are introduced.

¹⁹Incidentally, in this case the analogy between Berry's phase and magnetic flux (Equation 10.59) becomes *almost* an identity: " \mathbf{B} " = $(q/\hbar)\mathbf{B}$.

What are we to make of the Aharonov-Bohm effect? Evidently our classical preconceptions are simply *mistaken*: There *can* be electromagnetic effects in regions where the fields are zero. Note, however, that this does not make \mathbf{A} itself measurable—only the enclosed *flux* comes into the final answer, and the theory remains gauge invariant.

Problem 10.9

- (a) Derive Equation 10.76, from Equation 10.74.
 (b) Derive Equation 10.88, starting with Equation 10.87.
-

FURTHER PROBLEMS FOR CHAPTER 10

*****Problem 10.10** Suppose the one-dimensional harmonic oscillator (mass m , frequency ω) is subjected to a driving force of the form $F(t) = m\omega^2 f(t)$, where $f(t)$ is some specified function [I have factored out $m\omega^2$ for notational convenience; notice that $f(t)$ has the dimensions of *length*]. The Hamiltonian is

$$H(t) = -\frac{\hbar^2}{2m} \frac{\partial^2}{\partial x^2} + \frac{1}{2}m\omega^2 x^2 - m\omega^2 x f(t). \quad [10.99]$$

Assume that the force was first turned on at time $t = 0$: $f(t) = 0$ for $t \leq 0$. This system can be solved exactly, both in classical mechanics and in quantum mechanics.²⁰

- (a) Determine the *classical* position of the oscillator, assuming it started out at rest at the origin [$x_c(0) = \dot{x}_c(0) = 0$]. *Answer:*

$$x_c(t) = \omega \int_0^t f(t') \sin[\omega(t - t')] dt'. \quad [10.100]$$

- (b) Show that the solution to the (time-dependent) Schrödinger equation for this oscillator, assuming it started out in the n th state of the *undriven* oscillator [$\Psi(x, 0) = \psi_n(x)$, where $\psi_n(x)$ is given by Equation 2.50], can be written as

$$\Psi(x, t) = \psi_n(x - x_c) e^{\frac{i}{\hbar} \left[-(n + \frac{1}{2})\hbar\omega t + m\dot{x}_c(x - \frac{x_c}{2}) + \frac{m\omega^2}{2} \int_0^t f(t') x_c(t') dt' \right]}. \quad [10.101]$$

- (c) Show that the eigenfunctions and eigenvalues of $H(t)$ are

$$\psi_n(x, t) = \psi_n(x - f); \quad E_n(t) = \left(n + \frac{1}{2} \right) \hbar\omega - \frac{1}{2} m\omega^2 f^2. \quad [10.102]$$

²⁰See Y. Nogami, *Am. J. Phys.* **59**, 64 (1991) and references therein.

- (d) Show that in the adiabatic approximation the classical position (Equation 10.100) reduces to $x_c(t) \cong f(t)$. *Hint:* Use the integration-by-parts trick of Section 10.1.2. State the precise criterion—analogue to Equation 10.15—for adiabaticity.
- (e) Confirm the adiabatic theorem for this example, by using the results in (c) and (d) to show that

$$\Psi(x, t) \cong \psi_n(x, t)e^{i\theta_n(t)}e^{i\gamma_n(t)}. \quad [10.103]$$

Check that the dynamic phase has the correct form (Equation 10.41). Is the geometric phase what you would expect?

*****Problem 10.11** In time-dependent perturbation theory, we used the completeness of the unperturbed eigenfunctions (of H_0) to expand $\Psi(x, t)$ (see Equation 9.81). But we could as well use the instantaneous eigenfunctions of $H(t)$ (Equation 10.39), since they, too, are complete:

$$\Psi(x, t) = \sum_n c_n(t)\psi_n(x, t)e^{i\theta_n}, \quad [10.104]$$

where $\theta_n(t)$ is given by Equation 10.41. We can use this expansion to develop an **adiabatic series**, whose leading term is the adiabatic approximation itself and whose successive terms represent the *departure* from perfect adiabaticity.

- (a) Insert Equation 10.104 into the (time-dependent) Schrödinger equation, and obtain the following formula for the coefficients:

$$\dot{c}_m = - \sum_n \langle \psi_m | \frac{\partial \psi_n}{\partial t} \rangle c_n e^{i(\theta_n - \theta_m)}. \quad [10.105]$$

- (b) Suppose the system starts out in the N^{th} state; in the adiabatic approximation, it *remains* in the N^{th} state, picking up (at most) a time-dependent geometric phase (compare Equations 10.40 and 10.104):

$$c_n(t) = \delta_{nN}e^{i\gamma_N(t)}. \quad [10.106]$$

Substitute this into the right side of Equation 10.105, and obtain the “first correction” to adiabaticity:

$$c_m(t) = c_m(0) - \int_0^t \langle \psi_m | \frac{\partial \psi_N}{\partial t'} \rangle e^{i\gamma_N} e^{i(\theta_N - \theta_m)} dt'. \quad [10.107]$$

This enables us to calculate transition probabilities in the *nearly* adiabatic regime. To develop the “second correction,” we would insert Equation 10.107 on the right side of Equation 10.105, and so on.

- (c) As an example, apply Equation 10.107 to the driven-oscillator (Problem 10.10). Show that (in the near-adiabatic approximation) transitions are possible only to the two immediately adjacent levels, for which

$$c_{N+1}(t) = i \sqrt{\frac{m\omega}{2\hbar}} \sqrt{N+1} \int_0^t \dot{f}(t') e^{i\omega t'} dt',$$

$$c_{N-1}(t) = i \sqrt{\frac{m\omega}{2\hbar}} \sqrt{N} \int_0^t \dot{f}(t') e^{-i\omega t'} dt'.$$

(The transition *probabilities* are the absolute squares of these, of course.)

CHAPTER 11

SCATTERING

11.1 INTRODUCTION

11.1.1 Classical Scattering Theory

Imagine a particle incident on some scattering center (say, a proton fired at a heavy nucleus). It comes in with an energy E and an **impact parameter** b , and it emerges at some **scattering angle** θ —see Figure 11.1. (I'll assume for simplicity that the target is azimuthally symmetrical, so the trajectory remains in one plane, and that the target is very heavy, so the recoil is negligible.) The essential problem of classical scattering

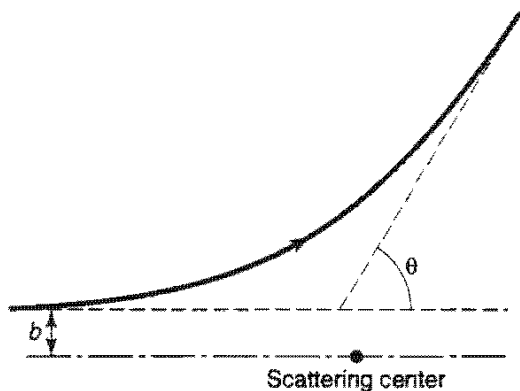

Figure 11.1 The classical scattering problem, showing the impact parameter b and the scattering angle θ .

theory is this: *Given the impact parameter, calculate the scattering angle.* Ordinarily, of course, the smaller the impact parameter, the greater the scattering angle.

Example: Hard-sphere scattering. Suppose the target is a billiard ball, of radius R , and the incident particle is a BB, which bounces off elastically (Figure 11.2). In terms of the angle α , the impact parameter is $b = R \sin \alpha$, and the scattering angle is $\theta = \pi - 2\alpha$, so

$$b = R \sin \left(\frac{\pi}{2} - \frac{\theta}{2} \right) = R \cos \left(\frac{\theta}{2} \right). \quad [11.1]$$

Evidently

$$\theta = \begin{cases} 2 \cos^{-1}(b/R), & \text{if } b \leq R, \\ 0, & \text{if } b \geq R. \end{cases} \quad [11.2]$$

More generally, particles incident within an infinitesimal patch of cross-sectional area $d\sigma$ will scatter into a corresponding infinitesimal solid angle $d\Omega$ (Figure 11.3). The larger $d\sigma$ is, the bigger $d\Omega$ will be; the proportionality factor, $D(\theta) \equiv d\sigma/d\Omega$, is called the **differential (scattering) cross-section**¹:

$d\sigma = D(\theta) d\Omega.$

[11.3]

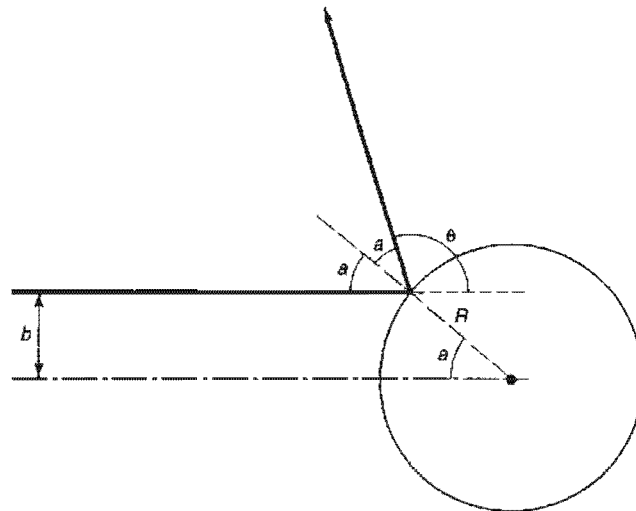

Figure 11.2: Elastic hard-sphere scattering.

¹This is terrible language: D isn't a *differential*—if anything, it's a *derivative*—and it isn't a cross-section. To my ear, the words "differential cross-section" would apply more properly to $d\sigma$. But I'm afraid we're stuck with this terminology. I should also warn you that the notation $D(\theta)$ is nonstandard: Most people just call it $d\sigma/d\Omega$, but I think it will be less confusing if we give the differential cross-section its own symbol.

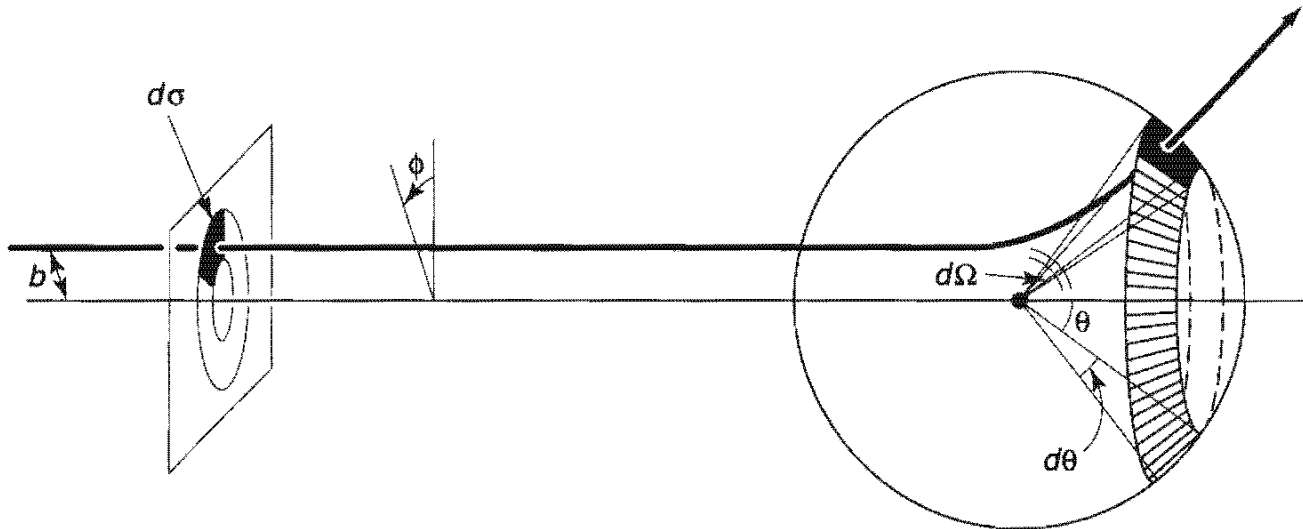

Figure 11.3: Particles incident in the area $d\sigma$ scatter into the solid angle $d\Omega$.

In terms of the impact parameter and the azimuthal angle ϕ , $d\sigma = b db d\phi$ and $d\Omega = \sin\theta d\theta d\phi$, so

$$D(\theta) = \frac{b}{\sin\theta} \left| \frac{db}{d\theta} \right|. \quad [11.4]$$

(Since θ is typically a *decreasing* function of b , the derivative is actually negative—hence the absolute value sign.)

Example: Hard-sphere scattering (continued). In the case of hard-sphere scattering (Equation 11.1),

$$\frac{db}{d\theta} = -\frac{1}{2}R \sin\left(\frac{\theta}{2}\right), \quad [11.5]$$

so

$$D(\theta) = \frac{R \cos(\theta/2)}{\sin\theta} \left(\frac{R \sin(\theta/2)}{2} \right) = \frac{R^2}{4}. \quad [11.6]$$

This example is unusual in that the differential cross-section is actually independent of θ .

The **total cross-section** is the *integral* of $D(\theta)$ over all solid angles:

$$\sigma \equiv \int D(\theta) d\Omega; \quad [11.7]$$

roughly speaking, it is the total area of incident beam that is scattered by the target. For example, in the case of the hard sphere,

$$\sigma = (R^2/4) \int d\Omega = \pi R^2, \quad [11.8]$$

which is just what we would expect: It's the cross-sectional area of the sphere; BBs incident within this area will hit the target, and those farther out will miss it completely. But the virtue of the formalism developed here is that it applies just as well to "soft" targets (such as the Coulomb field of a nucleus) that are *not* simply "hit or miss."

Finally, suppose we have a *beam* of incident particles, with uniform intensity (or **luminosity**, as particle physicists call it):

$$\mathcal{L} \equiv \text{number of incident particles per unit area, per unit time.} \quad [11.9]$$

The number of particles entering area $d\sigma$ (and hence scattering into solid angle $d\Omega$), per unit time, is $dN = \mathcal{L}d\sigma = \mathcal{L}D(\theta) d\Omega$, so

$$D(\theta) = \frac{1}{\mathcal{L}} \frac{dN}{d\Omega}. \quad [11.10]$$

This is often taken as the *definition* of the differential cross-section, because it makes reference only to quantities easily measured in the laboratory: If the detector accepts particles scattering into a solid angle $d\Omega$, we simply count the *number* recorded, per unit time, divide by $d\Omega$, and normalize to the luminosity of the incident beam.

*****Problem 11.1** Consider the problem of **Rutherford scattering**: An incident particle of charge q_1 and kinetic energy E scatters off a heavy stationary particle of charge q_2 .

- (a) Derive the formula relating the impact parameter to the scattering angle. *Note*: This is not easy, and you might want to refer to a book on classical mechanics, such as Jerry B. Marion, *Classical Dynamics of Particles and Systems*, 2nd ed. (New York: Academic Press, (1970)), Section 9.5. *Answer*: $b = (q_1 q_2 / 8\pi \epsilon_0 E) \cot(\theta/2)$.
- (b) Determine the differential scattering cross-section. *Answer*:

$$D(\theta) = \left[\frac{q_1 q_2}{16\pi \epsilon_0 E \sin^2(\theta/2)} \right]^2. \quad [11.11]$$

- (c) Show that the total cross-section for Rutherford scattering is *infinite*.

11.1.2 Quantum Scattering Theory

In the quantum theory of scattering, we imagine an incident *plane wave*, $\psi(z) = Ae^{ikz}$, traveling in the z -direction, which encounters a scattering potential, producing

an outgoing *spherical* wave (Figure 11.4).² That is, we will look for solutions to the Schrödinger equation of the general form

$$\psi(r, \theta) \approx A \left\{ e^{ikz} + f(\theta) \frac{e^{ikr}}{r} \right\}, \quad \text{for large } r. \quad [11.12]$$

(The spherical wave must carry a factor of $1/r$, because this portion of $|\psi|^2$ must go like $1/r^2$ to conserve probability.) The wave number k is related to the energy of the incident particles in the usual way:

$$k \equiv \frac{\sqrt{2mE}}{\hbar}. \quad [11.13]$$

(As before, I shall assume the target is azimuthally symmetrical; in the more general case the amplitude f of the outgoing spherical wave could depend on ϕ as well as θ .)

The whole problem is to determine the **scattering amplitude** $f(\theta)$; it tells you the *probability of scattering in a given direction* θ , and hence is related to the differential cross-section. Indeed, the probability that the incident particle, traveling at speed v , passes through the infinitesimal area $d\sigma$, in time dt , is (see Figure 11.5)

$$dP = |\psi_{\text{incident}}|^2 dV = |A|^2 (v dt) d\sigma.$$

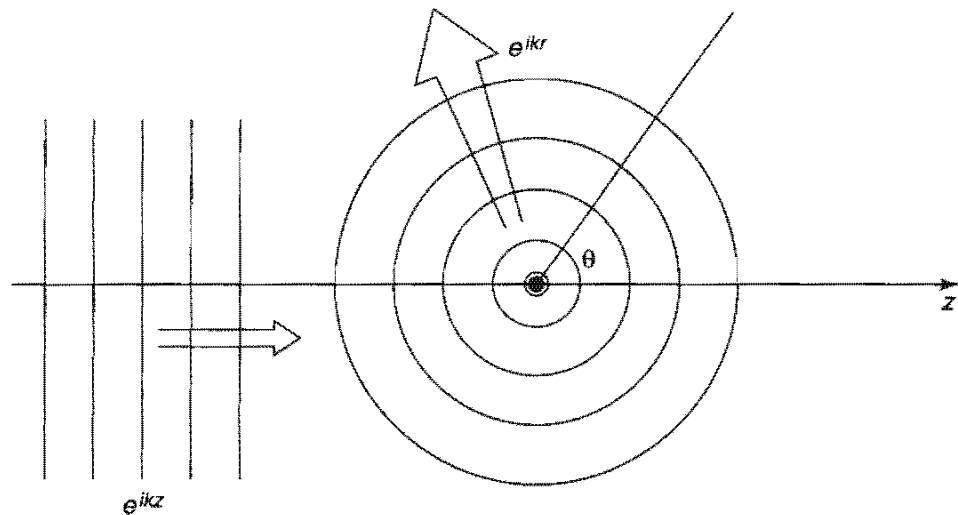

Figure 11.4: Scattering of waves; incoming plane wave generates outgoing spherical wave.

²For the moment, there's not much *quantum* mechanics in this; what we're really talking about is the scattering of *waves*, as opposed to classical *particles*, and you could even think of Figure 11.4 as a picture of water waves encountering a rock, or (better, since we're interested in three-dimensional scattering) sound waves bouncing off a basketball. In that case we'd write the wave function in the *real* form

$$A\{\cos(kz) + f(\theta)\cos(kr + \delta)/r\},$$

and $f(\theta)$ would represent the amplitude of the scattered sound wave in the direction θ .

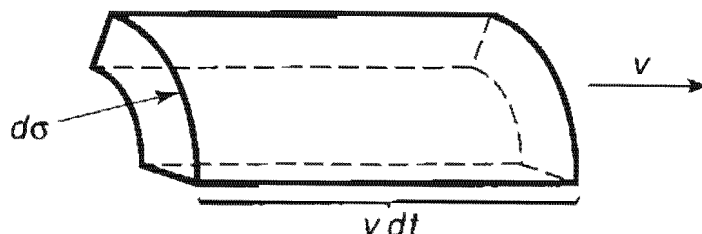

Figure 11.5: The volume dV of incident beam that passes through area $d\sigma$ in time dt .

But this is equal to the probability that the particle later emerges into the corresponding solid angle $d\Omega$:

$$dP = |\psi_{\text{scattered}}|^2 dV = \frac{|A|^2 |f|^2}{r^2} (v dt) r^2 d\Omega,$$

from which it follows that $d\sigma = |f|^2 d\Omega$, so

$$D(\theta) = \frac{d\sigma}{d\Omega} = |f(\theta)|^2. \quad [11.14]$$

Evidently the differential cross-section (which is the quantity of interest to the experimentalist) is equal to the absolute square of the scattering amplitude (which is obtained by solving the Schrödinger equation). In the next sections we will study two techniques for calculating the scattering amplitude: **partial wave analysis** and the **Born approximation**.

Problem 11.2 Construct the analogs to Equation 11.12 for one-dimensional and two-dimensional scattering.

11.2 PARTIAL WAVE ANALYSIS

11.2.1 Formalism

As we found in Chapter 4, the Schrödinger equation for a spherically symmetrical potential $V(r)$ admits the separable solutions

$$\psi(r, \theta, \phi) = R(r) Y_l^m(\theta, \phi), \quad [11.15]$$

where Y_l^m is a spherical harmonic (Equation 4.32) and $u(r) = rR(r)$ satisfies the “radial equation” (Equation 4.37):

$$-\frac{\hbar^2}{2m} \frac{d^2 u}{dr^2} + \left[V(r) + \frac{\hbar^2}{2m} \frac{l(l+1)}{r^2} \right] u = Eu. \quad [11.16]$$

At very large r the potential goes to zero, and the centrifugal term is negligible, so

$$\frac{d^2u}{dr^2} \approx -k^2u.$$

The general solution is

$$u(r) = Ce^{ikr} + De^{-ikr};$$

the first term represents an *outgoing* spherical wave, and the second an *incoming* one—for the scattered wave, we evidently want $D = 0$. At very large r , then,

$$R(r) \approx \frac{e^{ikr}}{r},$$

as we already deduced (on qualitative grounds) in the previous section (Equation 11.12).

That's for very large r (more precisely, for $kr \gg 1$; in optics it would be called the **radiation zone**). As in one-dimensional scattering theory, we assume that the potential is “localized,” in the sense that exterior to some finite scattering region it is essentially zero (Figure 11.6). In the intermediate region (where V can be ignored but the centrifugal term cannot),³ the radial equation becomes

$$\frac{d^2u}{dr^2} - \frac{l(l+1)}{r^2}u = -k^2u, \quad [11.17]$$

and the general solution (as we found in Section 4.1.3) is a linear combination of spherical Bessel functions (Equation 4.45):

$$u(r) = Arj_l(kr) + Brn_l(kr). \quad [11.18]$$

However, neither j_l (which is something like a sine function) nor n_l (which is a sort of generalized cosine function) represents an outgoing (or an incoming) wave. What we need are the linear combinations analogous to e^{ikr} and e^{-ikr} ; these are known as **spherical Hankel functions**:

$$h_l^{(1)}(x) \equiv j_l(x) + in_l(x); \quad h_l^{(2)}(x) \equiv j_l(x) - in_l(x). \quad [11.19]$$

The first few spherical Hankel functions are listed in Table 11.1. At large r , $h_l^{(1)}(kr)$ (the “Hankel function of the first kind”) goes like e^{ikr}/r , whereas $h_l^{(2)}(kr)$ (the “Hankel function of the second kind”) goes like e^{-ikr}/r ; for outgoing waves we evidently need spherical Hankel functions of the *first* kind:

$$R(r) = Ch_l^{(1)}(kr). \quad [11.20]$$

³What follows does not apply to the Coulomb potential, since $1/r$ goes to zero more slowly than $1/r^2$, as $r \rightarrow \infty$, and the centrifugal term does *not* dominate in this region. In this sense the Coulomb potential is not “localized.”

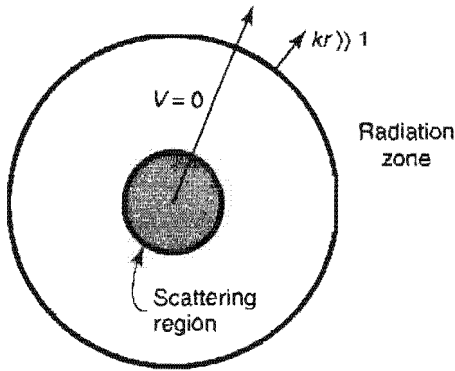

Figure 11.6: Scattering from a localized potential: the scattering region (shaded), the intermediate region (where $V = 0$), and the radiation zone (where $kr \gg 1$).

Thus the exact wave function, in the exterior region [where $V(r) = 0$], is

$$\psi(r, \theta, \phi) = A \left\{ e^{ikz} + \sum_{l,m} C_{l,m} h_l^{(1)}(kr) Y_l^m(\theta, \phi) \right\}. \quad [11.21]$$

Now, for *very large* r , the Hankel function goes like $(-i)^{l+1} e^{ikr} / kr$ (Table 11.1), so

$$\psi(r, \theta, \phi) \approx A \left\{ e^{ikz} + f(\theta, \phi) \frac{e^{ikr}}{r} \right\}, \quad [11.22]$$

where

$$f(\theta, \phi) = \frac{1}{k} \sum_{l,m} (-i)^{l+1} C_{l,m} Y_l^m(\theta, \phi). \quad [11.23]$$

This confirms more rigorously the general structure postulated in Equation 11.12, and tells us how to compute the scattering amplitude, $f(\theta, \phi)$, in terms of the **partial wave amplitudes** $C_{l,m}$. Evidently the differential cross-section is

$$D(\theta, \phi) = |f(\theta, \phi)|^2 = \frac{1}{k^2} \sum_{l,m} \sum_{l',m'} (i)^{l-l'} C_{l,m}^* C_{l',m'} (Y_l^m)^* Y_{l'}^{m'}, \quad [11.24]$$

Table 11.1: Spherical Hankel functions, $h_l^{(1)}(x)$ and $h_l^{(2)}(x)$.

| | |
|---|---|
| $h_0^{(1)} = -i \frac{e^{iz}}{z}$ | $h_0^{(2)} = i \frac{e^{-iz}}{z}$ |
| $h_1^{(1)} = \left(-\frac{i}{z^2} - \frac{1}{z}\right) e^{iz}$ | $h_1^{(2)} = \left(\frac{i}{z^2} - \frac{1}{z}\right) e^{-iz}$ |
| $h_2^{(1)} = \left(-\frac{3i}{z^3} - \frac{3}{z^2} + \frac{i}{z}\right) e^{iz}$ | $h_2^{(2)} = \left(\frac{3i}{z^3} - \frac{3}{z^2} - \frac{i}{z}\right) e^{-iz}$ |
| $\left. \begin{aligned} h_l^{(1)} &\rightarrow \frac{1}{x} \exp \left\{ +i \left[x - \frac{\pi}{2}(l+1) \right] \right\} \\ h_l^{(2)} &\rightarrow \frac{1}{x} \exp \left\{ -i \left[x - \frac{\pi}{2}(l+1) \right] \right\} \end{aligned} \right\} \text{ for } x \gg 1$ | |

and the total cross-section is

$$\sigma = \frac{1}{k^2} \sum_{l,m} \sum_{l',m'} (i)^{l-l'} C_{l,m}^* C_{l',m'} \int (Y_l^m)^* Y_{l'}^{m'} d\Omega = \frac{1}{k^2} \sum_{l,m} |C_{l,m}|^2. \quad [11.25]$$

(I used the orthonormality of the spherical harmonics, Equation 4.33, in the last step.)

In the previous paragraph I kept the possible ϕ dependence because it cost me nothing. But if (as is ordinarily the case) V is independent of ϕ , then only terms with $m = 0$ survive (remember, $Y_l^m \sim e^{im\phi}$). Now (from Equations 4.27 and 4.32)

$$Y_l^0(\theta, \phi) = \sqrt{\frac{2l+1}{4\pi}} P_l(\cos \theta), \quad [11.26]$$

where P_l is the l th Legendre polynomial. So for the case of azimuthal symmetry, the exact wave function (in the exterior region) is

$$\psi(r, \theta) = A \left\{ e^{ikz} + \sum_{l=0}^{\infty} \sqrt{\frac{2l+1}{4\pi}} C_l h_l^{(1)}(kr) P_l(\cos \theta) \right\};$$
[11.27]

the scattering amplitude is

$$f(\theta) = \frac{1}{k} \sum_{l=0}^{\infty} (-i)^{l+1} \sqrt{\frac{2l+1}{4\pi}} C_l P_l(\cos \theta);$$
[11.28]

and the total cross-section is

$$\sigma = \frac{1}{k^2} \sum_{l=0}^{\infty} |C_l|^2. \quad [11.29]$$

11.2.2 Strategy

All that remains is to determine the partial wave amplitudes C_l for the potential in question. This is accomplished by solving the Schrödinger equation in the *interior* region [where $V(r)$ is distinctly *nonzero*] and matching this to the exterior solution (Equation 11.27), using the appropriate boundary conditions. But first I need to do a little cosmetic work, because as it stands my notation is hybrid: I used *spherical* coordinates for the scattered wave, but *Cartesian* coordinates for the incident wave. Before proceeding, it is useful to rewrite the wave function in a more consistent notation.

Of course, e^{ikz} satisfies the Schrödinger equation with $V = 0$. On the other hand, I just argued that the *general* solution to the Schrödinger equation with $V = 0$ can be written in the form

$$\sum_{l,m} [A_{l,m} j_l(kr) + B_{l,m} n_l(kr)] Y_l^m(\theta, \phi).$$

In particular, then, it must be possible to express e^{ikz} in this way. But e^{ikz} is finite at the origin, so no Neumann functions are allowed in the sum [$n_l(kr)$ blows up at $r = 0$], and since $z = r \cos \theta$ has no ϕ dependence, only $m = 0$ terms occur. The expansion of a plane wave in terms of spherical waves is sometimes called **Rayleigh's formula**⁴:

$$e^{ikz} = \sum_{l=0}^{\infty} i^l (2l+1) j_l(kr) P_l(\cos \theta). \quad [11.30]$$

Thus the wave function, in the exterior region, can be written in the more consistent form

$$\psi(r, \theta) = A \sum_{l=0}^{\infty} \left[i^l (2l+1) j_l(kr) + \sqrt{\frac{2l+1}{4\pi}} C_l h_l^{(1)}(kr) \right] P_l(\cos \theta). \quad [11.31]$$

Example: Hard-sphere scattering. Suppose

$$V(r) = \begin{cases} \infty, & \text{for } r \leq a, \\ 0, & \text{for } r > a. \end{cases} \quad [11.32]$$

The boundary condition, then, is

$$\psi(a, \theta) = 0, \quad [11.33]$$

so

$$\sum_{l=0}^{\infty} \left[i^l (2l+1) j_l(ka) + \sqrt{\frac{2l+1}{4\pi}} C_l h_l^{(1)}(ka) \right] P_l(\cos \theta) = 0 \quad [11.34]$$

for all θ , from which it follows (Problem 11.3) that

$$C_l = -i^l \sqrt{4\pi(2l+1)} \frac{j_l(ka)}{h_l^{(1)}(ka)}. \quad [11.35]$$

In particular, the total cross-section is

$$\sigma = \frac{4\pi}{k^2} \sum_{l=0}^{\infty} (2l+1) \left| \frac{j_l(ka)}{h_l^{(1)}(ka)} \right|^2. \quad [11.36]$$

⁴For a guide to the proof, see George Arfken, *Mathematical Methods for Physicists*, 3rd ed. (Orlando, FL: Academic Press, 1985), Exercise 12.4.7, page 665.

That's the *exact* answer, but it's not terribly illuminating, so let's consider the limiting case of *low-energy scattering*: $ka \ll 1$. (Since $k = 2\pi/\lambda$, this amounts to saying that the wavelength is much greater than the radius of the sphere.) Referring to Table 4.3, we note that $n_l(z)$ is much larger than $j_l(z)$, for small z , so

$$\begin{aligned} \frac{j_l(z)}{h_l^{(1)}(z)} &= \frac{j_l(z)}{j_l(z) + in_l(z)} \approx -i \frac{j_l(z)}{n_l(z)} \\ &\approx -i \frac{2^l l! z^l / (2l + 1)!}{-(2l)! z^{-l-1} / 2^l l!} = \frac{i}{2l + 1} \left[\frac{2^l l!}{(2l)!} \right]^2 z^{2l+1}, \end{aligned} \quad [11.37]$$

and hence

$$\sigma \approx \frac{4\pi}{k^2} \sum_{l=0}^{\infty} \frac{1}{2l + 1} \left[\frac{2^l l!}{(2l)!} \right]^4 (ka)^{4l+2}.$$

But we're assuming $ka \ll 1$, so the higher powers are negligible—in the low-energy approximation the scattering is dominated by the $l = 0$ term. (This means that the differential cross-section is independent of θ , just as it was in the classical case.) Evidently

$$\sigma \approx 4\pi a^2, \quad [11.38]$$

for low-energy hard-sphere scattering. Surprisingly, the scattering cross-section is *four times* the geometrical cross-section—in fact, σ is the *total surface area of the sphere*. This “larger effective size” is characteristic of long-wavelength scattering (it would be true in optics, as well); in a sense, these waves “feel” their way around the whole sphere, whereas classical *particles* only see the head-on cross-section.

Problem 11.3 Derive Equation 11.35, starting with Equation 11.34.

****Problem 11.4** Consider the case of low-energy scattering from a spherical delta-function shell:

$$V(r) = \alpha \delta(r - a),$$

where α and a are constants. Calculate the scattering amplitude $f(\theta)$, the differential cross-section $D(\theta)$, and the total cross-section σ . Assume $ka \ll 1$, so that only the $l = 0$ term contributes significantly. (To simplify matters, throw out all $l \neq 0$ terms right from the start. The main problem, of course, is to determine C_0 .) Express your answer in terms of the dimensionless quantity $\phi \equiv 2ma\alpha/\hbar^2$. *Answer:* $\sigma = 4\pi a^2 \phi^2 / (1 + \phi)^2$.

11.3 THE BORN APPROXIMATION

11.3.1 Integral Form of the Schrödinger Equation

The time-independent Schrödinger equation,

$$-\frac{\hbar^2}{2m}\nabla^2\psi + V\psi = E\psi, \quad [11.39]$$

can be written more succinctly as

$$(\nabla^2 + k^2)\psi = Q, \quad [11.40]$$

where

$$k \equiv \frac{\sqrt{2mE}}{\hbar} \quad \text{and} \quad Q \equiv \frac{2m}{\hbar^2}V\psi. \quad [11.41]$$

This has the superficial form of the **Helmholtz equation**; note, however, that the “inhomogeneous” term (Q) *itself* depends on ψ . Suppose we could find a function $G(\mathbf{r})$ that solves the Helmholtz equation with a *delta-function* “source”:

$$(\nabla^2 + k^2)G(\mathbf{r}) = \delta^3(\mathbf{r}). \quad [11.42]$$

Then we could express ψ as an integral:

$$\psi(\mathbf{r}) = \int G(\mathbf{r} - \mathbf{r}_0) Q(\mathbf{r}_0) d^3\mathbf{r}_0. \quad [11.43]$$

For it is easy to show that this satisfies Schrödinger’s equation, in the form of Equation 11.40:

$$\begin{aligned} (\nabla^2 + k^2)\psi(\mathbf{r}) &= \int [(\nabla^2 + k^2)G(\mathbf{r} - \mathbf{r}_0)] Q(\mathbf{r}_0) d^3\mathbf{r}_0 \\ &= \int \delta^3(\mathbf{r} - \mathbf{r}_0) Q(\mathbf{r}_0) d^3\mathbf{r}_0 = Q(\mathbf{r}). \end{aligned}$$

$G(\mathbf{r})$ is called the **Green’s function** for the Helmholtz equation. (In general, the Green’s function for a given differential equation represents the “response” to a delta-function source.)

Our first task⁵ is to solve Equation 11.42 for $G(\mathbf{r})$. This is most easily accomplished by taking the Fourier transform, which turns the *differential* equation into an *algebraic* equation. Let

$$G(\mathbf{r}) = \frac{1}{(2\pi)^{3/2}} \int e^{i\mathbf{s} \cdot \mathbf{r}} g(\mathbf{s}) d^3\mathbf{s}. \quad [11.44]$$

⁵*Warning:* You are approaching two pages of heavy analysis, including contour integration; if you wish, skip straight to the answer, Equation 11.55.

Then

$$(\nabla^2 + k^2)G(\mathbf{r}) = \frac{1}{(2\pi)^{3/2}} \int [(\nabla^2 + k^2)e^{i\mathbf{s} \cdot \mathbf{r}}] g(\mathbf{s}) d^3\mathbf{s}.$$

But

$$\nabla^2 e^{i\mathbf{s} \cdot \mathbf{r}} = -s^2 e^{i\mathbf{s} \cdot \mathbf{r}}, \quad [11.45]$$

and (see Equation 2.126)

$$\delta^3(\mathbf{r}) = \frac{1}{(2\pi)^3} \int e^{i\mathbf{s} \cdot \mathbf{r}} d^3\mathbf{s}, \quad [11.46]$$

so Equation 11.42 says

$$\frac{1}{(2\pi)^{3/2}} \int (-s^2 + k^2) e^{i\mathbf{s} \cdot \mathbf{r}} g(\mathbf{s}) d^3\mathbf{s} = \frac{1}{(2\pi)^3} \int e^{i\mathbf{s} \cdot \mathbf{r}} d^3\mathbf{s}$$

It follows⁶ that

$$g(\mathbf{s}) = \frac{1}{(2\pi)^{3/2}(k^2 - s^2)}. \quad [11.47]$$

Putting this back into Equation 11.44, we find

$$G(\mathbf{r}) = \frac{1}{(2\pi)^3} \int e^{i\mathbf{s} \cdot \mathbf{r}} \frac{1}{(k^2 - s^2)} d^3\mathbf{s}. \quad [11.48]$$

Now \mathbf{r} is *fixed*, as far as the \mathbf{s} integration is concerned, so we may as well choose spherical coordinates (s, θ, ϕ) with the polar axis along \mathbf{r} (Figure 11.7). Then $\mathbf{s} \cdot \mathbf{r} = sr \cos \theta$, the ϕ integral is trivial (2π), and the θ integral is

$$\int_0^\pi e^{isr \cos \theta} \sin \theta d\theta = -\frac{e^{isr \cos \theta}}{isr} \Big|_0^\pi = \frac{2 \sin(sr)}{sr}. \quad [11.49]$$

Thus

$$G(\mathbf{r}) = \frac{1}{(2\pi)^2} \frac{2}{r} \int_0^\infty \frac{s \sin(sr)}{k^2 - s^2} ds = \frac{1}{4\pi^2 r} \int_{-\infty}^\infty \frac{s \sin(sr)}{k^2 - s^2} ds. \quad [11.50]$$

The remaining integral is not so simple. It pays to revert to exponential notation and factor the denominator:

$$\begin{aligned} G(\mathbf{r}) &= \frac{i}{8\pi^2 r} \left\{ \int_{-\infty}^\infty \frac{s e^{isr}}{(s-k)(s+k)} ds - \int_{-\infty}^\infty \frac{s e^{-isr}}{(s-k)(s+k)} ds \right\} \\ &= \frac{i}{8\pi^2 r} (I_1 - I_2). \end{aligned} \quad [11.51]$$

These two integrals can be evaluated using **Cauchy's integral formula**:

$$\oint \frac{f(z)}{(z - z_0)} dz = 2\pi i f(z_0), \quad [11.52]$$

⁶This is clearly *sufficient*, but it is also *necessary*, as you can easily show by combining the two terms into a single integral and using Plancherel's theorem, Equation 2.85.

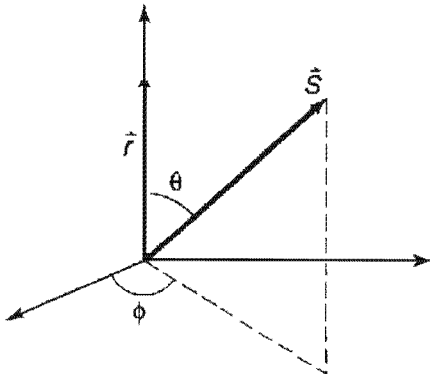

Figure 11.7: Convenient coordinates for the integral in equation [1 1.48].

if z_0 lies within the contour (otherwise the integral is zero). In the present case the integration is along the real axis, and it passes *right over* the pole singularities at $\pm k$. We have to decide how to skirt the poles—I'll go *over* the one at $-k$ and *under* the one at $+k$ (Figure 11.8). (You're welcome to choose some *other* convention if you like—even winding seven times around each pole; you'll get a different Green's function, but, as I'll show you in a minute, they're all equally acceptable.)

For each integral in Equation 11.51 I must "close the contour" in such a way that the semicircle at infinity contributes nothing. In the case of I_1 , the factor e^{isr} goes to zero when s has a large *positive* imaginary part; for this one I close *above* (Figure 11.9a). The contour encloses only the singularity at $s = +k$, so

$$I_1 = \oint \left[\frac{se^{isr}}{s+k} \right] \frac{1}{s-k} ds = 2\pi i \left[\frac{se^{isr}}{s+k} \right] \Big|_{s=k} = i\pi e^{ikr}. \quad [11.53]$$

In the case of I_2 , the factor e^{-isr} goes to zero when s has a large *negative* imaginary part, so we close *below* (Figure 11.9b); this time the contour encloses the singularity at $s = -k$ (and it goes around in the *clockwise* direction, so we pick up a minus sign):

$$I_2 = - \oint \left[\frac{se^{-isr}}{s-k} \right] \frac{1}{s+k} ds = -2\pi i \left[\frac{se^{-isr}}{s-k} \right] \Big|_{s=-k} = -i\pi e^{ikr}. \quad [11.54]$$

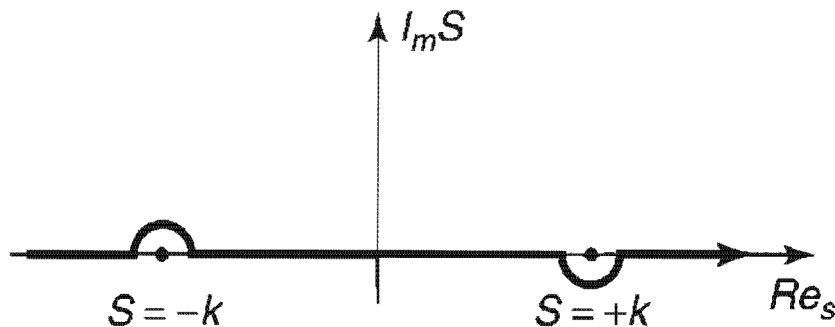

Figure 11.8: Skirting the poles in the contour integral (Equation 11.51).

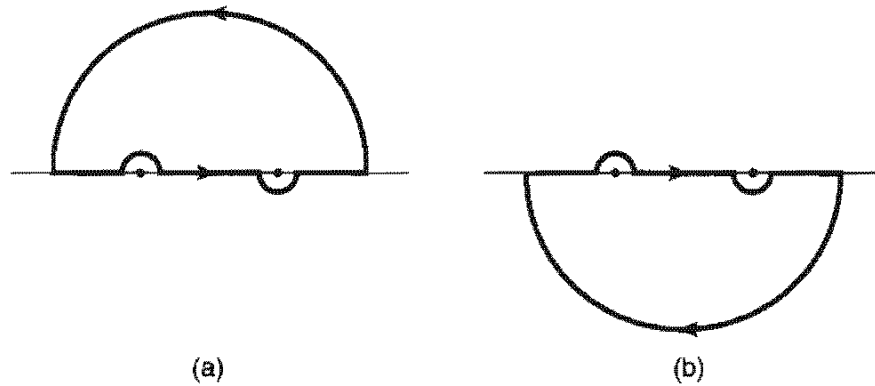

Figure 11.9: Closing the contour in equations [11.53] and [11.54].

Conclusion:

$$G(\mathbf{r}) = \frac{i}{8\pi^2 r} [(i\pi e^{ikr}) - (-i\pi e^{ikr})] = -\frac{e^{ikr}}{4\pi r}. \quad [11.55]$$

This, finally, is the Green's function for the Helmholtz equation—the solution to Equation 11.42. (If you got lost in all that analysis, you might want to *check* the result by direct differentiation—see Problem 11.5.) Or rather, it is *a* Green's function for the Helmholtz equation, for we can add to $G(\mathbf{r})$ any function $G_0(\mathbf{r})$ that satisfies the *homogeneous* Helmholtz equation:

$$(\nabla^2 + k^2)G_0(\mathbf{r}) = 0; \quad [11.56]$$

clearly, the result $(G + G_0)$ still satisfies Equation 11.42. This ambiguity corresponds precisely to the ambiguity in how to skirt the poles—a different choice amounts to picking a different function $G_0(\mathbf{r})$.

Returning to Equation 11.43, the general solution to the Schrödinger equation takes the form

$$\psi(\mathbf{r}) = \psi_0(\mathbf{r}) - \frac{m}{2\pi\hbar^2} \int \frac{e^{ik|\mathbf{r}-\mathbf{r}_0|}}{|\mathbf{r}-\mathbf{r}_0|} V(\mathbf{r}_0)\psi(\mathbf{r}_0) d^3\mathbf{r}_0, \quad [11.57]$$

where ψ_0 satisfies the *free* particle Schrödinger equation,

$$(\nabla^2 + k^2)\psi_0 = 0. \quad [11.58]$$

Equation 11.57 is the **integral form of the Schrödinger equation**; it is entirely equivalent to the more familiar differential form. At first glance it *looks* like an explicit *solution* to the Schrödinger equation (for any potential)—which is too good to be true. Don't be deceived: There's a ψ under the integral sign on the right-hand side, so we can't do the integral unless we already know the solution! Nevertheless,

the integral form can be very powerful, and it is particularly well suited to scattering problems, as we'll see in the following section.

Problem 11.5 Check that Equation 11.55 satisfies Equation 11.42, by direct substitution. *Hint:* $\nabla^2(1/r) = -4\pi\delta^3(\mathbf{r})$.⁷

****Problem 11.6** Show that the ground state of hydrogen (Equation 4.80) satisfies the integral form of the Schrödinger equation, for the appropriate V and E (note that E is negative, so $k = i\kappa$, where $\kappa \equiv \sqrt{-2mE/\hbar}$).

11.3.2 The First Born Approximation

Suppose $V(\mathbf{r}_0)$ is localized about $\mathbf{r}_0 = 0$ —that is, the potential drops to zero outside some finite region (as is typical for a scattering problem), and we want to calculate $\psi(\mathbf{r})$ at points *far away* from the scattering center. Then $|\mathbf{r}| \gg |\mathbf{r}_0|$ for all points that contribute to the integral in Equation 11.57, so

$$|\mathbf{r} - \mathbf{r}_0|^2 = r^2 + r_0^2 - 2\mathbf{r} \cdot \mathbf{r}_0 \cong r^2 \left(1 - 2\frac{\mathbf{r} \cdot \mathbf{r}_0}{r^2}\right), \quad [11.59]$$

and hence

$$|\mathbf{r} - \mathbf{r}_0| \cong r - \hat{\mathbf{r}} \cdot \mathbf{r}_0. \quad [11.60]$$

Let

$$\mathbf{k} \equiv k\hat{\mathbf{r}}; \quad [11.61]$$

then

$$e^{ik|\mathbf{r} - \mathbf{r}_0|} \cong e^{ikr} e^{-i\mathbf{k} \cdot \mathbf{r}_0}, \quad [11.62]$$

and therefore

$$\frac{e^{ik|\mathbf{r} - \mathbf{r}_0|}}{|\mathbf{r} - \mathbf{r}_0|} \cong \frac{e^{ikr}}{r} e^{-i\mathbf{k} \cdot \mathbf{r}_0}. \quad [11.63]$$

[In the *denominator* we can afford to make the more radical approximation $|\mathbf{r} - \mathbf{r}_0| \cong r$; in the *exponent* we need to keep the next term. If this puzzles you, try writing out the next term in the expansion of the denominator. What we are doing is expanding in powers of the small quantity (r_0/r) and dropping all but the lowest order.]

In the case of scattering, we want

$$\psi_0(\mathbf{r}) = Ae^{ikz}, \quad [11.64]$$

representing an incident plane wave. For large r , then,

$$\psi(\mathbf{r}) \cong Ae^{ikz} - \frac{m}{2\pi\hbar^2} \frac{e^{ikr}}{r} \int e^{-i\mathbf{k} \cdot \mathbf{r}_0} V(\mathbf{r}_0) \psi(\mathbf{r}_0) d^3\mathbf{r}_0. \quad [11.65]$$

⁷See, for example, D. J. Griffiths, *Introduction to Electrodynamics*, 2nd ed. (Englewood Cliffs, NJ: Prentice Hall, 1989), p. 52.

This is in the standard form (Equation 11.12), and we can read off the scattering amplitude:

$$f(\theta, \phi) = -\frac{m}{2\pi\hbar^2 A} \int e^{-i\mathbf{k}' \cdot \mathbf{r}_0} V(\mathbf{r}_0) \psi(\mathbf{r}_0) d^3\mathbf{r}_0. \quad [11.66]$$

So far, this is *exact*. Now we invoke the **Born approximation**: Suppose the incoming plane wave is *not substantially altered by the potential*; then it makes sense to use

$$\psi(\mathbf{r}_0) \approx \psi_0(\mathbf{r}_0) = Ae^{ikz_0} = Ae^{i\mathbf{k}' \cdot \mathbf{r}_0}, \quad [11.67]$$

where

$$\mathbf{k}' \equiv k\hat{z}, \quad [11.68]$$

inside the integral. (This would be the *exact* wave function, if V were zero; it is essentially a *weak potential* approximation.) In the Born approximation, then,

$$f(\theta, \phi) \cong -\frac{m}{2\pi\hbar^2} \int e^{i(\mathbf{k}' - \mathbf{k}) \cdot \mathbf{r}_0} V(\mathbf{r}_0) d^3\mathbf{r}_0. \quad [11.69]$$

(In case you have lost track of the definitions of \mathbf{k} and \mathbf{k}' , they both have magnitude k , but the former points in the direction of the incident beam, while the latter points toward the detector—see Figure 11.10.)

In particular, for **low-energy** (long-wavelength) **scattering**, the exponential factor is essentially constant over the scattering region, and the Born approximation simplifies to

$$f(\theta, \phi) \cong -\frac{m}{2\pi\hbar^2} \int V(\mathbf{r}) d^3\mathbf{r}, \quad (\text{low energy}). \quad [11.70]$$

(I dropped the subscript on \mathbf{r} , since there is no occasion for confusion at this point.)

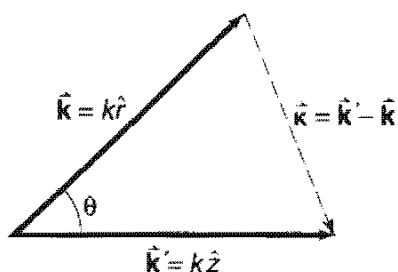

Figure 11.10: Two wave vectors in the Born approximation: \mathbf{k} points in the *incident* direction, \mathbf{k}' in the *scattered* direction.

Example: Low-energy soft-sphere⁸ scattering. Suppose

$$V(\mathbf{r}) = \begin{cases} V_0, & \text{if } r \leq a, \\ 0, & \text{if } r > a. \end{cases} \quad [11.71]$$

In this case the low-energy scattering amplitude is

$$f(\theta, \phi) \cong -\frac{m}{2\pi\hbar^2} V_0 \left(\frac{4}{3} \pi a^3 \right) \quad [11.72]$$

(independent of θ and ϕ), the differential cross-section is

$$\frac{d\sigma}{d\Omega} = |f|^2 \cong \left(\frac{2mV_0a^3}{3\hbar^2} \right)^2, \quad [11.73]$$

and the total cross-section is

$$\sigma \cong 4\pi \left(\frac{2mV_0a^3}{3\hbar^2} \right)^2. \quad [11.74]$$

For a **spherically symmetrical potential**, $V(\mathbf{r}) = V(r)$, (but *not* necessarily at low energy), the Born approximation again reduces to a simpler form. Define

$$\boldsymbol{\kappa} \equiv \mathbf{k}' - \mathbf{k}, \quad [11.75]$$

and let the polar axis for the \mathbf{r}_0 integral lie along $\boldsymbol{\kappa}$, so that

$$(\mathbf{k}' - \mathbf{k}) \cdot \mathbf{r}_0 = \kappa r_0 \cos \theta_0. \quad [11.76]$$

Then

$$f(\theta) \cong -\frac{m}{2\pi\hbar^2} \int e^{i\kappa r_0 \cos \theta_0} V(r_0) r_0^2 \sin \theta_0 dr_0 d\theta_0 d\phi_0. \quad [11.77]$$

The ϕ_0 integral is trivial (2π), and the θ_0 integral is one we have encountered before (see Equation 11.49). Dropping the subscript on r , we are left with

$$f(\theta) \cong -\frac{2m}{\hbar^2 \kappa} \int_0^\infty r V(r) \sin(\kappa r) dr, \quad (\text{spherical symmetry}). \quad [11.78]$$

⁸You can't apply the Born approximation to *hard*-sphere scattering ($V_0 = \infty$)—the integral blows up. The point is that we assumed the potential is *weak*, and doesn't change the wave function much in the scattering region. But a *hard* sphere changes it *radically*—from Ae^{ikz} to zero.

The angular dependence of f is carried by κ ; from Figure 11.10 we see that

$$\kappa = 2k \sin(\theta/2). \quad [11.79]$$

Example: Yukawa scattering. The Yukawa potential (which is a crude model for the binding force in an atomic nucleus) has the form

$$V(r) = \beta \frac{e^{-\mu r}}{r}, \quad [11.80]$$

where β and μ are constants. The Born approximation gives

$$f(\theta) \cong -\frac{2m\beta}{\hbar^2\kappa} \int_0^\infty e^{-\mu r} \sin(\kappa r) dr = -\frac{2m\beta}{\hbar^2(\mu^2 + \kappa^2)}. \quad [11.81]$$

(You get to work out the integral for yourself in Problem 11.8.)

Example: Rutherford scattering. If we put in $\beta = q_1q_2/4\pi\epsilon_0$, $\mu = 0$, the Yukawa potential reduces to the Coulomb potential, describing the electrical interaction of two point charges. Evidently the scattering amplitude is

$$f(\theta) \cong -\frac{2mq_1q_2}{4\pi\epsilon_0\hbar^2\kappa^2}, \quad [11.82]$$

or (using Equations 11.79 and 11.41),

$$f(\theta) \cong -\frac{q_1q_2}{16\pi\epsilon_0 E \sin^2(\theta/2)}. \quad [11.83]$$

The differential cross-section is the square of this:

$$\frac{d\sigma}{d\Omega} = \left[\frac{q_1q_2}{16\pi\epsilon_0 E \sin^2(\theta/2)} \right]^2, \quad [11.84]$$

which is precisely the Rutherford formula (Equation 11.11). It happens that for the Coulomb potential, classical mechanics, the Born approximation, and quantum field theory all yield the same result. In computer parlance, the Rutherford formula is amazingly “robust.”

***Problem 11.7** Find the scattering amplitude, in the Born approximation, for soft-sphere scattering at arbitrary energy. Show that your formula reduces to Equation 11.72 in the low-energy limit.

Problem 11.8 Evaluate the integral in Equation 11.81 to confirm the expression on the right.

****Problem 11.9** Calculate the total cross-section for scattering from a Yukawa potential in the Born approximation. Express your answer as a function of E .

***Problem 11.10** For the potential in Problem 11.4,

- (a) calculate $f(\theta)$, $D(\theta)$, and σ , in the low-energy Born approximation;
- (b) calculate $f(\theta)$ for arbitrary energies, in the Born approximation;
- (c) show that your results are consistent with the answer to Problem 11.4, in the appropriate regime.

11.3.3 The Born Series

The Born approximation is similar in spirit to the **impulse approximation** in classical scattering theory. In the impulse approximation we begin by pretending that the particle keeps going in a straight line (Figure 11.11), and compute the transverse impulse that would be delivered to it in that case:

$$I = \int F_{\perp} dt. \quad [11.85]$$

If the deflection is relatively small, this should be a good approximation to the transverse momentum imparted to the particle, and hence the scattering angle is

$$\theta \cong \tan^{-1}(I/p), \quad [11.86]$$

where p is the incident momentum. This is, if you like, the “first-order” impulse approximation (the *zeroth*-order is what we *started* with: no deflection at all). Likewise, in the zeroth-order Born approximation the incident plane wave passes by with no modification, and what we explored in the previous section is really the first-order correction to this. But the same idea can be iterated to generate a series of higher-order corrections, which presumably converge to the exact answer.

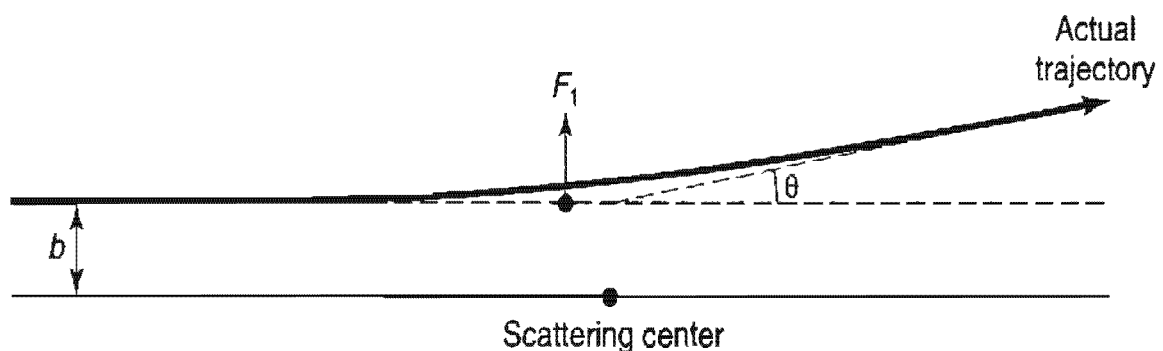

Figure 11.11: The impulse approximation assumes that the particle continues undeflected, and calculates the transverse momentum delivered.

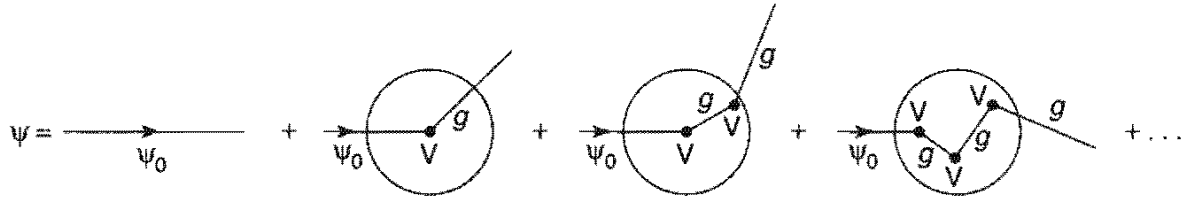

Figure 11.12: Diagrammatic interpretation of the Born series, Equation 11.91.

The integral form of the Schrödinger equation reads

$$\psi(\mathbf{r}) = \psi_0(\mathbf{r}) + \int g(\mathbf{r} - \mathbf{r}_0)V(\mathbf{r}_0)\psi(\mathbf{r}_0) d^3\mathbf{r}_0, \quad [11.87]$$

where ψ_0 is the incident wave,

$$g(\mathbf{r}) \equiv -\frac{m}{2\pi\hbar^2} \frac{e^{ikr}}{r} \quad [11.88]$$

is the Green’s function (into which I have now incorporated the factor $2m/\hbar^2$, for convenience), and V is the scattering potential. Schematically,

$$\psi = \psi_0 + \int gV\psi. \quad [11.89]$$

Suppose we take this expression for ψ , and plug it in under the integral sign:

$$\psi = \psi_0 + \int gV\psi_0 + \int gVgV\psi. \quad [11.90]$$

Iterating this procedure, we obtain a formal series for ψ :

$$\psi = \psi_0 + \int gV\psi_0 + \int gVgV\psi_0 + \int gVgVgV\psi_0 + \dots + \int (gV)^n\psi_0 + \dots. [11.91]$$

In each term only the incident wave function (ψ_0) appears, together with more and more powers of gV . The *first* Born approximation truncates the series after the second term, but it is clear now how one generates the higher-order corrections.

The Born series can be represented diagrammatically as shown in Figure 11.12. In zeroth order ψ is untouched by the potential; in first order it is “kicked” once, and then “propagates” out in some new direction; in second order it is kicked, propagates to a new location, is kicked again, and then propagates out; and so on. In this context the Green’s function is sometimes called the **propagator**—it tells you how the disturbance propagates between one interaction and the next. The Born series was the inspiration for Feynman’s formulation of relativistic quantum mechanics, which is expressed entirely in terms of **vertex factors** (V) and propagators (g), connected together in **Feynman diagrams**.

Problem 11.11 Calculate θ (as a function of the impact parameter) for Rutherford scattering, in the impulse approximation. Show that your result is consistent with the exact expression (Problem 11.1a) in the appropriate limit.

*****Problem 11.12** Find the scattering amplitude for low-energy soft-sphere scattering in the *second* Born approximation. *Answer:* $-(2mV_0a^3/3\hbar^2)[1 - (4mV_0a^2/5\hbar^2)]$.

FURTHER PROBLEMS FOR CHAPTER 11

*****Problem 11.13** Find the Green's function for the *one*-dimensional Schrödinger equation, and use it to construct the integral form (analogous to Equation 11.57). *Answer:*

$$\psi(x) = \psi_0(x) - \frac{im}{\hbar^2 k} \int_{-\infty}^{\infty} e^{ik|x-x_0|} V(x_0) \psi(x_0) dx_0. \quad [11.92]$$

****Problem 11.14** Use your result in Problem 11.13 to develop the Born approximation for one-dimensional scattering. That is, choose $\psi_0(x) = Ae^{ikx}$, and assume $\psi(x_0) \cong \psi_0(x_0)$ to evaluate the integral. Show that the reflection coefficient takes the form

$$R \cong \left(\frac{m}{\hbar^2 k} \right)^2 \left| \int_{-\infty}^{\infty} e^{2ikx} V(x) dx \right|^2. \quad [11.93]$$

Problem 11.15 Use the one-dimensional Born approximation (Problem 11.14) to compute the transmission coefficient ($T = 1 - R$) for scattering from a delta function (Equation 2.96) and from a finite square well (Equation 2.127). Compare your results with the exact answers (Equations 2.123 and 2.151).

AFTERWORD

Now that you have (I hope) a sound understanding of what quantum mechanics *says*, I should like to return to the question of what it *means*—continuing the story begun in Section 1.2. The source of the problem is the indeterminacy associated with the statistical interpretation of the wave function. For Ψ (or, more generally, the *quantum state*—it could be a spinor, for example) does not uniquely determine the outcome of a measurement; all it provides is the statistical distribution of all possible results. This raises a profound question: Did the physical system “actually have” the attribute in question *prior* to the measurement (the so-called **realist** viewpoint), or did the act of measurement itself “create” the property, limited only by the statistical constraint imposed by the wave function (the **orthodox** position)—or can we duck the question entirely, on the grounds that it is “metaphysical” (the **agnostic** response)?

According to the realist, quantum mechanics is an *incomplete* theory, for even if you know *everything quantum mechanics has to tell you* about the system (to wit, its wave function), you still cannot determine all of its features. Evidently there is some *other* information, external to quantum mechanics, which (together with Ψ) is required for a complete description of physical reality.

The orthodox position raises even more disturbing problems, for if the act of measurement forces the system to “take a stand,” helping to *create* an attribute that was not there previously,¹ then there is something very peculiar about the measurement process. Moreover, to account for the fact that an immediately repeated measurement yields the same result, we are forced to assume that the act of measurement **collapses**

¹This may be *strange*, but it is not *mystical*, as some popularizers would like to suggest. The so-called **wave-particle duality**, which Niels Bohr elevated into a cosmic principle (**complementarity**), makes electrons sound like unpredictable adolescents, who sometimes behave like adults, and sometimes, for no particular reason, like children. I prefer to avoid such language. When I say that a particle does not have a particular attribute until a measurement intervenes, I have in mind, for example, an electron in the spin state $\chi = \begin{pmatrix} 1 \\ 0 \end{pmatrix}$; a measurement of the x -component of its angular momentum could return the value $\hbar/2$, or (with equal probability) the value $-\hbar/2$, but until the measurement is made it simply *does not have* a well-defined value of S_x .

the wave function, in a manner that is difficult, at best, to reconcile with the normal evolution prescribed by the Schrödinger equation.

In light of this, it is no wonder that generations of physicists retreated to the agnostic position, and advised their students not to waste time worrying about the conceptual foundations of the theory.

A.1 The EPR Paradox

In 1935, Einstein, Podolsky, and Rosen² published the famous **EPR paradox**, which was designed to prove (on purely theoretical grounds) that the realist position is the only sustainable one. I'll describe a simplified version of the EPR paradox, due to David Bohm. Consider the decay of the neutral pi meson into an electron and a positron:

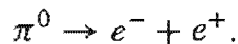

Assuming the pion was at rest, the electron and positron fly off in opposite directions (Figure A.1). Now, the pion has spin zero, so conservation of angular momentum requires that the electron and positron are in the singlet configuration:

$$\frac{1}{\sqrt{2}}(\uparrow\downarrow + \downarrow\uparrow). \quad [\text{A.1}]$$

If the electron is found to have spin up, the positron must have spin down, and vice versa. Quantum mechanics can't tell you *which* combination you'll get, in any particular pion decay, but it does say that the measurements will be *correlated*, and you'll get each combination half the time (on average). Now suppose we let the electron and positron fly *way* off—10 meters, in a practical experiment, or, in principle, 10 light years—and then you measure the spin of the electron. Say you get spin up. Immediately you know that someone 20 meters (or 20 light years) away will get spin down, if that person examines the positron.

To the realist, there's nothing surprising in this—the electron *really had* spin up (and the positron spin down) from the moment they were created—it's just that quantum mechanics didn't know about it. But the "orthodox" view holds that neither particle had either spin up *or* spin down until the act of measurement intervened: Your measurement of the electron collapsed the wave function, and instantaneously "produced" the spin of the positron 20 meters (or 20 light years) away. Einstein, Podolsky, and Rosen considered any such "spooky action-at-a-distance" (Einstein's words) preposterous. They concluded that the orthodox position is untenable; the



Figure A.1: Bohm's version of the EPR experiment: π^0 at rest decays into electron-positron pair.

²A. Einstein, B. Podolsky, and N. Rosen, *Phys. Rev.* **47**, 777 (1935).

electron and positron must have had well-defined spins all along, whether quantum mechanics can calculate them or not.

The fundamental assumption on which the EPR argument rests is that no influence can propagate faster than the speed of light. We call this the principle of **locality**. You might be tempted to propose that the collapse of the wave function is *not* instantaneous, but somehow “travels” out at some finite velocity. However, this would lead to violations of angular momentum conservation, for if we measured the spin of the positron before the news of the collapse had reached it, there would be a 50-50 probability of finding *both* particles with spin up. Whatever one might think of such a theory in the abstract, the experiments are unambiguous: No such violation occurs—the correlation of the spins is perfect.

A.2 Bell's Theorem

Einstein, Podolsky, and Rosen did not doubt that quantum mechanics is *correct*, as far as it goes; they only claimed that it is an *incomplete* description of physical reality: The wave function is not the whole story—some *other* quantity, λ , is needed, in addition to Ψ , to characterize the state of a system fully. We call λ the “hidden variable” because, at this stage, we have no idea how to calculate or measure it.³ Over the years, a number of hidden variable theories have been proposed, to supplement quantum mechanics; they tend to be cumbersome and implausible, but never mind—until 1964 the program seemed eminently worth pursuing. But in that year J. S. Bell proved that *any* local hidden variable theory is *incompatible* with quantum mechanics.⁴

Bell suggested a generalization of the EPR/Bohm experiment: Instead of orienting the electron and positron detectors along the *same* direction, he allowed them to be rotated independently. The first measures the component of the electron spin in the direction of a unit vector \mathbf{a} , and the second measures the spin of the positron along the direction \mathbf{b} (Figure A.2). For simplicity, let's record the spins in units of $\hbar/2$; then each detector registers the value +1 (for spin up) or -1 (spin down), along the direction in question. A table of results, for many π^0 decays, might look like this:

| electron | positron | product |
|----------|----------|---------|
| +1 | -1 | -1 |
| +1 | +1 | +1 |
| -1 | +1 | -1 |
| +1 | -1 | -1 |
| -1 | -1 | +1 |
| ⋮ | ⋮ | ⋮ |

³The hidden variable could be a single number, or it could be a whole *collection* of numbers; perhaps λ is to be calculated in some future theory, or maybe it is for some reason of principle incalculable. It hardly matters. All I am asserting is that there must be *something*—if only a *list* of the outcomes of every possible experiment—associated with the system prior to a measurement.

⁴Bell's original paper [*Physics* 1, 195 (1964)] is a gem: brief, accessible, and beautifully written.

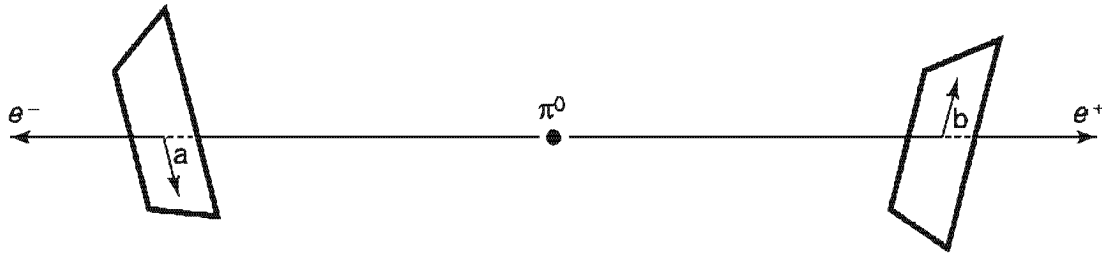

Figure A.2: Bell's version of the EPR-Bohm experiment: detectors independently oriented in directions \mathbf{a} and \mathbf{b} .

Bell proposed to calculate the *average* value of the *product* of the spins, for a given set of detector orientations. Call this average $P(\mathbf{a}, \mathbf{b})$. If the detectors are parallel ($\mathbf{b} = \mathbf{a}$), we recover the original EPRB configuration; in this case one is spin up and the other spin down, so the product is always -1 , and hence so too is the average:

$$P(\mathbf{a}, \mathbf{a}) = -1. \quad [\text{A.2}]$$

By the same token, if they are *anti-parallel* ($\mathbf{b} = -\mathbf{a}$), then every product is $+1$, so

$$P(\mathbf{a}, -\mathbf{a}) = +1. \quad [\text{A.3}]$$

For arbitrary orientations, quantum mechanics predicts

$$P(\mathbf{a}, \mathbf{b}) = -\mathbf{a} \cdot \mathbf{b} \quad [\text{A.4}]$$

(see Problem 4.44). What Bell discovered is that this result is impossible in any local hidden variable theory.

The argument is stunningly simple. Suppose that the “complete” state of the electron/positron system is characterized by the hidden variable(s) λ ; λ varies, in some way that we neither understand nor control, from one pion decay to the next. Suppose further that the outcome of the *electron* measurement is independent of the orientation (\mathbf{b}) of the *positron* detector—which may, after all, be chosen by the experimenter at the positron end just before the electron measurement is made, and hence far too late for any subluminal message to get back to the electron detector. (This is the locality assumption.) Then there exists some function $A(\mathbf{a}, \lambda)$ which gives the result of an electron measurement, and some other function $B(\mathbf{b}, \lambda)$ for the positron measurement. These functions can only⁵ take on the values ± 1 :

$$A(\mathbf{a}, \lambda) = \pm 1; \quad B(\mathbf{b}, \lambda) = \pm 1. \quad [\text{A.5}]$$

⁵This already concedes far more than a *classical* determinist would be prepared to allow, for it abandons any notion that the particles could have well-defined angular momentum vectors with simultaneously determinate components. But never mind—the point of Bell's argument is to demonstrate that quantum mechanics is incompatible with *any* local deterministic theory—even one that bends over backward to be accommodating.

When the detectors are aligned, the results are perfectly (anti)correlated:

$$A(\mathbf{a}, \lambda) = -B(\mathbf{a}, \lambda), \quad [\text{A.6}]$$

for all λ .

Now, the average of the product of the measurements is

$$P(\mathbf{a}, \mathbf{b}) = \int \rho(\lambda) A(\mathbf{a}, \lambda) B(\mathbf{b}, \lambda) d\lambda, \quad [\text{A.7}]$$

where $\rho(\lambda)$ is the probability density for the hidden variable. [Like any probability density, it is nonnegative, and satisfies the normalization condition $\int \rho(\lambda) d\lambda = 1$, but beyond this we make no assumptions about $\rho(\lambda)$; different hidden variable theories would presumably deliver quite different expressions for ρ .] In view of Equation A.6, we can eliminate B:

$$P(\mathbf{a}, \mathbf{b}) = - \int \rho(\lambda) A(\mathbf{a}, \lambda) A(\mathbf{b}, \lambda) d\lambda. \quad [\text{A.8}]$$

If \mathbf{c} is any *other* unit vector,

$$P(\mathbf{a}, \mathbf{b}) - P(\mathbf{a}, \mathbf{c}) = - \int \rho(\lambda) [A(\mathbf{a}, \lambda) A(\mathbf{b}, \lambda) - A(\mathbf{a}, \lambda) A(\mathbf{c}, \lambda)] d\lambda. \quad [\text{A.9}]$$

Or, since $[A(\mathbf{b}, \lambda)]^2 = 1$:

$$P(\mathbf{a}, \mathbf{b}) - P(\mathbf{a}, \mathbf{c}) = - \int \rho(\lambda) [1 - A(\mathbf{b}, \lambda) A(\mathbf{c}, \lambda)] A(\mathbf{a}, \lambda) A(\mathbf{b}, \lambda) d\lambda. \quad [\text{A.10}]$$

But it follows from Equation A.5 that $-1 \leq [A(\mathbf{a}, \lambda) A(\mathbf{b}, \lambda)] \leq +1$, and $\rho(\lambda)[1 - A(\mathbf{b}, \lambda) A(\mathbf{c}, \lambda)] \geq 0$, so

$$|P(\mathbf{a}, \mathbf{b}) - P(\mathbf{a}, \mathbf{c})| \leq \int \rho(\lambda) [1 - A(\mathbf{b}, \lambda) A(\mathbf{c}, \lambda)] d\lambda, \quad [\text{A.11}]$$

or, more simply,

$$\boxed{|P(\mathbf{a}, \mathbf{b}) - P(\mathbf{a}, \mathbf{c})| \leq 1 + P(\mathbf{b}, \mathbf{c})}. \quad [\text{A.12}]$$

This is the famous **Bell inequality**. It holds for *any* local hidden variable theory (subject only to the minimal requirements of Equations A.5 and A.6), for we have made no assumptions whatever as to the nature or number of the hidden variables or their distribution (ρ).

But it is easy to show that the quantum mechanical prediction (Equation A.4) is incompatible with Bell's inequality. For example, suppose all three vectors lie in

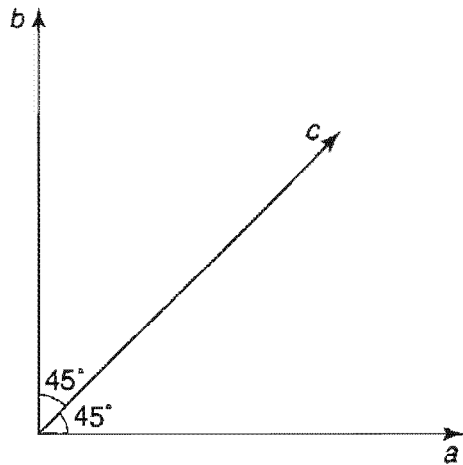

Figure A.3: An orientation of the detectors that demonstrates quantum violations of Bell's inequality.

a plane, and c makes a 45° angle with a and b (Figure A.3); in this case quantum mechanics says

$$P(\mathbf{a}, \mathbf{b}) = 0, \quad P(\mathbf{a}, \mathbf{c}) = P(\mathbf{b}, \mathbf{c}) = -0.707,$$

which is patently inconsistent with Bell's inequality:

$$0.707 \not\leq 1 - 0.707 = 0.293.$$

With Bell's modification, then, the EPR paradox proves something far more radical than its authors imagined: If they are right, then not only is quantum mechanics *incomplete*, it is downright *wrong*. On the other hand, if quantum mechanics is right, then *no* hidden variable theory is going to rescue us from the nonlocality Einstein considered so preposterous. Moreover, we are provided with a very simple experiment to settle the issue once and for all.

Many experiments to test Bell's inequality were performed in the 1960s and 1970's, culminating in the work of Aspect, Grangier, and Roger.⁶ The details do not concern us here (they actually used two-photon atomic transitions, not pion decays). To exclude the remote possibility that the positron detector might somehow "sense" the orientation of the electron detector, both orientations were set quasi-randomly *after* the photons were already in flight. The results were in excellent agreement with the predictions of quantum mechanics and clearly incompatible with Bell's inequality.⁷

Ironically, the experimental confirmation of quantum mechanics came as something of a shock to the scientific community. But not because it spelled the demise of "realism"—most physicists had long since adjusted to this (and for those who could

⁶A. Aspect, P. Grangier, and G. Roger, *Phys. Rev. Lett.* **49**, 91 (1982).

⁷Bell's theorem involves *averages*, and it is conceivable that an apparatus such as Aspect's contains some secret bias which selects out a nonrepresentative sample, thus distorting the average. Recently, an improved version of Bell's theorem has been proposed in which a *single measurement* suffices to distinguish between the quantum prediction and that of any local hidden variable theory. See D. Greenberger, M. Horne, A. Shimony, and A. Zeilinger, *Am. J. Phys.* **58**, 1131, (1990) and N. David Mermin, *Am. J. Phys.* **58**, 731, (1990).



Figure A.4: The shadow of the bug moves across the screen at a velocity v' greater than c , provided that the screen is far enough away.

not, there remained the possibility of *nonlocal* hidden variable theories, to which Bell's theorem does not apply⁸). The real shock was the proof that *nature itself is fundamentally nonlocal*. Nonlocality, in the form of the instantaneous collapse of the wave function (and for that matter also in the symmetrization requirement for identical particles) had always been a feature of the orthodox interpretation, but before Aspect's experiment it was possible to hope that quantum nonlocality was somehow a nonphysical artifact of the formalism, with no detectable consequences. That hope can no longer be sustained, and we are obliged to reexamine our objection to instantaneous action at a distance.

Why *are* physicists so alarmed at the idea of superluminal influences? After all, there are many things that travel faster than light. If a bug flies across the beam of a movie projector, the speed of its shadow is proportional to the distance to the screen; in principle, that distance can be as large as you like, and hence the *shadow* can move at arbitrarily high velocity (Figure A.4). However, the shadow does not carry any *energy*; nor can it transmit any *message* from one point to another on the screen. A person at point X cannot *cause anything to happen* at point Y by manipulating the passing shadow.

On the other hand, a *causal* influence that propagated faster than light would carry unacceptable implications. For according to special relativity there exist inertial frames in which such a signal propagates *backward in time*—the effect preceding the cause—and this leads to inescapable logical anomalies. (You could, for example, arrange to kill your infant grandfather.) The question is, are the superluminal influences predicted by quantum mechanics and detected by Aspect *causal*, in this sense,

⁸It is a curious twist of fate that the EPR paradox, which *assumed* locality to *prove* realism, led finally to the repudiation of locality and left the issue of realism undecided—the outcome (as Mermin put it) Einstein would have liked *least*. Most physicists today consider that if they can't have *local* realism, there's not much point in realism at *all*, and for this reason nonlocal hidden variable theories occupy a rather peripheral place. Still, some authors—notably Bell himself, in *Speakable and Unspeakable in Quantum Mechanics* (Cambridge University Press, Cambridge, 1987)—argue that such theories offer the best hope of bridging the gap between the measured system and the measuring apparatus, and for supplying an intelligible mechanism for the collapse of the wave function.

or are they somehow ethereal enough (like the motion of the shadow) to escape the philosophical objection?

Well, let's consider Bell's experiment. Does the measurement of the electron *influence* the outcome of the positron measurement? Assuredly it *does*—otherwise we cannot account for the correlation of the data. But does the measurement of the electron *cause* a particular outcome for the positron? Not in any ordinary sense of the word. There is no way the person monitoring the electron detector could use his measurement to send a signal to the person at the positron detector, since he does not control the outcome of his own measurement (he cannot *make* a given electron come out spin up, any more than the person at *X* can affect the passing shadow of the bug). It is true that he can decide *whether to make a measurement at all*, but the positron monitor, having immediate access only to data at his end of the line, cannot tell whether the electron was measured or not. For the lists of data compiled at the two ends, considered separately, are completely random. It is only when we *compare* the two lists later that we discover the remarkable correlations. In another reference frame, the positron measurements occur *before* the electron measurements, and yet this leads to no logical paradox—the observed correlation is entirely symmetrical in its treatment, and it is a matter of indifference whether we say the observation of the electron influenced the measurement of the positron, or the other way around. This is a wonderfully delicate kind of influence, whose only manifestation is a subtle correlation between two lists of otherwise random data.

We are led, then, to distinguish two types of influence: the “causal” variety, which produce actual changes in some physical property of the receiver, detectable by measurements on that subsystem alone, and an “ethereal” kind, which do not transmit energy or information, and for which the only evidence is a correlation in the data taken on the two separate subsystems—a correlation which by its nature cannot be detected by examining either list alone. Causal influences *cannot* propagate faster than light, but there is no compelling reason why ethereal ones should not. The influences associated with the collapse of the wave function are of the latter type, and the fact that they “travel” faster than light may be surprising, but it is not, after all, catastrophic.⁹

A.3 What is a Measurement?

The measurement process plays a mischievous role in quantum mechanics: It is here that indeterminacy, nonlocality, the collapse of the wave function, and all the attendant conceptual difficulties arise. Absent measurement, the wave function evolves in a leisurely and deterministic way, according to the Schrödinger equation, and quantum mechanics looks like a rather ordinary field theory [much simpler than classical

⁹An enormous amount has been written about Bell's theorem. My favorite is an inspired essay by David Mermin in *Physics Today* (April 1985, page 38). An extensive bibliography will be found in L. E. Ballentine, *Am. J. Phys.* **55**, 785 (1987).

electrodynamics, for example, since there is only *one* field (Ψ), instead of *two* (\mathbf{E} and \mathbf{B}), and it's a *scalar*]. It is the bizarre role of the measurement process that gives quantum mechanics its extraordinary richness and subtlety. But what, exactly, *is* a measurement? What makes it so different from other physical processes?¹⁰ And how can we tell when a measurement has occurred?

Schrödinger posed the essential question most starkly, in his famous **cat paradox**:¹¹

A cat is placed in a steel chamber, together with the following hellish contraption In a Geiger counter there is a tiny amount of radioactive substance, so tiny that maybe within an hour one of the atoms decays, but equally probably none of them decays. If one decays then the counter triggers and via a relay activates a little hammer which breaks a container of cyanide. If one has left this entire system for an hour, then one would say the cat is living if no atom has decayed. The first decay would have poisoned it. The wave function of the entire system would express this by containing equal parts of the living and dead cat.

At the end of the hour, the wave function of the cat has the schematic form

$$\psi = \frac{1}{\sqrt{2}}(\psi_{\text{alive}} + \psi_{\text{dead}}). \quad [\text{A.13}]$$

The cat is neither alive nor dead, but rather a linear combination of the two, until a measurement occurs—until, say, you peek in the window to check. At that moment your observation forces the cat to “take a stand”: dead or alive. And if you find it to be dead, then it's really *you* who killed it, by looking in the window.

Schrödinger regarded this as patent nonsense, and I think most physicists would agree with him. There is something absurd about the very idea of a *macroscopic* object being in a linear combination of two palpably different states. An electron can be in a linear combination of spin up and spin down, but a cat simply cannot *be* in a linear combination of alive and dead. How are we to reconcile this with the orthodox interpretation of quantum mechanics?

The most widely accepted answer is that the triggering of the Geiger counter constitutes the “measurement,” in the sense of the statistical interpretation, not the intervention of a human observer. It is the essence of a measurement that some *macroscopic* system is affected (the Geiger counter, in this instance). The measurement occurs at the moment when the microscopic system (described by the laws of

¹⁰There is a school of thought that rejects this distinction, holding that the system and the measuring apparatus should be described by one great big wave function which itself evolves according to the Schrödinger equation. In such theories there is no collapse of the wave function, but one must typically abandon any hope of describing individual events—quantum mechanics (in this view) applies only to *ensembles* of identically prepared systems. See, for example, Philip Pearle *Am. J. Phys.* **35**, 742 (1967), or, more recently, Leslie E. Ballentine, *Quantum Mechanics*, (Prentice Hall, Englewood Cliffs, NJ, 1990).

¹¹E. Schrödinger, *Naturwiss.* **48**, 52 (1935); translation by Josef M. Jauch, *Foundations of Quantum Mechanics*, (Reading, MA: Addison-Wesley, 1968), p. 185.

quantum mechanics) interacts with the macroscopic system (described by the laws of classical mechanics) in such a way as to leave a permanent record. The macroscopic system itself is not permitted to occupy a linear combination of distinct states.¹²

I would not pretend that this is an entirely satisfactory resolution, but at least it avoids the stultifying solipsism of Wigner and others, who persuaded themselves that it is the intervention of human consciousness that constitutes a measurement in quantum mechanics. Part of the problem is the word “measurement” itself, which certainly carries an suggestion of human involvement. Heisenberg proposed the word “event”, which might be preferable. But I’m afraid “measurement” is so ingrained by now that we’re stuck with it. And, in the end, no manipulation of the terminology can completely exorcise this mysterious ghost.

A.4 The Quantum Zeno Paradox

The collapse of the wave function is undoubtedly the *most* peculiar feature of this whole story. It was introduced on purely theoretical grounds, to account for the fact that an immediately repeated measurement reproduces the same value. But surely such a radical postulate must carry directly observable consequences. In 1977 Misra and Sudarshan¹³ proposed what they called the **quantum Zeno effect** as a dramatic experimental demonstration of the collapse of the wave function. Their idea was to take an unstable system (an atom in an excited state, say) and subject it to repeated measurements. Each observation collapses the wave function, resetting the clock, and it is possible by this means to delay indefinitely the expected transition to the lower state.¹⁴

Specifically, suppose a system starts out in the excited state ψ_2 , which has a natural lifetime τ for transition to the ground state ψ_1 . Ordinarily, for times substantially less than τ , the probability of a transition is proportional to t (see Equation 9.42); in fact, since the transition rate is $1/\tau$,

$$P_{2 \rightarrow 1} = \frac{t}{\tau}. \quad [\text{A.14}]$$

If we make a measurement after a time t , then, the probability that the system is still in the *upper* state is

$$P_1(t) = 1 - \frac{t}{\tau}. \quad [\text{A.15}]$$

¹²Of course, in some ultimate sense the macroscopic system is *itself* described by the laws of quantum mechanics. But wave functions, in the first instance, describe individual elementary particles; the wave function of a macroscopic object would be a monstrously complicated composite, built out of all the wave functions of its 10^{23} constituent particles. Presumably somewhere in the statistics of large numbers macroscopic linear combinations become extremely improbable.

¹³B. Misra and E. C. G. Sudarshan, *J. Math. Phys.* **18**, 756 (1977).

¹⁴This phenomenon doesn’t have much to do with Zeno, but it *is* reminiscent of the old adage “a watched pot never boils,” so it is sometimes called the **watched pot effect**.

Suppose we *do* find it to be in the upper state. In that case the wave function collapses back to ψ_2 , and the process starts all over again. If we make a *second* measurement, at $2t$, the probability that the system is *still* in the upper state is evidently

$$\left(1 - \frac{t}{\tau}\right)^2 \approx 1 - \frac{2t}{\tau}, \quad [\text{A.16}]$$

which is the same as it would have been had we never made the measurement at t . This is certainly what one would naively expect; if it were the whole story there would be nothing gained by observing the system, and there would be no quantum Zeno effect.

However, for *extremely* short times, the probability of a transition is *not* proportional to t , but rather to t^2 (see Equation 9.39)¹⁵:

$$P_{2 \rightarrow 1} = \alpha t^2. \quad [\text{A.17}]$$

In this case the probability that the system is still in the upper state after the two measurements is

$$(1 - \alpha t^2)^2 \approx 1 - 2\alpha t^2, \quad [\text{A.18}]$$

whereas if we had never made the first measurement it would have been

$$1 - \alpha(2t)^2 \approx 1 - 4\alpha t^2. \quad [\text{A.19}]$$

Evidently our observation of the system after time t *decreased* the net probability of a transition to the lower state!

Indeed, if we examine the system at n regular intervals, from $t = 0$ out to $t = T$ (that is, we make measurements at $T/n, 2T/n, 3T/n, \dots, T$), the probability that the system is still in the upper state at the end is

$$(1 - \alpha(T/n)^2)^n \approx 1 - \frac{\alpha}{n} T^2, \quad [\text{A.20}]$$

which goes to 1 in the limit $n \rightarrow \infty$: A *continuously* observed unstable system never decays at all! Some authors regard this as an absurd conclusion, and a proof that the collapse of the wave function is fallacious. However, their argument hinges on a rather loose interpretation of what constitutes “observation.” If the track of a particle in a bubble chamber amounts to “continuous observation,” then the case is closed, for such particles certainly do decay (in fact, their lifetime is not measurably extended by the presence of the detector). But such a particle is only intermittently interacting with the atoms in the chamber, and for the quantum Zeno effect to occur the successive measurements must be made *extremely* rapidly to catch the system in the t^2 regime.

¹⁵In the argument leading to linear time dependence, we assumed that the function $\sin^2(\Omega t/2)/\Omega^2$ in Equation 9.39 was a sharp spike. However, the *width* of the “spike” is of order $\Delta\omega = 4\pi/t$, and for *extremely* short t this approximation fails, and the integral becomes $(t^2/4) \int \rho(\omega) d\omega$.

As it turns out, the experiment is impractical for spontaneous transitions, but it can be done using *induced* transitions, and the results are in excellent agreement with the theoretical predictions.¹⁶ Unfortunately, this experiment is not as compelling a confirmation of the collapse of the wave function as its designers hoped; the observed effect can be accounted for in other ways.¹⁷

In this book I have tried to present a consistent and coherent story: The wave function (Ψ) represents the state of a particle (or system); particles do not in general possess specific dynamical properties (position, momentum, energy, angular momentum, etc.) until an act of measurement intervenes; the probability of getting a particular value in any given experiment is determined by the statistical interpretation of Ψ ; upon measurement the wave function collapses, so that an immediately repeated measurement is certain to yield the same result. There are other possible interpretations—nonlocal hidden variable theories, the **many worlds** picture, ensemble models, and others—but I believe this one is conceptually the *simplest*, and certainly it is the one shared by most physicists today. It has stood the test of time, and emerged unscathed from every experimental challenge. But I cannot believe this is the end of the story; at the very least, we have much to learn about the nature of measurement and the mechanism of collapse. And it is entirely possible that future generations will look back, from the vantage point of a more sophisticated theory, and wonder how we could have been so gullible.

¹⁶W. M. Itano, D. J. Heinzen, J. J. Bollinger, and D. J. Wineland, *Phys. Rev. A* **41**, 2295 (1990).

¹⁷L. E. Ballentine, *Found. Phys.* **20**, 1329 (1990); T. Petrosky, S. Tasaki, and I. Prigogine, *Phys. Lett. A* **151**, 109 (1990).

INDEX

A

Absorption, 307–8
Addition of angular momenta, 165–70
Addition of vectors, 76
Adiabatic:
 approximation, 323–51
 process, 323–25
 series, 350–51
 theorem, 324–30
Adjoint, 83
Agnostic position, 4, 374
Aharonov-Bohm effect, 343–49
Airy:
 equation, 286
 function, 286–88
Allowed energy, 23
 band, 201
 bouncing ball, 292
 delta function well, 55
 finite square well, 62–63
 harmonic oscillator, 35, 40, 292
 three-dimensional, 170
 helium atom, 187–89
 hydrogen atom, 137, 242–43, 295
 infinite spherical well, 132
 infinite square well, 26
 three-dimensional, 124, 193–95, 231–32
 potential well:
 no vertical walls, 290–92
 one vertical wall, 289–90
 two vertical walls, 278
 power-law potential, 293–94
Allowed transition, 322

Alpha:
 decay, 281–84
 particle, 281, 284
Angular equation, 124–28
Angular momentum, 16, 145–53
 addition of, 165–70
 orbital, 154
 spin, 154
Anomalous magnetic moment, 241
Antibonding, 185
Antisymmetric matrix, 82
Antisymmetric state, 180, 269
Aspect experiment, 379–80
Associated Laguerre polynomial, 139–40
Associated Legendre function, 126–27, 172
Atoms, 186–93
Average:
 over directions, 311
 over polarizations, 311
 value, 7–8
Azimuthal:
 angle, 123
 quantum number, 148
 symmetry, 352, 360

B

Balmer series, 143–44, 243–44
Band structure, 198–203
Baryon, 169
Basis, 77
Bead on a ring, 70, 230–31, 345
Bell, John, 4, 376, 380

- Bell's inequality, 378–79
 Bell's theorem, 4, 376–81
 Berry, Michael, 336–37, 347
 Berry's phase, 333–43, 347–49
 Bessel functions, 130–31
 Binding energy, 138
 Binomial coefficient, 207
 Biot-Savart law, 239
 Blackbody spectrum, 216–18, 312–13
 Bloch, Felix, 193
 Bloch's theorem, 198–201
 Bohm, David, 375
 Bohr, Niels, 3, 5, 137, 143, 158, 374
 Bohr energies, 137, 236
 Bohr formula, 137
 Bohr magneton, 246
 Bohr radius, 137
 Boltzmann factor, 312
 Bonding, 185, 269–70
 Born, Max, 2, 327
 Born approximation, 357, 363–73
 Born series, 371–73
 Born-Oppenheimer approximation, 324
 Born's statistical interpretation, 2
 Bose condensation, 216
 Bose-Einstein distribution, 214
 Boson, 179–81, 214
 Bouncing ball, 292
 Bound state, 51–52, 269–70
 Boundary conditions, 25, 54
 at a delta function, 55
 Bra, 118–19
 Bulk modulus, 198

C

- Canonical:
 commutation relations, 110, 122
 momentum, 176
 Cat paradox, 382–83
 Cauchy's integral formula, 364
 Causal influence, 380–81
 Centrifugal potential, 129
 Chandrasekhar:
 limit, 219
 trial wave function, 273
 Characteristic equation, 88
 Chemical potential, 214–16
 Classical:
 electron radius, 155
 region, 275–77, 284–85
 Clebsch-Gordan:
 coefficients, 167–68, 171–72
 series, 167
 Cofactor, 84
 Coherent perturbation, 310
 "Cold" solid, 195, 197
 Collapse of wave function, 4, 158–59, 374–75, 381–82, 385

- Column matrix, 82
 Commutator, 83, 111
 angular momentum, 145–47, 150, 243, 316–18
 canonical, 110, 122
 position/momentum, 110
 spin, 154
 Commuting operators, 33, 110
 Compatible observables, 110
 Complementarity, 374
 Completeness, 27, 29, 77, 101
 of quantum mechanics, 3, 376
 of a set of functions, 27, 29, 77, 101
 of a vector space, 101
 Components, 77–78
 Conductor, 203
 Configuration, 205
 Conjugate, 83
 Connection formulas, 284–93
 Conservation laws, 12, 113, 118
 angular momentum, 150, 317–18
 energy, 31, 115
 probability, 12, 14
 Continuous spectrum, 50, 101, 106
 Contour integral, 365–66
 Copenhagen interpretation, 3
 Coulomb:
 barrier, 281–82
 potential, 133, 186, 189, 358, 370
 repulsion, 281–82
 Covalent bond, 184–85
 Critical temperature, 216
 Cross-section, 354–55
 Crystal, 200, 255
 Cubic symmetry, 255

D

- de Broglie, Louis, 18
 de Broglie formula, 18
 de Broglie wavelength, 18
 Decay mode, 313
 Degeneracy, 69, 93, 124, 170
 absence of in one dimension, 69–70
 in hydrogen, 139
 pressure, 197–98, 218–19
 electron, 219
 neutron, 219
 Degenerate perturbation theory, 225, 227–35
 Degrees of freedom, 220
 Delta function, 50, 52–53, 58–59, 72, 102, 250, 259, 301
 barrier, 58
 bump, 225, 234
 changing, 340
 interaction, 226
 moving, 72
 shell, 362
 source, 363
 well, 50–60, 72, 258, 260, 296

Derivative operator, 97, 99
 d'Espagnat, Bernard, 3
 Determinant, 84, 91, 116
 Determinate state, 105
 Deuterium, 179, 254–55
 Deuteron, 254–55
 Diagonal matrix, 82, 90, 231
 Diagonalizable matrix, 90
 Differential cross-section, 353–55, 357, 359–60
 Diffuse (d), 190
 Dipole moment:
 electric, 254, 306
 magnetic, 160, 239–41, 250
 Dirac, P. A. M., 102, 106
 Dirac comb, 198–203
 Dirac delta function, 52–53, 59, 102
 Dirac equation, 237, 244
 Dirac notation, 102, 118–19
 Direct integral, 269
 Dirichlet's theorem, 28–29, 49
 Discrete:
 spectrum, 50, 101, 106
 variable, 9, 50
 Dispersion relation, 47
 Displacement operator, 199
 Distinguishable particles, 179, 182–83, 214
 Distribution, 52
 Doping, 203
 Double well, 70, 295–97
 Dual space, 119
 Dynamic phase, 335, 337

E

EPR paradox, 375–76, 379–80
 Effective:
 nuclear charge, 264–65
 potential, 129
 Ehrenfest, Paul, 327
 Ehrenfest's theorem, 17, 43, 122, 150, 162, 175
 Eigenfunction, 97
 Eigenvalue, 87–88, 93
 angular momentum, 148–49
 spin, 155
 Eigenvector, 87–88, 93
 Einstein, Albert, 3, 308–9, 375, 380
 Einstein-Podolsky-Rosen paradox, 375–76, 379–80
 Einstein's A and B coefficients, 311–12
 Einstein's mass-energy formula, 283
 Electric dipole:
 moment, 254, 306
 radiation, 318–19, 322
 Electric field, 254, 301, 307
 Electromagnetic wave, 306–7
 Element (of matrix), 81
 Energy, 22–23
 allowed, *see* Allowed energy
 binding, 138

 electromagnetic field, 309
 ionization, 138, 261, 265
 photon, 143, 216
 Energy-time uncertainty principle, 112–16, 118, 321
 Ensemble, 14–15, 382, 385
 Equilibrium, 204, 270
 Equipartition theorem, 220
 Ethereal influence, 381
 Even function, 24, 26, 39, 61
 Exchange integral, 269
 Excited state, 26, 138–39, 261
 helium, 187–88
 lifetime, 313
 Euler's formula, 29
 Exchange:
 force, 182–85
 operator, 180
 Exclusion principle, 180, 189, 193, 195, 203
 Expectation value, 7, 9, 16
 rate-of-change, 113

F

Fermi, Enrico:
 Fermi-Dirac distribution, 214–15
 Fermi energy, 196, 214–15, 218
 Fermi surface, 196
 Fermi temperature, 197
 Fermi's golden rule, 311
 Fermion, 179–81, 214
 Feynman, Richard, *iii*
 Feynman diagram, 372
 Feynman-Hellman theorem, 252–53
 Fine structure:
 constant, 235–36
 hydrogen, 235–44
 Finite:
 spherical well, 133
 square well, 60–67, 373
 First Born approximation, 367–70
 First-order correction, 222, 302
 energy, 223, 261
 wave function, 225
 Flopping, 306, 310
 Flux quantization, 345
 Forbidden:
 gap, 201–2
 transition, 318, 322
 Foucault pendulum, 333–34
 Fourier series, 28
 Fourier transform, 46
 Fourier's trick, 28, 106–7
 Free electron:
 density, 196
 gas, 193–98
 Free particle, 44–50, 69
 moving, 69
 stationary, 50

Function space, 95
 Fundamental (f), 190
 Fundamental assumption of statistical mechanics, 204
 Fusion, 273

G

g -factor, 246, 250, 225
 deuteron, 255
 electron, 241, 250
 Landé, 246, 250
 proton, 250
 Gamma function, 216
 Gamow, George, 281
 Gamow theory of alpha decay, 281–84
 Gap, 201–2
 Gauge invariance, 175–76, 349
 Gauge transformation, 175, 343
 Gaussian, 11, 50, 69, 112, 257–58, 260, 271
 Generalized:
 function, 52
 statistical interpretation, 104–5
 uncertainty principle, 108–9
 Generating function, 44
 Generator, 118
 of rotations, 173
 of translations in space, 118
 of translations in time, 118
 Geometric phase, 335–40
 Golden rule, 311
 “Good” states, 228–31
 Gradient, 150
 Gram-Schmidt procedure, 79
 Graphical solution, 62–63
 Green’s function, 363, 366, 373
 Ground state, 26, 35
 delta-function well, 55, 258
 electromagnetic field, 308–9
 finite square well, 62, 64
 harmonic oscillator, 35, 40, 257–58, 260
 helium, 187–88, 261–66
 hydrogen:
 atom, 138, 171, 251, 367
 ion, 265, 272–73
 molecule ion, 266–70
 infinite square well, 26, 259–60
 lithium ion, 265
 upper bound, 256, 261
 Group:
 theory, 169
 velocity, 47–48
 Gyromagnetic ratio, 160, 240, 244, 250

H

Half-harmonic oscillator, 68, 289–90
 Half-integer angular momentum, 149, 153, 173–74, 179
 Half-life, 315

Hamiltonian, 22, 120
 atomic, 186
 charged particle in
 electric field, 306
 electromagnetic field, 174, 343
 helium, 187, 261
 hydrogen molecule ion, 266
 magnetic dipole in magnetic field, 160, 239, 330
 Hankel functions, 358–59
 Hannay’s angle, 335
 Hard sphere, 353–55, 361–62
 Harmonic oscillator, 31–44, 70–71, 117, 225–26, 257–58
 driven, 349–50
 radiation from, 313–15
 three-dimensional, 170, 272
 Heisenberg, Werner, 5, 18, 383
 Heisenberg uncertainty principle, 18, 110, 112, 123
 Helium, 187–89, 261–66
 “Helium-like” systems, 272
 Helmholtz equation, 363, 366
 Hermite polynomials, 41, 43–44
 Hermitian:
 conjugate, 83, 92
 matrix, 83
 transformation, 92–93
 Hidden variables, 3, 376–80, 385
 Hilbert space, 100–1
 Histogram, 6, 8, 15
 Hole, 203
 Hooke’s law, 31, 272
 Hund’s rules, 191–93
 Hydrogen atom, 113–44
 allowed energies, 137
 fine structure, 235–44
 ground state, 138, 171, 251, 367
 hyperfine splitting, 235–36, 250–52
 radius, 137
 relativistic correction, 235–39
 spectrum, 143–44
 spin-orbit coupling, 235, 239–42
 spin-spin coupling, 250–52
 wavefunctions, 139
 Hydrogen ion, 265, 272–73
 Hydrogen molecule, 184–85
 Hydrogen molecule ion, 266–70
 Hydrogenic atom, 144, 188–89
 Hyperfine splitting, 235–36, 250–52

I

Identical particles, 177–220
 Impact parameter, 352, 371
 Impulse approximation, 371
 Incident wave, 57
 Incoherent perturbation, 309–11
 Incompatible observables, 110
 Incompleteness, 3, 376, 379
 Indeterminacy, 3, 158–59, 381

Indistinguishable particles, 179–80
 Infinite spherical well, 129–33
 Infinite square well, 24–31
 expanding, 116–17, 324–26, 340
 three particles in, 204–6
 three-dimensional, 193–95
 two particles in, 181
 two-dimensional, 218
 Inner product, 78, 95
 space, 78
 Insulator, 203
 Integral form of Schrödinger equation, 366, 373
 Integration by parts, 15
 Intrinsic angular momentum, 154
 Inverse:
 beta decay, 219
 Fourier transform, 46
 matrix, 84
 Ionization, 138, 261, 265

J

Jordan, Pascual, 3

K

Ket, 118–19
 Kinetic energy, 16–17
 relativistic, 236
 Kramers' relation, 253
 Kronecker delta, 27–28, 102
 Kronig-Penney model, 200–1

L

LCAO technique, 267
 Ladder operators, 32–34
 angular momentum, 147–49, 151
 harmonic oscillator, 33–35
 Lagrange multiplier, 209–10, 212
 Laguerre polynomial, 139–40
 Lamb shift, 235–36
 Landé g -factor, 246, 250
 Laplacian, 122
 Larmor:
 formula, 314
 frequency, 162
 precession, 160–62
 Laser, 308
 Legendre polynomial, 96, 99, 126
 Levi-Civita symbol, 159
 Lifetime, 14, 71, 114–15, 283–84, 313, 315
 Linear:
 combination, 23, 77, 382
 of atomic orbitals, 267
 independence, 69, 77
 operator, 146

 potential, 292
 transformation, 80, 97
 Linearized potential, 285–86
 Locality, 376, 380–81
 Localized potential, 66, 358–59
 Lorentz force law, 160, 162, 174–75
 Low energy scattering, 368
 Lowering operator, 33–34, 147–49, 151
 Luminosity, 355
 Lyman series, 143–44

M

Macroscopic object, 382–83
 Magnetic dipole, 160, 239
 energy of, 160
 force on, 162
 moment, 160, 240–41, 250
 anomalous, 241
 transition, 322
 Magnetic:
 energy, 160, 309
 field, 160, 174, 307, 339–45
 flux, 339–40, 344, 349
 force, 162, 174–75
 quantum number, 125, 127, 191, 317
 Many worlds interpretation, 385
 Matrix, 81
 antisymmetric, 82
 column, 82
 diagonal, 90
 element, 81, 103, 229
 Hermitian, 83
 imaginary, 83
 inverse, 84
 real, 83
 row, 82
 singular, 84
 skew-Hermitian, 83
 symmetric, 82
 unit, 84
 unitary, 84
 zero, 88
 Maxwell-Boltzmann distribution, 214
 Mean value, 7–8
 Measurement, 3–5, 105, 158–59, 164, 381–83, 385
 Median value, 7–8
 Mermin, David, 3, 381
 Meson, 169, 375
 Metastable state, 318
 Minimum-uncertainty wave packet, 111–12
 Molecule, 70, 184–85
 Momentum, 14–17, 121, 275
 operator, 16, 107, 121, 176
 space, 107, 117, 171
 Monochromatic perturbation, 309
 Most probable:
 configuration, 205–6, 209–12
 occupation numbers, 211–12

value, 7–8
 Muon, 179, 252, 273
 Muon-catalysed fusion, 273
 Muonic hydrogen, 179, 252
 Muonium, 252

N

Neutrino oscillations, 120
 Neutron star, 219
 Node, 26
 Nomenclature, atomic, 190–92
 Nonholonomic process, 333–35
 Nonlocality, 380–81
 Non-normalizable function, 11, 45, 50
 Norm, 78
 Normalization, 11–14, 79, 122, 127
 of radial wave function, 127, 129
 of spherical harmonics, 127–28
 of spinors, 157
 of two-particle wave function, 177
 “Normalization,” 102
 Null vector, 76, 88

O

Observable, 104, 106
 incompatible, 110
 Observer, 5, 382
 Occupation number, 205, 211
 Operator, 16, 22, 97
 angular momentum, 145, 151
 derivative, 97, 99
 displacement, 199
 exchange, 180
 gradient, 150
 ladder, 32–35, 147–49, 151
 linear, 146
 lowering, 33–34, 147, 151
 momentum, 16, 107
 position, 16, 98–99, 107
 projection, 119
 raising, 33–34, 147, 151
 Orbital, 189, 267
 Orbital angular momentum, 154
 Orthodox position, 3–4, 374–75
 Orthogonal, 27, 79
 Orthogonalization, 79
 Orthohelium, 188–89
 Orthonormal, 27, 79
 “Orthonormal,” 106–7
 Orthonormality:
 hydrogen wave functions, 140–41
 Legendre polynomials, 128
 spherical harmonics, 128
 Orthorhombic symmetry, 255
 Overlap integral, 268

P

Parahelium, 188–89
 Partial wave:
 amplitude, 359–60
 analysis, 357–62
 Paschen series, 143–44
 Paschen-Back effect, 246
 Patching region, 285, 288
 Pauli, Wolfgang, 4
 Pauli exclusion principle, 180, 189, 193, 195, 203
 Pauli spin matrices, 156, 159
 Periodic potential, 198–99
 Periodic table, 189–93
 Perturbation theory:
 time-dependent, 298–322
 time-independent, 221–55
 Phase:
 wave function, 11, 26, 30, 175–76, 275, 277, 320
 dynamic, 335
 geometric, 336
 velocity, 47–48
 Plancherel’s theorem, 46, 49
 Planck, Max, 143
 Planck’s blackbody formula, 216–18, 309, 312–13
 Planck’s constant, 2
 Planck’s energy formula, 143, 216
 Photon, 143, 216–18, 307–9, 317–18
 Polar angle, 123
 Polarization, 306, 310–11
 Population inversion, 308
 Position operator, 16, 98–99, 107
 Position space, 107, 117
 Positronium, 179, 252
 Potential, 20, 174, 343
 scalar, 174–76, 343
 vector, 174–76, 343–49
 Potential energy, 1, 20, 31
 Potential well:
 no vertical walls, 290–92
 one vertical wall, 289–90
 two vertical walls, 277–78
 Power law potential, 293–94
 Power series expansion, 32, 38, 135
 Preparation of a state, 164
 Principal (p), 190
 Principal quantum number, 137
 Probability, 2, 5–11, 157, 204
 current, 13
 density, 9
 Projection operator, 119
 Propagator, 372

Q

Quantum:
 dynamics, 298
 electrodynamics, 307

Quantum (*cont.*)

- jump, 143, 299
 - number, 130, 137
 - azimuthal, 148
 - magnetic, 125, 127, 191, 317
 - principal, 137
 - statics, 298
 - statistical mechanics, 204–18
 - Zeno effect, 383–85
- Quark, 169

R

- Rabi flopping frequency, 306
- Radial:
 - equation, 129–33
 - wave function, 123, 129, 133
 - hydrogen, 133–41
 - infinite spherical well, 131
- Radiation zone, 358
- Raising operator, 33–34, 147–49, 151
- Rayleigh's formula, 361
- Realist position, 3–4, 374–75, 379–80
- Rectangular barrier, 65, 280–81, 283
- Recursion formula, 39, 138
- Reduced mass, 178
- Reflected wave, 57
- Reflection coefficient, 57, 67, 73, 373
- Reflectionless potential, 73
- Relativistic correction, 235–39
- Riemann zeta function, 108, 216
- Rigid rotor, 153
- Rodrigues formula, 43, 126
- Rotating wave approximation, 305–6
- Row matrix, 82
- "Rubber band" helium, 272
- Rutherford scattering, 355, 370, 373
- Rydberg:
 - constant, 143
 - formula, 143

S

- S matrix, 66–68, 73
 - Scalar, 75
 - Scattering:
 - amplitude, 356–57, 360
 - angle, 352, 371
 - center, 352, 371
 - cross-section, 354, 360
 - differential cross-section, 353–55, 357, 359–60
 - in one dimension, 51–52, 56, 62, 66, 280–81, 293
 - from delta function, 56–59, 373
 - from finite square well, 62–64, 67, 373
 - from rectangular barrier, 65, 280–81, 283
 - from step function, 65, 69
 - in three dimensions, 352–73
 - from delta-function shell, 362
 - from hard sphere, 353–55, 361–62
 - from soft sphere, 369, 373
 - low energy, 368
 - Rutherford, 370, 373
 - spherically symmetrical, 369–70
 - Yukawa, 370
 - matrix, 66–68
 - state, 51–52, 56, 62
- Schrödinger, Erwin, 1, 71, 382
- Schrödinger equation, 1–5, 12, 22–23, 33, 121–22
 - integral form, 363–67, 373
 - time dependent, 1–5, 12, 22, 120–22, 177, 298
 - time independent, 20–74, 33, 122, 178, 289
 - two-particle, 177–78
 - with vector potential, 174
 - Schrödinger's cat, 382–83
 - Schwarz inequality, 79–80
 - Screening, 190, 264–65
 - Sech-squared potential, 72, 294
 - Second-order correction, 222, 226–27, 302–3
 - Selection rules, 315–18
 - Semiconductor, 203
 - Separable solutions, 22–23, 123, 125
 - Separation of variables, 20, 123–25
 - Sharp (*s*), 190
 - Shell, 190
 - Shielding, 190, 264–65, 273
 - Similar matrices, 85
 - Simple harmonic oscillator, 25
 - Singlet state, 166, 171, 185, 251
 - Singular matrix, 84
 - Sinusoidal perturbation, 303–6
 - Skew-Hermitian matrix, 83
 - Slater determinant, 186
 - Soft-sphere scattering, 369, 373
 - Solids, 193–203
 - Sommerfeld, Arnold, 193
 - Spectral decomposition, 119
 - Spherical:
 - Bessel functions, 130–32
 - coordinates, 123
 - Hankel functions, 358–59
 - harmonics, 127–28, 152
 - Neumann functions, 130–32
 - wave, 356
 - well:
 - finite, 133
 - infinite, 129–33
 - Spectrum, 101, 106
 - blackbody, 217–18
 - hydrogen, 143–44
 - Spin, 154–70
 - down, 155–56
 - matrices, 156, 160, 172
 - one, 160
 - one-half, 155–60
 - three-halves, 176
 - up, 155–56
 - Spin-orbit coupling, 235, 239–42

Spin-spin coupling, 250–51
 Spinor, 155
 Spontaneous emission, 307, 311–13
 Square well, 24, 60
 finite, 60–67, 373
 infinite, 24–31
 Square-integrable, 11, 95
 Standard deviation, 8–9
 Stark effect, 254
 State preparation, 164
 Stationary state, 22
 Statistical:
 interpretation, 2, 11, 104–5
 mechanics, 204–18
 Stefan-Boltzmann law, 217
 Step function, 59, 65, 69, 259
 Stern-Gerlach experiment, 162–65
 Stimulated emission, 307–9
 Stirling's approximation, 210, 212
 Superconductor, 345
 Superluminal influence, 380–81
 Symmetric:
 matrix, 82
 state, 180, 267
 Symmetrization, 180

T

Taylor series, 31, 116, 173
 Temperature, 204, 213
 Tetragonal symmetry, 255
 Thermal equilibrium, 204, 312–13
 Thomas precession, 241
 Time derivative of expectation value, 113
 Time-dependent:
 perturbation theory, 298–322
 Schrödinger equation, 1–5, 12, 22, 120–22, 177, 298
 Time-independent:
 perturbation theory, 221–55
 Schrödinger equation, 20–74, 120–22, 177, 298
 Trace, 85, 91, 116
 Transfer matrix, 73
 Transition, 143, 298, 300, 329
 allowed, 322
 electric dipole, 318–19, 322
 electric quadrupole, 322
 forbidden, 318, 322
 magnetic dipole, 322
 probability, 304–5, 332
 rate, 310
 Translation, 86, 118
 Transmission coefficient, 57, 64–65, 67, 73, 373
 Transmitted wave, 57
 Transpose, 82
 Trial wave function, 257–60, 271, 273
 Triangle inequality, 80
 Triplet state, 166, 185, 251
 Tunneling, 52, 59, 280–84, 293

Turning point, 51, 275, 285, 291
 Twenty-one centimeter line, 251
 Two-level system, 299–306

U

Uncertainty principle, 17–19, 108–10
 energy-time, 112–16, 118, 321
 generalized, 108–9
 Heisenberg, 18, 110, 112, 123
 position-momentum, 18, 110, 112, 123
 Unit matrix, 84
 Unitary:
 matrix, 84
 transformation, 94

V

Valence electron, 193
 Variance, 8
 Variational principle, 256–73
 Vector, 75–76
 potential, 174
 space, 75–76
 Velocity, 15–16, 45, 122, 175
 classical, 45, 48
 group, 47–48
 phase, 47–48
 Vertex factor, 372
 Virial theorem, 117, 170, 238
 von Neumann, John, 102

W

WKB approximation, 274–97
 bound states, 277–78, 289–92
 scattering, 280–81, 293
 spherically symmetric potentials, 294–95
 tunneling, 280–84
 Watched pot effect, 383
 Wave function, 1–2, 11, 20, 22
 collapse, 4, 158–59, 374–75, 381–82, 385
 delta function well, 55
 finite spherical well, 132
 finite square well, 61
 harmonic oscillator, 35, 41
 helium, 187
 hydrogen, 139
 infinite spherical well, 132
 infinite square well, 26
 three-dimensional, 231
 Wave packet, 46–47
 Gaussian, 50, 69, 112
 minimum-uncertainty, 112
 velocity of, 48
 traveling, 69

Wave vector, 194
Wavelength, 16
Wave-particle duality, 374
White dwarf, 218–19
Wien's displacement law, 217
Wigner, Eugene, 5, 383

Y

Yukawa potential, 271, 370

Z

Zeeman effect, 244–50
 intermediate field, 248–49
 strong field, 246–47
 weak field, 245–46
Zeno effect, 383–85
Zero:
 matrix, 88
 vector, 76
Zeta function, 108, 216